

CHALMERS

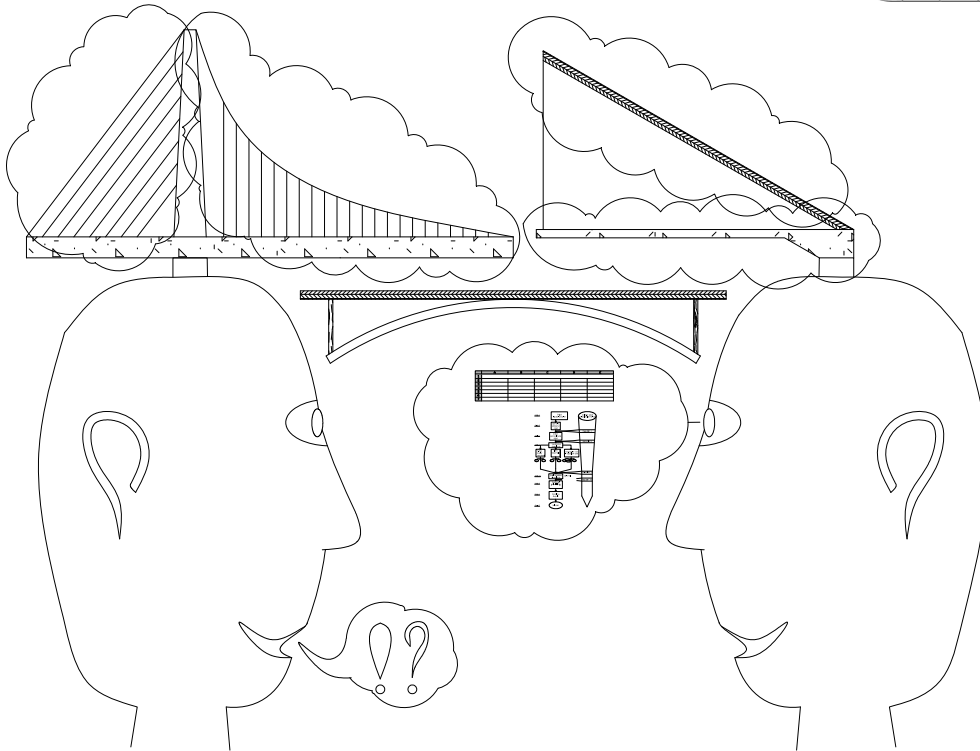

Guidelines for conceptual design of short-span bridges

*Master of Science Thesis in the Master's Programme Structural Engineering and
Building Performance Design*

GEORGI NEDEV
UMAIR KHAN

Department of Civil and Environmental Engineering
Division of Structural Engineering

CHALMERS UNIVERSITY OF TECHNOLOGY
Göteborg, Sweden 2011
Master's Thesis 2011:71

MASTER'S THESIS 2011:71

Guidelines for conceptual design of short-span bridges

*Master of Science Thesis in the Master's Programme Structural Engineering and
Building Performance Design*

GEORGI NEDEV

UMAIR KHAN

Department of Civil and Environmental Engineering
Division of Structural Engineering

CHALMERS UNIVERSITY OF TECHNOLOGY

Göteborg, Sweden 2011

Guidelines for conceptual design of short-span bridges

Master of Science Thesis in the Master's Programme Structural Engineering and Building Performance Design

GEORGI NEDEV

UMAIR KHAN

© GEORGI NEDEV, UMAIR KHAN, 2011

Examensarbete / Institutionen för bygg- och miljöteknik,
Chalmers tekniska högskola 2011:71

Department of Civil and Environmental Engineering
Division of Structural Engineering

Chalmers University of Technology
SE-412 96 Göteborg
Sweden
Telephone: + 46 (0)31-772 1000

Cover:

Abstraction of conceptual design process for bridge design, from Georgi Nedev

Department of Civil and Environmental Engineering, Göteborg, Sweden 2011

Guidelines for conceptual design of short-span bridges

Master of Science Thesis in the Master's Programme Structural Engineering and Building Performance Design

GEORGI NEDEV

UMAIR KHAN

Department of Civil and Environmental Engineering

Division of Structural Engineering

Chalmers University of Technology

ABSTRACT

Although conceptual design is known since decades, there is still limited knowledge on how to apply it, specifically for bridge projects. Most often engineers base their decisions on past experience and standard solutions, which is probably not always the most effective way to approach different problems. Short-span bridges account for most of the solutions for small river crossings, road intersections and so on. Even though they rely mostly on beam or slab solutions, still the choice of material, shape and other properties is not followed by a structured way of thought but rather on previous experience. Ramböll Gothenburg needed a structured procedure for conceptual design. Therefore the purpose of this project was to develop guidelines and a step-by-step procedure, which will support a systematic approach for conceptual design of short-span bridges. In order to achieve this, the most common demands and solutions were identified. Consequently, the link between demands and solutions was searched for, i.e. which solution is appropriate in what situation. The created step-by-step procedure was implemented in Excel toolbox and consists of several modules and is flexible and open for further improvements. This thesis work is based on collected information from literature, continuous interviews with professionals in bridge design, case studies and author's knowledge. Most of the collected information is from the Swedish practice and the consultancy company Ramböll, which slightly limits the reliability of the guidelines and procedure for international use. Further limitations are the maximum length of 30 meters and focus only on road and railway bridges. The developed guidelines were tested on two case studies, which showed a promising tool that gave reasonable results. The developed approach seems to be good for preliminary evaluation of appropriate proposals and also acts as supplementary for the designer mainly as a documentation tool that presents the concepts to the client in a structured way. Further improvements can be refining the toolbox data, increasing the span length limitation and implementing pedestrian bridges.

Key words: conceptual bridge design, short-span bridges, guidelines, Excel toolbox, step-by-step procedure

Contents

ABSTRACT	I
CONTENTS	II
GLOSSARY	V
PREFACE	VII
1 INTRODUCTION	1
1.1 Background	1
1.2 Aim, scope and limitations	2
1.3 Approach	3
1.4 Outline of contents	3
2 CONCEPTUAL DESIGN OF BRIDGES	5
2.1 General on conceptual design	5
2.2 'Five-step' approach for conceptual design	7
2.3 Overview of demands for bridges	11
2.3.1 Technical demands	11
2.3.2 Architectural demands	12
2.3.3 Production demands	13
2.3.4 Economical demands	14
2.3.5 Service life demands	15
2.3.6 Environmental care and sustainability	15
2.4 Current practice in Sweden	16
2.4.1 Swedish building industry	16
2.4.2 Conceptual design in consultancies	17
2.4.3 Common problems faced	19
2.5 Practical lessons learned from the 'Virserum' timber bridge	20
2.6 Conditions and constraints affecting bridge design in Bulgaria, Pakistan and worldwide	24
2.7 Summary	26
3 CLASSIFICATION OF THE MOST TYPICAL DESIGN SITUATIONS	27
3.1 Methodology and approach	27
3.2 Classification of demands, constraints and conditions	28
3.3 Refining of design situations and classification	29

4	DIFFERENT SOLUTIONS FOR SHORT-SPAN BRIDGES	33
4.1	Concrete bridges	33
4.1.1	Slab-frame cast in-situ	33
4.1.2	Beam-frame cast in-situ	35
4.1.3	Integral abutments (jointless bridges)	36
4.1.4	Simply supported slab cast in-situ with end walls	37
4.1.5	Simply supported beam cast in-situ	38
4.1.6	Through concrete beam cast in-situ – flat type	38
4.1.7	Through concrete beam cast in-situ – ribbed type	39
4.1.8	Prefabricated prestressed hollow core elements	40
4.1.9	Prefabricated prestressed beam elements	41
4.1.10	Prefabricated pedestrian and bicycle tunnel	42
4.2	Steel bridges	42
4.2.1	Corrugated steel tube	43
4.3	Timber bridges	44
4.3.1	Stress-laminated plate	45
4.3.2	Beam with timber deck	46
4.3.3	Beams with LVL deck	46
4.3.4	Hanging truss	47
4.3.5	Lower arch	48
4.4	Composite bridges	48
4.4.1	Steel I-girders and cast in-situ concrete deck	48
4.4.2	Steel I-girders and prefabricated concrete deck panels	49
4.4.3	Steel I-girders and FRP deck	50
4.4.4	Timber girders and cast in-situ concrete deck	52
4.4.5	'Folded plate system'	53
4.5	Summary	54
5	'DEMAND-SOLUTION' GUIDELINES FOR CONCEPTUAL DESIGN	55
5.1	Approach and limitations	55
5.2	General description and aim	56
5.2.1	Step 1 – Demand case identification	57
5.2.2	Step 2 - Reducing solution space	67
5.2.3	Step 3 - Demand prioritising	70
5.2.4	Step 4 - Ranking of possible bridge types	76
5.3	Comparison between Niemeyer's 'five-step' and 'demand-solution' methodologies	78

6	CASE STUDIES	81
6.1	The Backaå bridge	81
6.1.1	Background	81
6.1.2	Input and results	82
6.1.3	Comparison with the real case	86
6.2	The Bräcke bridge	86
6.2.1	Background	86
6.2.2	Input and results	87
6.2.3	Comparison with the real case	92
6.2.4	Critical remarks	93
6.3	Conclusions	93
7	CONCLUSION	94
7.1	Concluding remarks	94
7.2	Further development	95
	REFERENCES	96
	APPENDIX A: DESCRIPTION OF THE TOOLBOX	B
	APPENDIX B: QUESTIONNAIRES	I
	APPENDIX C: FEEDBACK FOR THE TOOLBOX	L
	APPENDIX D: CASE STUDY RESULTS	N

Glossary

Angle of skew – the angle between the abutments and the centreline of the bridge (see Figure 0.1).

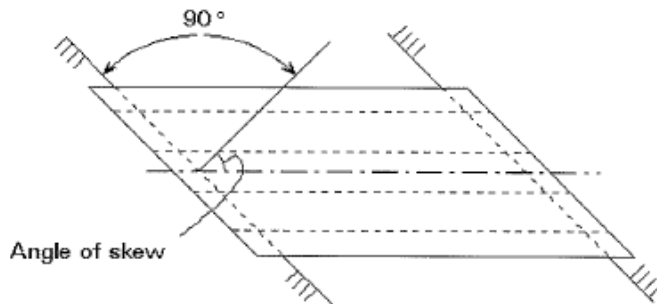

Figure 0.1 Skew angle (skewed bridge), (ESDEP)

Bridge length – the distance between the end-supports (abutments) or walls (for frame bridges), see Figure 0.2.

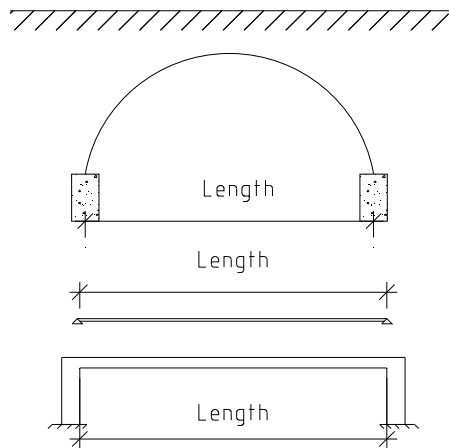

Figure 0.2 Length definition

Conceptual design – the initial and most creative stage of the design process where the basic concept is specified. This stage of design involves creation and choice of concepts by evaluation of different solutions for not entirely specified problem.

Conditions – current state of circumstances and local properties - can be geotechnical, spatial, weather, infrastructure and others. They are interconnected with constraints.

Constraints – restrictions, which affect designer's choices and possibilities. They can be space, time, money, and so on.

Cost overrun – an unexpected excess of costs incurred in relation to a budgeted amount due to an under-estimation of the actual costs during budgeting.

Demand – certain qualities and properties of the product (bridge) representing the desires of the client/society that should be given priority in the design.

Need – a need is psychological or physical thing for organisms to live. In bridge engineering, it is basically the necessity to transport goods and people across an obstacle or to improve the existing connection.

n.a. – not available data or information.

Short-span bridges – bridges that have a length between end supports not more than 30 m. They can have one or multiple spans.

Situation – particular set of conditions, circumstances and constraints. It is based on evaluation of the current state and possibilities (economical, geographic, climate, social).

Superstructure – the structure above the bearings (road deck and surfacing, load-bearing system).

Substructure – the structure below the bearings (abutments, supports, wings, piles and etc.).

Requirements – certain needs to be satisfied in a defined way (by authorities, society, technology). They can be fixed or flexible parameters and at the same time they improve and increase with evolution of mankind. Requirements are necessary to fulfil in order to ensure value and utility of the final product.

Tectonics – architectural aspects of technology.

Trafikverket – the Swedish Transport Administration. Before 2000, two separate administrations existed - Vägverket (Road Administration) and Banverket (Rail Administration).

Preface

This project work was carried out during the period January - June 2011 at Chalmers University of Technology in collaboration with Ramböll's local office in Gothenburg. This master thesis project was a great opportunity to get deeper knowledge about bridges and conceptual design. It was also a chance to see how consultancies work and to learn from them.

We would sincerely like to thank Mattias Hansson, our supervisor from Ramböll, for his incredible and supporting attitude throughout this thesis work along with the whole bridge department. On behalf of Ramböll he provided us with all the necessary resources and support and made us feel like home at our new office. The help from engineers from the bridge department despite their busy schedules is highly appreciated.

Likewise, we would like to express our gratitude to Björn Engström who was our supervisor and examiner at Chalmers. He was always our guide and source of knowledge. His mentorship was keeping us on the right track and giving us motivation.

Our work would not have been so productive without the practical experience gained from interviews with Christer Carlsson from Ramböll Stockholm and talks with specialists and professionals in bridge engineering from Trafikverket.

Last but not least, we would like to thank our families for the unstoping support during our education and their motivating words.

Göteborg, June 2011

Georgi Nedev and Umair Khan

1 Introduction

The word ‘design’, which is commonly used, plays an important role in our daily lives. Every product that is seen and perceived was born first as an idea in someone's mind. This idea probably passed through a design process (procedure). Why a product should be designed in the first place? What is the design process? The answer to the first question is very simple – need naturally provokes solutions, i.e. products to be designed. However, according to Dekker (2000) the answer to the second question is rather complicated, because the design process involves the following four phases:

- 1) Analysis of the problem (needs)
- 2) Conceptual design
- 3) Embodiment design
- 4) Detailed design

This thesis focuses on the first two points – ‘analysis of the problem’ and ‘conceptual design’ of bridges.

1.1 Background

The history of bridges is probably as old as the human civilisation. The idea to build bridges is inspired by the nature itself – they are part of the environment (see Figure 1.1).

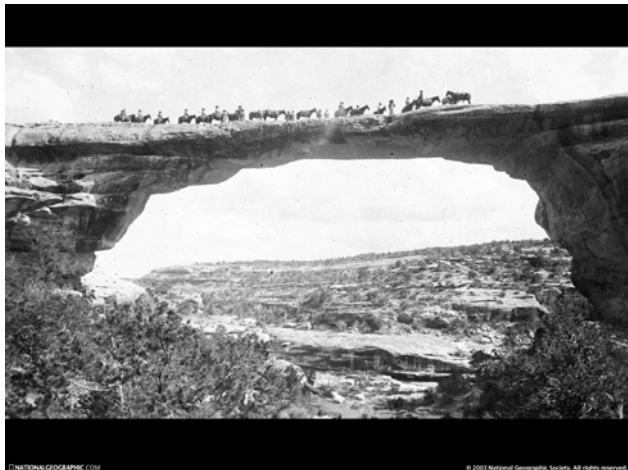

Figure 1.1 Natural bridge (www.nationalgeographic.com)

Bridges are one of the most important and possibly difficult structures in civil engineering. It is no coincidence that they form a special branch of structural engineering and most consultancies have departments working solely on bridge design. In the modern era, bridge engineering has improved tremendously and various factors are taken into account while developing the concept of a new bridge. When society puts increasing demands and requirements on bridges it is the engineer's task and goal to satisfy all of them as much as possible. These factors not only involve the

safety of the structure but also the economy, constructability, inspectability, durability, sustainability, aesthetics and how to achieve the best fit in the landscape and environment. That is why a holistic approach is needed to meet all the requirements and their interdependence.

‘..Engineers operate at the interface between science and society’

~Dean Gordon Brawn

Even though the conceptual phase of design is known to engineers since a long time, there is still a lapse of specific knowledge on how to approach the problem in a more systematic way. Just recently a module of a code for conceptual design was introduced – *fib* (2010): Model code 2010. The following steps of the design are guided by certain rules, codes or guidelines – among these the Swedish specification Vägverket (2009) (TK Bro), which take into account the Eurocodes, Vägverket (2004) (BRO 2004, not valid any more but used as a supplementary document), and the publications of the Swedish Transport Administration (Trafikverket) and so on. Different authors have tried to look at the problem from different perspectives - Kroll (2001), Löqvist (1994), Dekker (2000), Niemeyer (2003), *fib* (2000).

During the 60’s and 70’s a vast amount of the bridges built in Sweden were designed from a mainly structural engineers’ perspective, i.e. solutions were based on the most efficient static scheme and use of material. Architectural aspects during conceptual design were missing, which was realised by the society and its representative authorities later on. That is one reason why a holistic approach was needed and efforts have been made to implement it. More information can be found in publications of the Swedish Transport Administration: Vägverket (1997) and Vägverket (1999).

The problem Ramboll’s conceptual design engineers in Gothenburg was facing was lack of a structured methodology to work especially during discussions and meetings with the client. They needed an interactive tool that visualizes and supports their decisions and choices and convinces the client why a certain alternative is proposed. Moreover, information and experience were not documented systematically but the information was only in the designer’s memory.

1.2 Aim, scope and limitations

The main aim of this research was to develop an approach and guidelines for conceptual design of short-span bridges. The final outcome of the thesis should be a step-by-step procedure for approaching conceptual design, which will provide engineers with a suggestion for the most suitable solutions for given input parameters.

The objective is to develop a step-by-step design procedure with guidelines including:

- A classification of different situations (demands, conditions, constraints)
- A compilation of the most common and appropriate solutions (structural systems) for short-span bridges, including some new trends and international knowledge
- A prioritising-of-demands tree identifying the most important aspects for a specific project

- Ranking (or evaluation) matrixes to compare the alternative solutions
- Recommendations for further evaluation of the chosen concept

The scope of the thesis is 'short-span bridges' with total length up to 30 meters. Even though, the work is further restricted by the following limitations:

- The developed design procedure is generalised and cannot handle well rare and unusual cases (with very special requirements or conditions)
- The knowledge acquired from practising engineers is mostly from Ramböll's consultants
- The big branch of pedestrian bridges is not covered in this thesis work

Even though short-span bridges represent a narrow scope they account for a big part of the built bridges today.

1.3 Approach

This project used two main sources of information and knowledge acquisition – literature studies and interviews with specialists in the field. First, the literature studies were done and after that a series of interviews was carried out. The interviewed persons represented two main parties involved in conceptual design – engineers (designers) and clients. Complementary knowledge was also gained by constant oral discussions with engineers from Ramböll's office and a short study trip along E6 highway north of Gothenburg.

All the information found was used to identify the important factors influencing the design and the reasoning behind decisions. Categorisation of the most common design situations in practice was done. Furthermore, the most suitable and bridge types for short-span bridges were proposed. Afterwards an interactive toolbox was developed to link these demands cases with promising solutions. Certain make-or-brake issues were searched for and implemented. A toolbox was created to be flexible and easy to follow. Moreover, the focus was on the practical use and especially its value when shown to the client. Finally, these guidelines were developed by an iterative process and continuous re-evaluation. Two short case studies were done to test the toolbox and the methodology as a whole.

1.4 Outline of contents

This thesis consists of seven chapters, a list of references and appendices. It covers an overview of the existing conceptual design knowledge and proposes a new approach for conceptual design of bridges with total length up to 30 meters proposing the most appropriate solutions. Chapters 3, 4, 5 and 7 were written by Georgi Nedev while the remaining chapters by Umair Khan. The Excel toolbox was developed by the two authors together.

Chapter 2 gives an overview of conceptual design as a process based on research work of different authors and how it is approached currently in Swedish consultancies.

Chapter 3 classifies and summarises the most common design situations for short-span bridges based on literature studies and interviews with practising engineers.

Chapter 4 lists the most common and appropriate solutions for short-span bridges, though only for road and railway traffic.

Chapter 5 presents the developed step-by-step ('demand-solution') approach for conceptual design

Chapter 6 presents a short case-study, concerning the application of the 'demand-solution' methodology on a real project.

Chapter 7 gives summary and conclusions and proposes suggestions for further research on the topic.

2 Conceptual design of bridges

This chapter gives an introduction to the conceptual design process itself and provides understanding on the complexity of the problem.

‘Engineering problems are under-defined; there are many solutions, good, bad and indifferent. The art is to arrive at a good solution. This is a creative activity, involving imagination, intuition and deliberate choice.’

~Ove Arup

Conceptual engineering starts with specification of the design intentions, which is indeed one of the most critical parts of bridge engineering. These intentions and demands most often change during the process, so the conceptual design is always an iterative process. In addition, to come up with various possible solutions and select the most suitable ones for a specific task is also very challenging. However, the main question is how to select the best alternative, which manages to meet all the needs as much as possible at the same time. In this modern era where sustainability is in focus the demands of the society have increased so conceptual engineering plays a vital role to build a structure, which is integrated into the environment and serves the stakeholders in the most efficient, economical and elegant way.

‘Engineering is the art of modelling materials we do not wholly understand, into shapes we cannot precisely analyse so as to withstand forces we cannot properly assess, in such a way that the public has no reason to suspect the extent of our ignorance.’

~Dr A.R Dykes

2.1 General on conceptual design

Conceptual design is probably the most inspiring part of engineers’ tasks but at the same time the most demanding of all. Indeed, the more experienced the bridge engineer is, the more easily he or she can see the solution in his or her head and does not need to start from scratch. The contradiction becomes obvious as conceptual design has to be the most creative part of the design. On one hand, engineers do not need to invent the wheel every time they approach a problem. On the other hand, if they already predefine the answer in their mind, they are already neglecting most of the other alternatives, which reduces the possibilities for new inventions and improvement of solutions.

In an enquiry study carried out by Dekker (2000), engineers in Sweden stated that the biggest obstacle that causes problem is shortage of time. They gave different reasons for that, but the conclusion was that engineers need more time/money in order to create and produce better and more optimal structures. This can be observed in Figure 2.1 where it is obvious that if more time is spent for conceptual design, better and more appropriate solutions would be found. The possibility to save money in the long perspective and creating additional value with little extra cost can be clearly found.

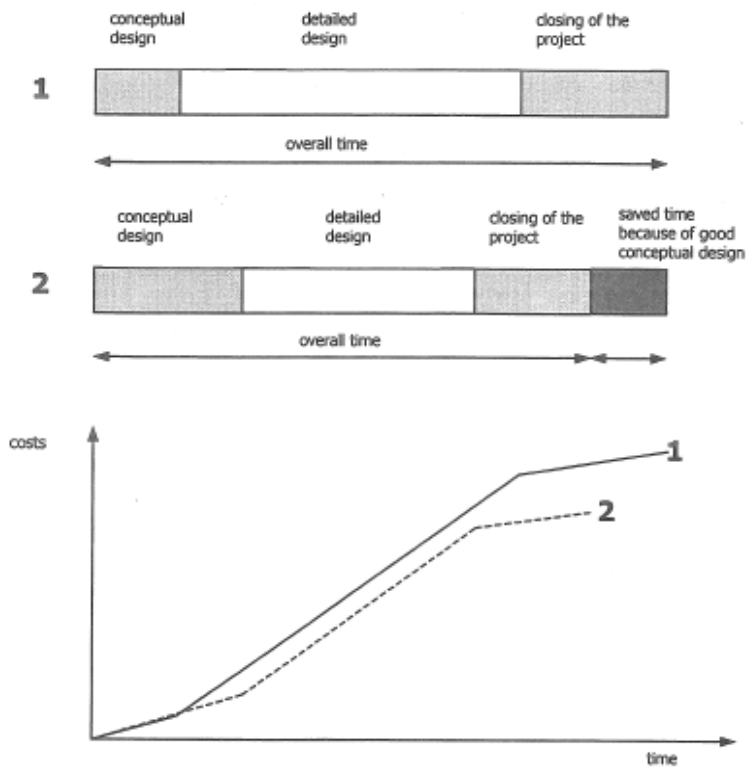

Figure 2.1 Effect of time spent on conceptual design (Dekker 2000)

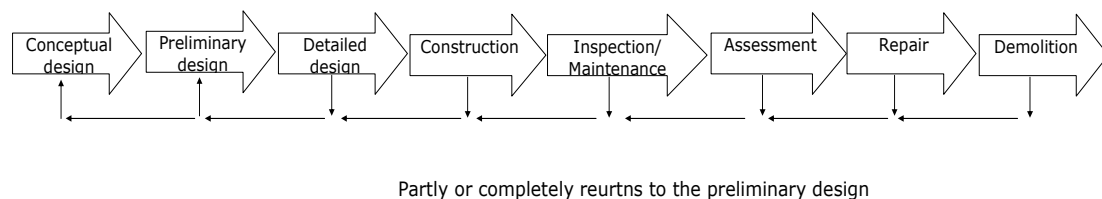

Figure 2.2 Bridge lifecycle (Niemeyer 2003)

‘Architecture is the context of conceptual design’

~Dan Engström

When the word conceptual design emerges, it is often the architect who is linked with it. Generally, the architect is the person delivering the aesthetic qualities and use of space. However, as bridge engineering is quite a specific task, the situation is somewhat different. Opposite to residential, public and other buildings, bridges are mainly structural products and it is the structural engineer who has at the same time the highest decision making power and responsibility compared to other specialists (architect, traffic safety planner, environmental engineer etc.). This is particularly true for short-span bridges as they usually do not have exceptionally high demands on aesthetics or attractive appearance. On the other hand, if proper thought is given to small details and shapes, very good results can be achieved with little additional cost. This is what the Swedish authorities realised during the 80’s and started to express aesthetical demands concerning their bridges. With the current advanced technology, the designer needs to have the knowledge and ambition to make the bridge as aesthetically pleasing as possible without excessive costs for the client and society.

2.2 'Five-step' approach for conceptual design

In this section the methodology by Niemeyer (2003) is explained shortly. The methodology is illustrated in Figure 2.3 which presents an overview of the whole process of conceptual design – from need definition to proposal of the best solution. It was developed by combining the methodologies of Kroll et al. (2001) and of Engström (2002). The methodology of Kroll et al (2001) is more theoretical and is useful for understanding of problem solving theory and creation of innovative solutions, while Engström proposed a practical approach to solve the problem and his methodology is suitable when used as a toolbox.

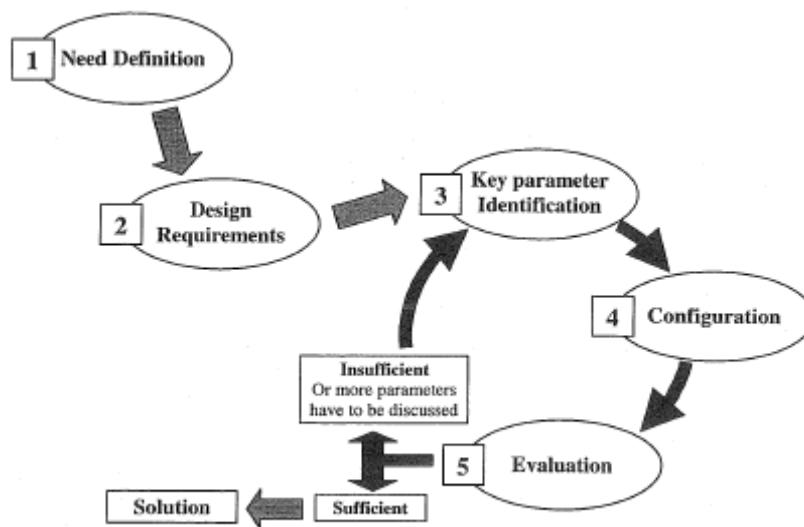

Figure 2.3 Five-step methodology proposed by Niemeyer (2003)

Since the methodology of Niemeyer was developed generally for the building industry and not focusing on bridges only, the amount of uncertainties is bigger. Moreover, a further optimisation has to be done to adapt it for conceptual design of short-span bridges, where the solution space is not that wide. Nevertheless, a short description of the 'five-step' methodology is presented below:

1. **'Need definition'** – the actual start of the project. The basic needs with regard to where the bridge will be situated and what type of traffic will run on it are specified. This part makes all the parties familiar with the task and the main goals. It is very important to identify the actual needs without thinking about solutions. Need identification independent of solution space can lead to an innovative design. After identification of the needs, they have to be analysed, which helps to set the limitations of the project. If the needs are correctly identified then the risk of changing the whole design later during the design phase has been reduced or eliminated. One procedure to identify the real needs is to list all questions and issues systematically.
2. **'Design requirements'** – at this stage the requirements are further clarified and all technical aspects such as codes, legal issues and other are discussed. For example the number of lanes or needed construction height

is specified. All these are called ‘hard’ parameters and every proposed solution has to satisfy them. This step gives a summary of the minimum needed functions and constraints. Design requirements do not mean checking the performance and properties of the product, since this can lead towards predefined solutions, which again can be a hurdle for innovative design. Since design requirements guide the design process, the quality of the product is directly influenced by them.

3. **‘Key parameter identification’** – simplification of the task and transformation of it into a more abstract problem. By identifying the most important points to the client, generation of ideas and solutions is made. These solutions should try to satisfy the key parameters as much as possible. Simplification is done by depriving the less important factors or removing those factors, which are not important in the beginning or during the conceptual design phase but can be relevant in the later stages. Secondly, trying to solve the most critical problems first is the way to be able to continue developing the concept further.
4. **‘Configuration’** – more detailed information about the proposed solutions with sketches, preliminary calculations and explanations is worked out. For the evaluation of the physical configuration it is important to define some parameters like dimensions and material choice. Since this is a repeated process, several options will arise. Moreover, opposite to parameter identification, configuration is quite a divergent process (Figure 2.4).

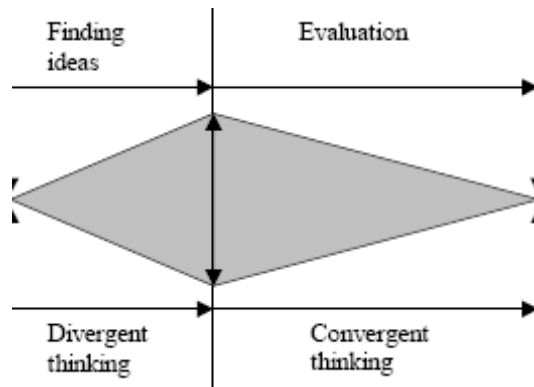

Figure 2.4 Divergent and convergent thinking for solving problems, Niemeyer (2003)

5. **‘Evaluation’** –the proposed solutions in step 4 are evaluated and ranked according to different parameters.

One of the most crucial steps is the ‘Key parameter identification’. The solutions that remain as promising must be further evaluated and compared. In order to do that the engineer must know which parameters and qualities of a specific bridge are of greater importance for the client.

Dekker (2000) proposed four different ways to achieve this:

- Ranking matrix – all the parameters are compared to each other (Figure 2.5). For each comparison the parameter is given one of three possible values:
 - + More important
 - Less important
 - 0 Equally important

After this all the values are summed and the parameters ranked. This method gives very logical outcome by comparing parameters to each other instead of randomly distributing a number of points between them. However, it requires more time and effort.

Objectives.	1	2	3	4	5	6	7	8	sum	ranking
1. Security.	0	+	+	+	-	+	+	-	5	2/3
2. Resisting forces.	-	0	-	-	-	+	-	-	1	7
3. Recognition.	-	+	0	-	+	+	-	-	3	4/5
4. Giving sphere.	-	+	+	0	-	+	+	-	4	6
5. Fitting in environment.	+	+	-	+	0	+	+	-	5	2/3
6. Other building parts.	-	-	-	-	-	0	-	-	0	8
7. Easy maintenance.	-	+	+	-	-	+	0	-	3	4/5
8. Controlling inside climate.	+	+	+	+	+	+	+	0	7	1

Figure 2.5 Ranking matrix, from Dekker (2000)

- Discursive ranking (Figure 2.6) – the different parameters are given a ranking on various scales (1 to 10, 1 to 100) depending on the designer. The choice follows the needed accuracy or preferences. The most important parameter receives the highest amount of points and vice versa. If two objectives are considered equally important, they should receive an equal score.

10	B
9	
8	
7	C
6	
5	D
4	A
3	
2	E
1	

Figure 2.6 Discursive ranking, from Dekker (2000)

- Distribution of values using fixed number of points (Figure 2.7) – this approach distributes a limited amount of points among the parameters. Again, it is up to the designer to decide how much importance is put on different parameters, while considering the project specific demands.

B	35
C	25
D	18
A	15
E	7

Figure 2.7 Distribution of values using a fixed number of points, from Dekker (2000). Here 100 points are distributed between parameters A, B, C, D, E.

- Objective tree (Figure 2.8, 2.9) – the most analytical approach, which provides more consistency. Here different levels of parameters are present and only small groups of parameters are compared to each other. The relative weight of a parameter is related to the relative weight of the group of parameters to which it belongs.

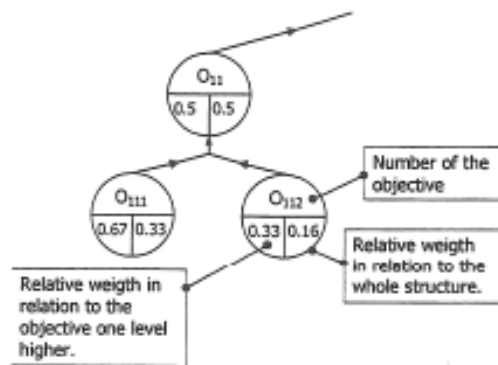

Figure 2.8 Objective tree, from Dekker (2000)

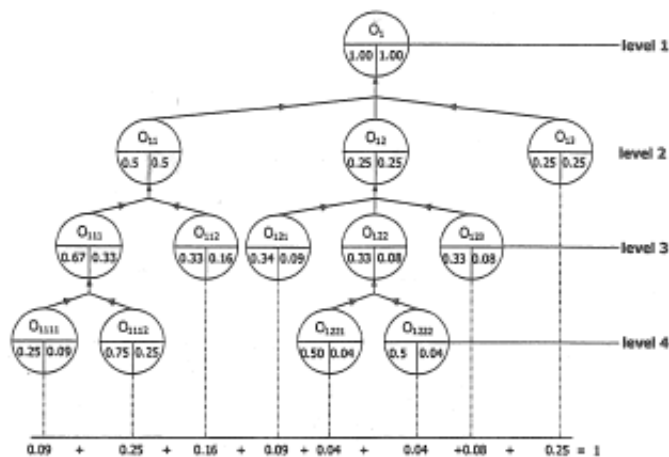

Figure 2.9 General view of the objective tree, from Dekker (2000)

The choice of method depends on the decision of the designers and is not influencing substantially the final results. More important is to take into account that different parameters have different importance for a certain project. For some cases quicker methods such as distribution of values using fixed number of points or discursive

ranking are suitable, while when detailed analysis – objective tree and ranking matrix give better results. According to Dekker (2000), the following factors may affect the choice of evaluation method:

- Available time for evaluation
- Required accuracy of the comparison
- Information available
- Complexity of the problem
- Preferences of the designer or the team of designers

Finally, it is very important to do an evaluation of the results subjectively and analyse the winning alternative. The highest score does not necessarily mean the best option.

2.3 Overview of demands for bridges

Every structure has to meet a wide range of demands. Six main areas were outlined by Engström (2002) for buildings in general and further adapted for bridges by the authors. They are systemised in Figure 2.10 below.

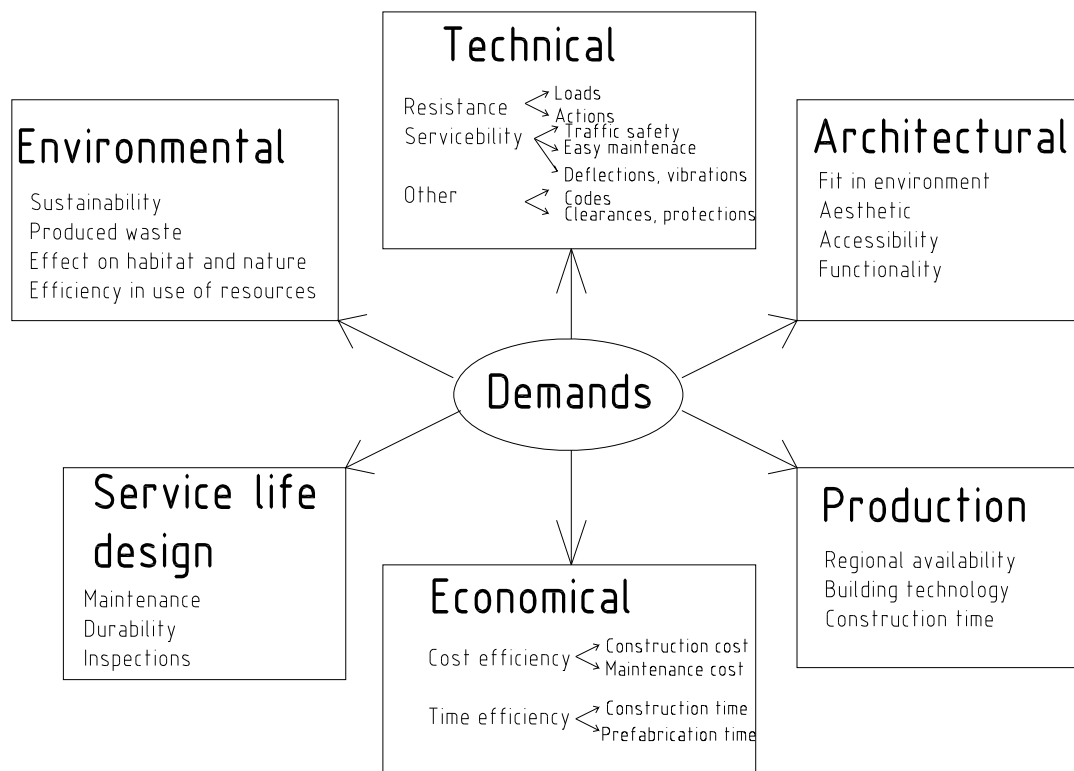

Figure 2.10 Demand tree

2.3.1 Technical demands

These are normally the fixed requirements – they always must be fulfilled and satisfied. The most basic one is the structural load-bearing capacity (resistance) – the

bridge must be safe to use and remain solid and robust and no collapse or partial collapse should happen during the whole lifespan. Moreover, all the imposed loads and other actions must be resisted in a controlled way, i.e. without excessive deflections, vibrations or settlements – serviceability requirements. For example a railway bridge must have limited settlements and deflections as the railway traffic is sensitive to movements and has low tolerances.

Most of these demands and requirements are well described in the codes – recently made compulsory Vägverket (2009) (TK Bro) and the complementary Swedish specification Vägverket (2004) - BRO 04. In these documents a lot of other aspects and requirements are listed as well. Every country has their own codes for design, which engineers strictly follow.

2.3.2 Architectural demands

Aesthetics play an important role in human lives, although often this aspect is either neglected or unrecognised. As bridges, even short-span ones, are human sculptures at a larger scale, they affect our emotions as we interact with them on a daily basis. Furthermore, most often a bridge is designed for a lifespan of at least 100 years, so it will be a part of the built environment for a very long period. That is why it is the engineers' task to satisfy these delicate and subjective demands.

According to Leonhardt (1990), characterising the aesthetic qualities leads to guidelines for designing. Indeed he mentions the following: fulfilment of purpose-function; proportion; order; refining form; integration into environment; surface texture; colour; character; complexity and incorporating nature.

Engström (2010) has proposed three very simple yet fundamental tools to achieve attractive tectonics:

- Profiling – the shapes follow the force flow and load transfer; material is placed only where needed by mechanical demands
- Inner balance – the bridge is approached as a whole entity
- Differentiation – each material or element is used only where it is effective. This creates readability and follows the maxima 'everything ingenious is simple'

Fitting the bridge into the environment (Figure 2.11) and landscape is a part of aesthetics in general. However, for bridges it is a very significant aspect of the appearance of the structure and that is why it should be separated. Often the bridges are placed in the countryside so their contact with nature defines this fit. On the contrary, residential and other buildings have the urban environment to merge with. In order to integrate the new bridge smoothly not only the superstructure type and geometry are important. Secondary parameters such as shadows, colour match and line continuation play an unconscious role in our perception. Bridges should not impose themselves – they have to find their place in the surrounding space like a puzzle piece. All this can be achieved by the help of landscape architects and partly by road engineers.



Figure 2.11 Concept of a landscape bridge, fitting the environment, from <http://www.tallbridgeguy.com>

Apart from fitting in the environment and aesthetics, accessibility is another architectural demand. However, it is mostly concerning pedestrian or fauna¹ bridges or bridges with very complex functions (internal bridges, links between buildings and so on).

The reader is encouraged to find out more information and guidelines for the aesthetical and architectural features of bridges in Leonhardt (1990) and Gottemoeller (2004).

2.3.3 Production demands

The conceptual designer and his or her team need to consider and take into account the location where the new bridge will be built. Local constraints such as lapse of well experienced and equipped contractors can significantly affect the design. For example, a very innovative FRP (carbon-fibre reinforced) deck is not a feasible solution in detached regions with only local construction companies. On the contrary, new reinforcement methods such as prefabricated ‘rolled’ reinforcement (see Figure 2.12) can save up to 90% of placing costs and 40% of reinforcement costs (Bamtec, 2011). They do not require skilled labour and are fast and easy to accomplish. The local situation also affects the choice of construction technology especially for larger projects. That is why it is very good for the designer to know who will be the contractor beforehand or at least have an idea of the possibilities. Last but not least, restriction in building time has quite an important influence on the choice of the structural system and especially the main material. For example, a pedestrian overpass over a railway line must not stop or affect the railway traffic and a prefabricated steel or timber bridge would be very suitable as to avoid extensive false work and work on site.

¹ Fauna bridge - a special type of bridge designed for continuation of natural environment (flora and fauna populations), designed to prevent dividing of natural habitats and assure a natural pass over the new road or railway.



Figure 2.12 Prefabricated 'rolled' reinforcement (Bamtec 2011)

2.3.4 Economical demands

The cost of a bridge is probably the most deciding factor when choosing among alternative solutions. Society always wants good value for money and cost effective structures are the goal of engineers. Since the Swedish Transport Administration (Trafikverket) represents the government and authorities in Sweden, i.e. the client of a bridge project, their goal is always to achieve good economical price without compromise of durability, safety and environmental impact.

The cost of a bridge has to be split in two main parts:

- Construction cost - the price for raw materials, prefabrication, workforce, machinery and others. It is a false assumption to base the decision only on this price, as bridges have a lifespan of at least 50-100 years and their initial price does not represent their long-term costs.
- Maintenance cost – this is the cost for future maintenance, inspections and so on.

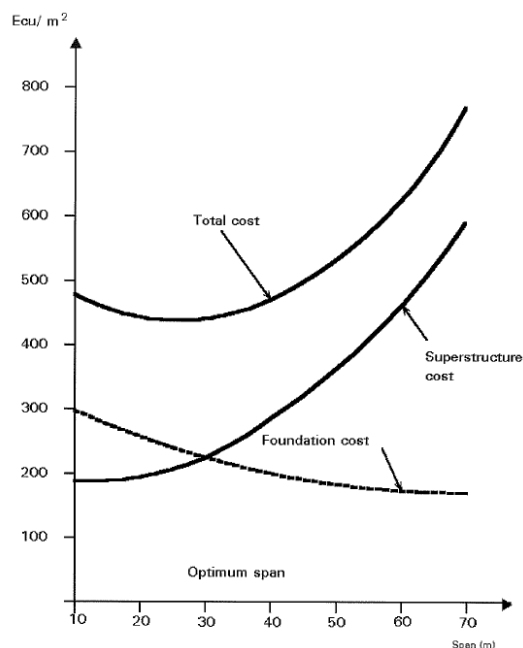

Figure 2.13 Typical cost vs. span graph (from ESDEP Lecture Note WG1B)

A very big part in the cost of a new bridge is due to the foundation. Indeed, for shorter spans the price of foundations is a relatively large part of the total price. That is why the engineers always prefer solutions with as little ground works and extensive foundations as possible. All this can be clearly seen in Figure 2.13 although this example is for viaducts. One example is choice of number of spans. Usually it is cheaper to choose longer spans rather than increase their number. Even though longer span length results in higher deadweight and construction height, more spans mean more foundations and piers which directly affect foundation costs and probably building time. Another important aspect for good economical efficiency is time for construction and manufacturing. As time equals money, the faster the product is completed, the faster the investment can pay off. These demands can steer the choice of a concept to a prefabricated solution rather than to built in-situ one.

The risk of cost overrun is another factor in bridge construction, which has been studied by Flyvbjerg et al. (2002). The average cost overrun in bridge construction was found to be 34%. This shows that it can be better to choose a more expensive solution, but with higher initial quality and less risk of cost overrun.

2.3.5 Service life demands

As mentioned in Section 2.3.4, maintenance cost is a very important parameter when designing a new bridge. Service life demands include as little unforeseen repairs as possible. This is achieved with a proper service life design which includes suitable use of materials and details, plan for maintenance and inspections etc. For example a steel solution needs periodic painting, while a timber bridge needs careful initial detailing of joints to avoid serious problems. Different materials and production techniques achieve the required durability and service life demands in different manner and cost. For example, it is considered that timber bridges satisfy those at a higher cost. The problem is not only technical but sometimes political. A chemical protection called 'Creosote' is vastly used in Norway and Finland to protect timber bridges and ensure their life span. However, it is not allowed by the Swedish authorities due to environmental and health risks. This fact shows that traditions and politics have influence on the choice of bridge type and its design. The mentioned example points out that some demands are interconnected – use of 'Creosote' is due to service life considerations, but is restricted by the environmental demands. To sum up, service life design should be done in a way to assure the safety and serviceability of the bridge throughout its life span.

2.3.6 Environmental care and sustainability

Nowadays bigger and bigger stress is put on sustainability in every aspect of life and construction plays a big role (40%) in the cause of pollution and use of natural resources. New requirements are being imposed for bridges, such as possibility to recycle the bridge, easy disassembly or energy saving production technology. Life cycle management and costs are considered. In many cases there are environmental specialists in the design teams who reflect the needs and restrictions in order to ensure as small environmental impact as possible. These restrictions influence waste disposal, contamination of land and water, flora and fauna considerations and so on. A typical example is that in Sweden it is tried to avoid works in the water, while building bridges. Not only because special permission is often needed, but also because of increased risks and difficulties for the construction. This demand

(constraint) leads to avoiding some solutions with extensive formwork or casting of middle supports in water. In the Swedish design practice, the engineer receives a map of the area for the future road and/or bridge (see Figure 2.14). This map includes information for existence of endangered species, protected fauna or flora, water sources and other.

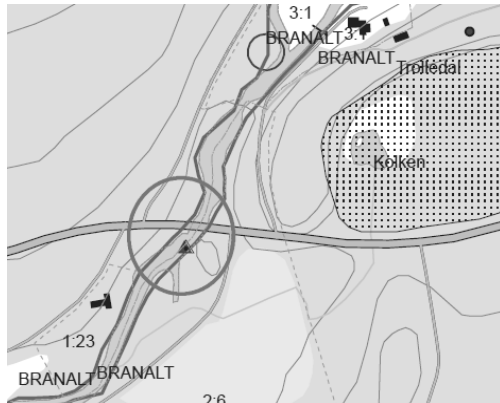

Figure 2.14 Map of environmental aspects (Ramböll)

2.4 Current practice in Sweden

The conclusions presented in this section are mostly based on Dekker (2000) and the interviews conducted with engineers working with conceptual design of bridges. Although Dekker (2000) covered concrete structures and buildings in general, most of the conclusions and remarks are also valid for bridges.

2.4.1 Swedish building industry

In general, conceptual design of short-span bridges is mostly based on experience of the engineers and their continuous dialogue with the client. The predominant client for bridges in Sweden is the Swedish Transport Administration. As a result, Dekker (2000) concludes that a quite good communication between designer and client exists and the conceptual design process is following traditions. Indeed traditions play a vital role as around 90% of the bridges in Sweden are made from concrete. Indeed, Harryson (2002) states: *'the heritage from the craft-based 19th century is still strong in Swedish bridge construction'*.

Critical issues for the design engineer are restrictions with regard to time and money. The initial cost of the bridge is the most deciding factor for the client, since the maintenance cost represents a very small part of the whole price (around 10%). One of the reasons why the initial cost is governing is that infrastructural projects are funded only by the budget and not by any additional incomes such as highway tolls and others. Moreover, the goal of the authorities is to achieve more bridges at lower cost, rather than less but with innovative design or aesthetical and/or other advantages. This makes conceptual design of bridges simpler compared to other types of structures (buildings, facilities and etc.). This is mostly because of the fact that the 'client' is always the same organisation and the requirements are well-known even in advance. Moreover, the Swedish Transport Administration has a long experience in maintenance and operation of bridges and is therefore a very competent client. Even though the Swedish Transport Administration employs bridge specialists as technical

staff members (on the contrary of private residential houses where the 'client' usually lacks sufficient technical knowledge), the client's representative is not always technically experienced.

Apart from these aspects, an important circumstance exists in the building industry in Sweden and it is related to the type of contract, which is commissioned:

- 'Total contract' – in this case the contractor has big freedom and is responsible for the design and construction of the object (bridge). Often the client often has no clear vision and specified requirements. This is why the client commissions a consultancy in order to receive help in forming the frames and requirements for the contractor. The most important factor for conceptual and detailed design is the total cost of the bridge. The two latest conditions lead to limited options and freedom for the designer (consultant). This is because it is the contractor that designs and builds the structure. That is why the cheaper the initial cost is, the better profit will be achieved.
- 'General contract' – here the contractor only produces the already designed structure with little or no influence on the final product. The client in Sweden is almost exquisitely the Swedish Transport Administration and the task is usually not only conceptual design but detailed design as well. After the detailed design is completed, a contractor is found to build the bridge. 'General contract' is the most common form and allows for more freedom for the designers in conceptual design. On the contrary, the contractor is restricted more. This type also has bigger focus on the overall function of the new bridge and takes into account broader aspects.

These different contract forms result in quite different conditions for the conceptual design of buildings. On the contrary, bridge engineering often falls in between both these contract forms and this varies according to the project. For large scale project (motorways, railways) the authorities often commission a whole stretch to the contractor who usually sub-commissions consultants for the design. On the other hand, for smaller junctions and roads for example, an approach closer to 'General contract' is used. Then, the client has a clear idea of the new bridge and the conceptual design consists of providing a solution that satisfies regulations and the client's demands best.

The conclusion is that conceptual design for short-span bridges is not directly affected by the type of contract. The same procedures and methodologies can be used no matter of the case. Moreover, bridges represent a specific type of structures and often the contract cannot be described as 'Total' neither as 'General' contract. Most often the projects are somewhere in between these two options.

2.4.2 Conceptual design in consultancies

Conceptual design is approached differently by each consultancy and also each engineer. Most often conceptual design starts with a brainstorming session comprising of different specialists. A bridge is not an isolated structure and it has to be integrated with the road, landscape and environment. Hence, the bridge engineer starts the work in coordination with road designer, geotechnical engineer and landscape architect, especially for larger projects. Moreover, the society demands safe, economical and

quick solutions with good aesthetical features. That is why the designer always evaluates and assesses different options, while keeping in mind the requirements and demands of the client (society). To identify and understand these demands, the engineers carry out numerous meetings with the clients and between each others. Since economy is one of the most important parameters of the project, it acts as decisive for the conceptual design of bridges. Therefore, design engineers always try to think in a way such that the most economical solution is achieved. This is done by considering different factors: availability of material and skilled labour, structural efficiency and good detailing to minimize the required maintenance etc. Hence, by having strong practical knowledge, designers consider production methods and commercial aspects of the project. The overview of the designer puts together all the information and the input thus providing proposals for economical and efficient solutions. In addition, there are often further specific project requirements, which have to be considered. Similarly, availability of working space at the site, environmental considerations and type of obstacle are some examples of site conditions or constraints.

Only half of the interviewed engineers stated that had a certain procedure for conceptual design (Dekker (2000)). Most often this procedure includes the use of checklists in order to keep track of the work and to avoid missing some aspects. Depending on the project, consultants come up with a number of promising solutions and maybe propose the best one according to their experience. This selection is mostly done by means of discussions and rarely using more complex evaluation methods such as evaluation matrixes, usage-value analysis or controlled convergence (explained in Section 2.2). The final presentation of the proposed solution to the client is made mostly by means of an oral description with optional graphs. An important aspect is that the client knows roughly the solution as a result of the discussions and meetings during the conceptual design phase. This shows the iterative nature of conceptual design.

Swedish authorities are constantly issuing literature in forms of architectural guidelines and other publications. The most used ones concerning bridge design are two handbooks called Bridge design (*Broprojektering*) – one from the Swedish Road Administration (Vägverket 1996:63) and one from the Swedish Rail Administration (Banverket, 2007). They cover general aspects and technical details as well as the most common bridge types. In addition to these, there is a separate specification treating bridge design – TK Bro (Vägverket publ. 2009:27). It provides very detailed information, especially for further stages of design. With the introduction of Eurocode in all EU nations, new trends are arriving. Some solutions that were not allowed by previous National rules are now permitted and other aspects are changing. For example composite solutions consisting of timber beams and concrete deck are now allowed by Eurocode, thus probably giving the engineers a chance to explore it.

A summary of opinions of how to improve and optimise the conceptual design process is presented below (Dekker (2000)):

- Further implementation of Building Information Modelling (BIM) and other methods of documenting previous experience
- Better integration between Final Elements Analysis (FEA), Computer-aided design (CAD) and structural software

- More time and resources should be devoted to conceptual design
- More education of the staff on conceptual design

In the current high-tech world, the construction business and particularly design seems to be somewhat behind other industries, for example automotive or electronic. This is why leadership and company policy have to be adapted to the changing world so that consultancies remain competitive on the market. Use of VR¹ models can also help to give an idea of the bridge and how it fits into the surrounding landscape. Thus, different alternatives can be evaluated and compared and a better understanding can be achieved both for the designer and the client

More detailed information about the conceptual design in Sweden can be found in Dekker (2000).

2.4.3 Common problems faced

According to Dekker (2000), the biggest problem engineers (60%) face while creating a solution for a bridge is the lack of time for finding the most optimal solution. Often a too short time period is available for conceptual design and naturally engineers tend to look back at previous projects or use their own experience in order to quickly provide reliable and cost effective solutions. Only half of the interviewed engineers answered that they use a structured procedure for conceptual design, Dekker (2000).

Consequently, during the interviews carried out by the Authors, it became clear that the engineers tend not to remember all of the alternatives they had in mind and reckon only the final conceptual proposal. Another discovered issue was the difficulties when estimating and reasoning the cost of a new structure both for construction and maintenance. Knowledge in this area is restricted and as in every other market area the economic situation changes constantly (price of raw materials, labour, machinery etc.). Unclear initial vision and vaguely described demands of the client also cause problems for the engineer. Sometimes it is difficult to really understand what the client demands and what are his or her priorities. This is also different depending on the person representing the client. The changes in requirements and demands during the project affect engineers' work significantly, but this effect is not always understood by the clients. Another reason for late changes of the concept is more detailed geological information, which arrives overdue during the conceptual design process or at even later stages.

Finally, most of the interviewed specialists agreed that conceptual design can be improved and that experience from previous projects needs to be organised better and reused more efficiently, Dekker (2000).

¹ VR – Virtual Reality

2.5 Practical lessons learned from the ‘Virserum’ timber bridge

During the spring of 2010, the author participated in a timber bridge engineering competition, which was organised as a joint-work with master’s students from both Architecture and Engineering and Civil Engineering at Chalmers University of Technology (Figure 2.15). A part of the task was to design a timber bridge for the ‘Virserum’ wood exhibition, which was to be held in the summer of 2010 in the village of Virserum, Sweden. This event takes place every three years and attracts thousands of visitors from Sweden and other countries.



Figure 2.15 Discussion on the concept

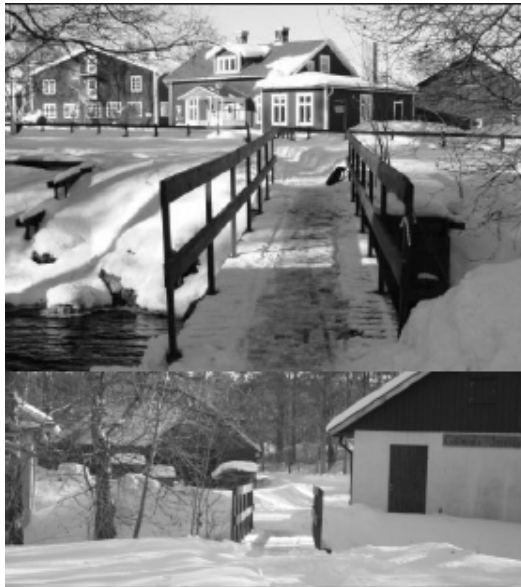

Figure 2.16 The site

The focus of this section is on the ‘real world’ experience during conceptual and preliminary design and construction of the 9 m spanning ‘Virserum bridge’ and not on the competition itself. More detailed information about the whole competition can be found in Tosi (2010). Because of the fact that the team consisted of 10-12 students – both structural engineering and architectural students – the dialog started from the very beginning.

The work started with defining the needs and requirements of the client. Below is a short summary of them and into which area each demand falls:

- Good aesthetics and appearance should be strived for as this is an international exhibition on wooden and timber products - ***Architectural***
- The solution must be as cheap as possible since the client (exhibition organiser) financed the project himself - ***Economical***
- The whole construction process should be finished within 3 days by the students themselves (Figure 2.18) - ***Production***
- The bridge should be made primarily of timber, while using only screws, nails and few bolts and metal connectors - ***Production***
- The bridge's weight must not exceed 600-700 kg since this was the capacity of the crane - ***Production***
- In addition, during the design phase there was a constant inflow of new information and need of changes from the client due to different reasons – ***Technical/Production***
- It was decided to place the bridge next to the existing one (Figure 2.16) - ***Production***

To start with, the work began with developing concepts and visions for the new bridge. Collaboration and dialog during that process were significant and each aspect was criticised thoroughly from structural as well as aesthetical points of view. During the conceptual design, three different concepts were established and evaluated (Figure 2.17). However, no guidance or tools were used; on the contrary, everything depended on architectural feeling and previous experience. At this stage it was the architects challenging their creativity rather than thinking more practically. It became evident that the more simple and proven solution engineers argued for, the more uninspiring and boring it looked. The conclusion is simple: as everything in nature, a balance has to be achieved. It can be achieved with a holistic view and understanding of structural art and its consequences on the society and environment. Due to the nature of this project, conceptual design was a longer process as it was not a mainstream solution and had to be built by the students during three days. Being a pedestrian bridge it gave a lot of freedom to experiment with shapes and design.

The final decision on, which concept to continue with was made after a critique session from practising architects and the choice of the client. The chosen concept was the 'V bridge' mainly because of its practicality and feasibility of construction compared to the other possibilities.



Figure 2.17 The three proposals established during conceptual design phase



Figure 2.18 During construction

Consequently, the construction begun and immediately various issues emerged. The initial choice of 4 main glulam beams had to be dramatically changed – due to a delay in delivery, the team had to rethink and redesign the main load-carrying system. This shows the need for margins of flexibility that have to be included in the design, since in almost every project there are deviations from the original design. The main strategy in those situations is to improvise and try to stick to the main idea behind the concept chosen. The obstacle for this bridge was a small river and the bridge's robustness and rigidity of connections were crucial. Although some calculations for the main joints were done, the engineers' 'feeling' and rules of thumbs were used. Even though it was not the most efficient way, it provided the needed safety.

Some important aspects were recognised in the late stages of the building process (see Figure 2.18). Due to the eccentric cross-section (Figure 2.19) and loading, the bridge was designed to work in torsion and was fixed at both ends by anchoring bolts. Since the structure was already placed and anchored, one big weakness was discovered – the bridge's torsional stiffness was not sufficient even though the bridge had diagonals between the lower flanges and was a trussed box. Bracing was added in the upper flange and the problem resolved successfully. The lesson learned is that if more thorough study had been carried out in the preliminary stage, this unforeseen problem can have been avoided. This perfectly reflects the relationship later change - bigger cost. In this case the cost was the extra time resource spent.

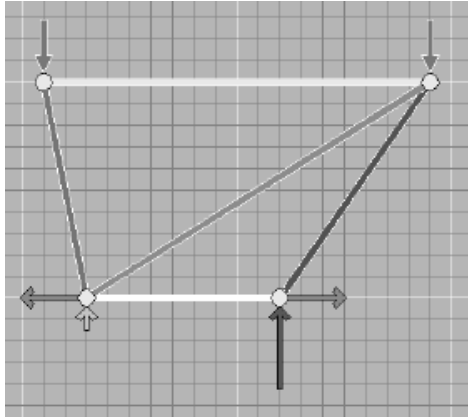

Figure 2.19 Cross-section with load distribution

Conclusions:

- The collaborative work between architects and engineers gave a great balance between aesthetical impact and structural robustness
- Developing concepts only by architects was probably not the best way since they do not always have a deep understanding of how bridges work structurally
- Flexibility in the design is important, as it allows for unforeseen changes during later stages
- Designing and constructing a bridge even for a temporary use proved to be a very challenging and exciting task both for engineers and architects
- Production demands turned out to be the most influencing on the concept
- While the load-carrying system is well-known, the details (carpentry, flexible railings and visual effects) and the specific unsymmetrical shape gave the bridge a unique presence (Figure 2.20).



Figure 2.20 The completed bridge

2.6 Conditions and constraints affecting bridge design in Bulgaria, Pakistan and worldwide

Engineering and bridge design vary from country to country due to various factors such as traditions, economical and political situations or local geographical conditions.

The main aim of bridges is to transport traffic of people and goods – road, railway, pedestrian or other. To accomplish this task, bridges must be able to withstand the loads imposed by this traffic and every other action like wind, snow, frost, seismic etc. Dynamic loads from earthquakes in particular play a very significant role in design of structures in areas where seismic action is common and has substantial levels. The above mentioned facts affect the conceptual design of bridges as well. For example, in order to accommodate for big accelerations and movements, simply supported bridges are preferred so that these imposed displacements can be taken without excessive restraint stresses. Moreover, ductile materials such as steel are preferred as they allow for plastification and can resist the action with larger displacements without collapsing in case of a high magnitude earthquake. This is completely opposite to the practice in Sweden (which lies in non-seismic area), where concrete frame bridges are extremely common solutions. A single pier middle support (Figure 2.21) is a very inappropriate solution in seismic areas as it is not effective to resist the big dynamic forces only by bending stiffness of the column. This shows another difference between solutions in seismic areas and the Swedish practice where one column (pier) is a quite common solution.

Another example is areas with strong winds – tornados, hurricanes and so on. The engineer will most probably opt for heavier bridge structures to prevent them from being displaced by the extreme wind pressures. Choosing a light timber bridge might be good if it is a standardised cheap solution in a similar fashion like residential houses in tornado areas in USA – already in the concept it is decided to build a timber house and rebuild it after the disaster rather than going for an expensive solution, which is designed to resist the forces of the nature. These two examples show how significantly conceptual design can be affected by local geographical conditions.

Economical and political situations affect bridge design as well. If a country is suffering from economical crisis, it cannot afford to experiment with innovative bridge designs or new construction methods. In addition, political system also shapes the construction industry. In the Soviet block most of the research was done into optimisation and unification of structures and the result was a lot of traditions and experience in prefabricated prestressed concrete beam bridges. This, combined with seismic action, has led to the fact that the majority of highway bridges in Bulgaria are prefabricated concrete beams.

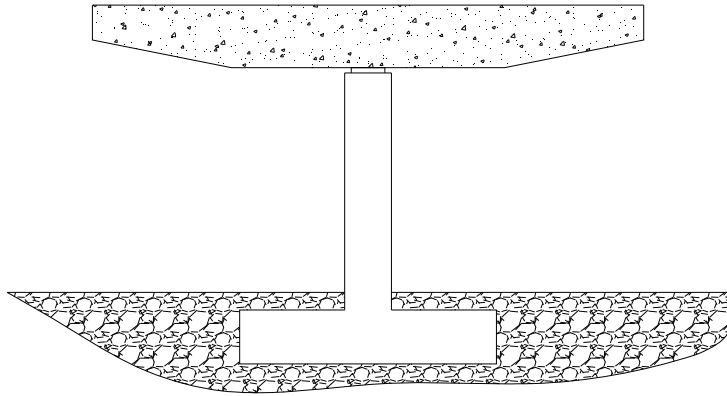

Figure 2.21 Single pier

Types of Bridges Used in Pakistan

In Pakistan many types of bridges have been constructed ranging from slab bridges to truss bridges spanning more than 60 meters. Similarly to the rest of the world, the selection of a certain bridge type is greatly influenced by the type of loading and site conditions. Many other factors like political influence, aesthetics or importance on the basis of defence, play important roles in bridge design. Sometimes bridges are designed for military loading if they are located in areas under military jurisdiction.

If we try to generalise the bridges according to the type of traffic they carry, then road, railway and pedestrian bridges are usually found in Pakistan. In road bridges, concrete is the most preferable material because steel and timber are expensive in Pakistan as compared to the rest of world. Reinforced concrete slab bridges, reinforced concrete beam-slab bridges and prestressed concrete bridges are found, usually with a span range up to 30 meters. The substructure's design is greatly affected by the subsurface conditions and elevation. Piles with transom¹ have been a common solution of the substructure during the past decade. For railways, Pakistan Railways usually applies one of the following structural systems: reinforced concrete slab, steel I-girders with concrete deck, steel trusses and prestressed box girders. In case of pedestrian bridges concrete and steel structures are still the most common option. Unlike Sweden, where wood is cheaper and with better quality, timber pedestrian bridges are not common in Pakistan.

Some bridges are designed keeping in mind some special circumstances. For example the Colander Hamilton Bridge² type is used for temporary solutions in case of emergent bridge replacement and for construction by military engineering units. Under current bridge design practice, conceptual design is highly influenced by the fact that Pakistan is situated in an earthquake zone along with flood hazard. Of this

¹ 'transom' are deep beams which rest on composite piles and transfer the load from the superstructure to the piles

² The Colander-Hamilton Bridge is a modular portable pre-fabricated steel truss bridge.

reason concrete frame bridges are not a common solution for short-spans in Pakistan, unlike Sweden.

2.7 Summary

Conceptual design is the most creative part of bridge engineering, but at the same time probably the most demanding. It requires experience and broad knowledge of all areas connected with bridges – from legal aspects, to technical details and ability to extract and understand the needs of the client. Most often the problem is open and it is the designer's responsibility to find the most appropriate solution. Even though conceptual design is known for centuries, there is still a lack of helpful guidelines and methodologies to support the designer. That is why it is very common that the engineer chooses very well-known solutions even without considering other options. The reason for this is mainly shortage of time. However, investing more time in conceptual design will always lead to a more optimal final product.

3 Classification of the most typical design situations

This chapter classifies the most commonly met design situations when it comes to design of short-span bridges. First a more general classification is made and then the most important factors are selected. Although every bridge is unique and every situation has its specific conditions, this classification provides a good overview and tries to divide the complex problem into simpler ones.

3.1 Methodology and approach

First of all, it is important to think about the needs and demands the society has concerning a new bridge. Moreover, the specific site conditions or constraints play important roles in developing a concept. It is very easy to make the mistake of thinking not on a concept but on a specific solution (for example a concrete frame bridge) straight away. This immediately narrows and restricts engineers view. It is very crucial to differentiate between the ‘demand’ and the solution. For example, the **demand is to cross** the river, but it can be fulfilled by a bridge, a tunnel or a ferry (possible solutions).

Secondly, conceptual design includes much broader perspective and is not only limited to the bridge itself. Usually it is a whole stretch of road that needs to be designed and the bridge engineer must work in close collaboration with the landscape architects, road planners and so on. In Swedish practice the most common situation for bridges is that a corridor (see the shaded area in Figure 3.1), where the new road can be placed, is given by the client. This means that the exact place of the bridge is often not clearly defined and it is the task of the conceptual engineer to take into account all the considerations, not only his specific input about the bridge itself. Due to the fact that every situation is unique and the problem includes infinite variables, this classification focuses mostly on cases when the place of the bridge is decided.

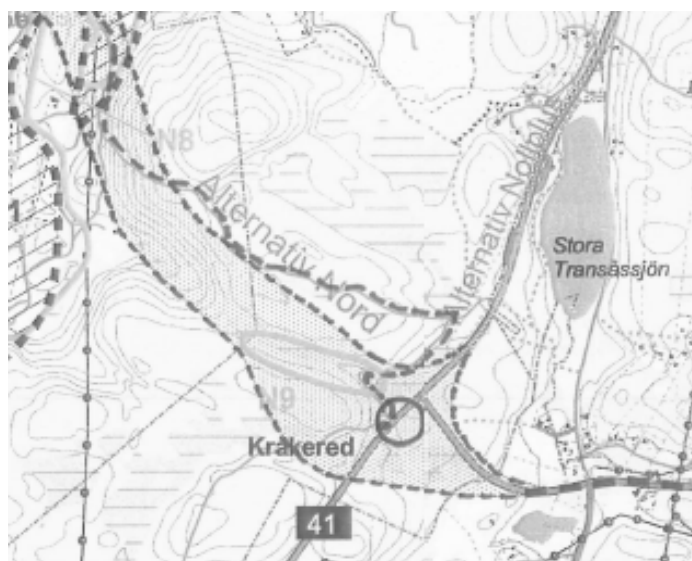

Figure 3.1 Typical corridor (Ramböll)

3.2 Classification of demands, constraints and conditions

After the literature studies and talks with specialists, the most decisive types of constraints, conditions or demands were found out. They were selected by their importance and although it is not always easy to separate them from each other, the classification of parameters is fairly logical (random order):

- Type of traffic to transport
- Ground conditions
- Length of the bridge
- Type of obstacle to cross
- Relation between centre lines of the bridge and the obstacle
- Location (position in the environment)

Type of traffic is probably the most important factor for the classification of bridges because design loads, clearances and specific requirements depend on it. **Ground conditions** affect both the choice of substructure and superstructure. The geotechnical situation is the most unknown and unclear of all conditions and requires special attention. Often a redesign is needed when some more detailed information has been discovered. The type of soil affects the choice of material and type of foundation system. The scope of this research work is limited to short-span bridges, which are further classified into three different categories by their **length**. This refinement is needed mainly to increase the precision of the method. The classification of length is slightly questionable as it concerns both the demand and the solution. For example, the height of the profile of the road defines the length of the bridge. However it is quite a logical classification. Another important parameter is the **type of obstacle** for the bridge to cross and the site plan. Conditions on site can dictate the possibility of placement of middle support. Any physical restriction has to be considered in the geometric design. Other important parameter is the **relation between the centreline of the future bridge and the obstacle's**. That relation can lead to need of a skewed or curved bridge, which is more complicated and expensive. Finally, **location** is considered: is the bridge located in a congested urban area or outside in the countryside for example? This affects the aesthetical decisions and consultation with architects and landscape architects is needed.

All the above mentioned parameters important for classification of the design situation together with their most common sub-options are systematised in Table 3.1.

Table 3.1 Specification of demands, constraints and conditions

A	B	C	D	E	F _(optional)
Type of traffic	Type of obstacle to bridge	Length	Ground conditions	Location	Bridge vs obstacle
1. Road	1. Water- River	1. < 8 m	1. Clay (or cohes. soil)	1. Urban	1. \perp
2. Ped.and bicycle	2. Water- stream, spring	2. 8-18 m	2. Rock	2. Highway	2. skewed
3. Railway	3. Road	3. 18-30 m	3. Frictional material	3. Countryside	3. curved
4. Fauna (animals)	4. Railway track				
	5. Pedestrian passage				
	6. Fauna passage				

Note that combinations of parameters in one column (Table 3.1) are possible and usually present. For example very often a road bridge has a pedestrian walkway or the obstacle is an existing road and a pedestrian pass. Another example can be different soil conditions at both ends of the bridge or the inability to define whether the location is urban or countryside (for example outskirts of a town). For simplicity, all these combination and nuances are not reflected. Instead, the focus is on the main type (biggest importance) of parameter for each column, which will govern the final solution.

3.3 Refining of design situations and classification

Theoretically there are 1944 possible combinations of the different parameters in Table 3.1, where each combination would represent one type of design situation. Even that many, they can still not fully cover all the various situations a bridge engineer faces in reality. However, the aim of this project was to identify the most commonly met cases, so the authors needed to further simplify the specification of parameters and based their choice on the information collected beforehand. Table 3.2 shows a simplified specification of parameters.

Table 3.2 Simplified specification of demands, constraints and conditions

Primary			Secondary		
A	B	C	D	E	F _(optional)
Type of traffic	Type of obstacle to bridge	Ground conditions	Length	Location	Bridge vs obstacle
1. Road and/or fauna	1. Water	1. Clay (or cohes. soil)	1. < 8 m	1. Urban	1. \perp
2. Ped.and bicycle	2. Road and/or railway	2. Rock	2. 8-18 m	2. Highway	2. skewed
3. Railway	3. Fauna or ped. passage	3. Frictional material	3. 18-30 m	3. Countryside	3. curved
	4. Fauna and water				

Road traffic and fauna (landscape) bridges have certain similarities. As the ground fill for fauna bridges is present, the dead load is quite similar to that of a road track











surface. Moreover, the client always wants a versatile structure used for as many purposes as possible. This leads to fauna bridges with a road lane (see Figure 3.2). The latter justifies the combination of both types of traffic. However, a recent trend is designing bridges only for environmental purposes and we can expect an increase of these cases in the near future.



Figure 3.2 Fauna bridge with road lane over E6 near Uddevalla, courtesy of Google maps (2011).

In Table 3.2, column B (type of obstacle), two other simplifications are made. Firstly, all water obstacles are united. The reason behind this is that both represent a similar demand to avoid working in water due to the difficulties and restrictions this would impose. Moreover, water levels vary throughout the year and a small creek can emerge into a small river during the spring season. Unification between road and railway obstacles is done as well. Apart from some details (fences on the bridge over the railway line), the biggest difference between them is the free height required – 4.70 m for traffic and 5.9-6.5 m for railway, Vägverket (1996). As it can be seen in Table 3.2, the three primary parameters are type of main traffic, which goes on the bridge, the type of obstacle the bridge crosses and the ground conditions. The secondary parameters like length, location and angle alter the resulting solution, but not that significantly as the primary ones. Length is considered secondary because it is the engineer's choice to decide how long the bridges will be – should it cover the gap of obstacle exactly or be longer, allowing for more open view and other advantages. Of course here we still think of bridges with a length less than 30 m according to the scope of the project. Furthermore, a decision to remove the distinction to three length intervals was made since this would bring more confusion than benefits. Both the location and the relation between bridge and obstacle contribute more to the architectural and structural demands. The primary parameters needed for classification of design situations of bridges are summarized in Table 3.3.





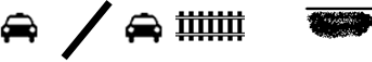









Table 3.3 Primary parameters for classification of the design situation

Primary parameters		
A	B	C
Type of traffic	Type of obstacle to bridge	Ground conditions
1. Road and/or fauna 	1. Water 	1. Clay (or cohesive soil) 
2. Pedestrian and cycle 	2. Road and/or railway 	2. Rock 
3. Railway traffic 	3. Pedestrian passage 	3. Frictional material 
	4. Fauna and water 	

The theoretical number of combinations is now only 36, which represents 36 different design situations. The selection of the most common design cases is based on the primary parameters. The ground conditions, as mentioned before, are very significant and an uncertain parameter. However, it was discovered that for short-span bridges they affect mostly the choice of the substructure and not too much the superstructure. Moreover, if the soil is not very good (silt or clay), it is common to remove it and replace it with frictional material whenever possible and cost effective. The only case where ground conditions have a big effect is for bridges with inclined supports or arched bridges. The big horizontal forces are very difficult to accommodate when clay is present and sometimes even for frictional material. Another aspect is that a very large amount of the cost is related to the foundation and the width of the foundation slabs.

The final classification of design situations is presented in Table 3.4.

Table 3.4 Demand cases (design situations)

Case	Description	Visualisation
1	Road bridge over railway or road	
2	Road bridge over pedestrian passage	
3	Road bridge over water	
4	Railway bridge over water	
5	Railway bridge over Road	
6	Road bridge over railway or road	
7	Road bridge over pedestrian passage	
8	Railway bridge over water	
9	Road bridge over railway or road	
10	Road bridge over pedestrian passage	
11	Road bridge over water	
12	Road bridge over water+fauna	
13	Road bridge over water+fauna	
		Frictional material 
		Clay (or cohes. soil) 
		Rock 

4 Different solutions for short-span bridges

This chapter presents most of the possible solutions for short-span bridges, except some special cases such as movable, aircraft, and military bridges and other specific cases. It includes both common and well-known solutions and some examples of new trends that can be found worldwide. The aim is to broaden the engineer's view so that he or she considers more options. Limitations of the selected solutions are the maximum length of 30 m and that the focus is mostly on the type of superstructure. For simplicity a classification of the solutions is made, mainly by their main material for the longitudinal load-bearing system as follows:

- Concrete bridges
- Steel bridges
- Timber bridges
- Composite bridges

4.1 Concrete bridges

Nowadays concrete bridges represent almost 90% of the bridges built in Sweden. Similarly, in the rest of the world concrete is as well preferred material in bridge construction especially for shorter spans. The main advantages are lower cost, better durability and good traditions in use of this material. The biggest drawbacks are the higher self-weight, longer construction time, larger labour usage and probably aesthetical deteriorations after some time. Concrete bridges can also be unpleasant aesthetically because of more a massive outlook and higher construction heights. Colouring and texture also play role in this appearance and solutions already exist to enhance these properties of bridges. In fact, attention to details and texture can transform concrete bridges to very attractive landmarks. One maintenance demand, similar for all concrete solutions in Sweden, is the need of replacement of edge beams, which most often must be done two times during the life (80 years) of a bridge.

4.1.1 Slab-frame cast in-situ



Figure 4.1 Typical slab-frame concrete bridge, from Vägverket (2006)

Description: The slab-frame bridge is the most common type of bridge in Sweden (almost 50% of the bridges belonging to the Road Administration (Vägverket) are of this type). It is a very simple and cheap solution for short spans and when crossing narrower obstacles (roads, pedestrian passes and etc.). It is very effective, since in this type the sub- and superstructures are united thus acting together. This solution relies on frame action and the bridge takes earth pressure and imposed loads at the same time (Figure 4.1). There is no need of bearings and expansion joints, which leads to lower maintenance work. For lengths up to 10 m, usually a full box is designed (a frame with integrated bottom slab), which gives high rigidity and superior load distribution to the soil. This quality makes it a good alternative in case of soils with low bearing capacity. Due to the overall rigidity of this concept, there is a possibility to cast the bridge beside its future location and slide it in place when ready. Examples of cross-sections are shown in Figure 4.4.

Optimal span: 4-20 m, above 22 m prestressing is advised (economically competitive).

Span-to-depth ratios: depends on the height of the side walls (Figure 4.2, 4.3).

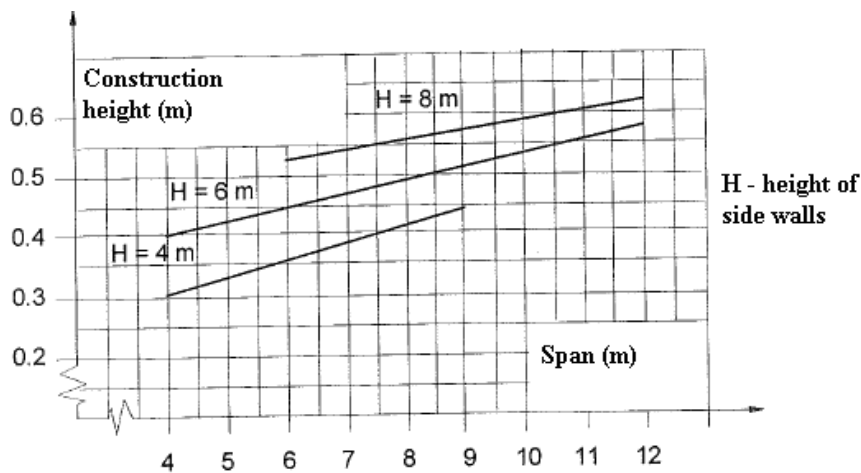

Figure 4.2 For spans 4-12 m, from Vägverket (1996)

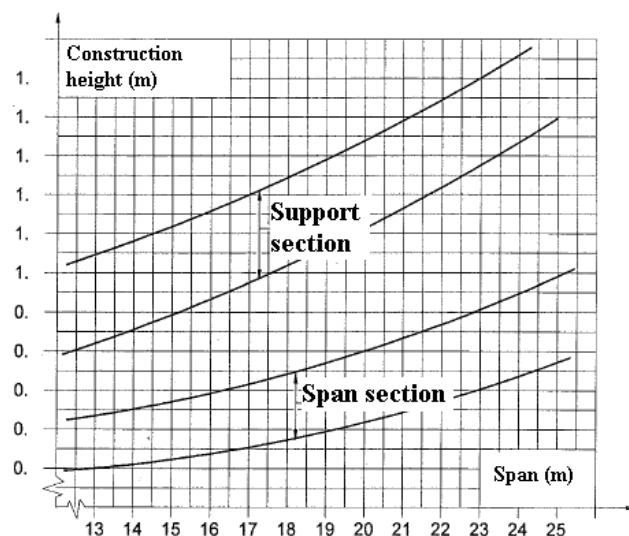

Figure 4.3 For spans 12-25 m, from Vägverket (1996)

Advantages: This bridge type is possibly the cheapest alternative (especially for shorter spans); economically advantageous for short spans and good ground conditions, Vägverket (1996); low construction height; very long traditions; robustness; cheap and simple formwork and construction; flexibility in shape and design.

Drawbacks: A restriction is needed in angle of skew since it introduces big torsional moments, which increases ground stresses; not recyclable.

More information: Vägverket (1996)

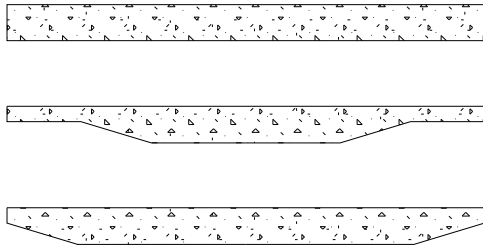

Figure 4.4 Examples of cross-section configurations

4.1.2 Beam-frame cast in-situ



Figure 4.5 The beams are fixed into the abutments, from Vägverket (1996)

Description: This bridge type is very similar to the slab-frame bridge described in Section 4.1.1, but suitable for longer spans and wider bridges. Again it relies on frame action, but here the bridge deck is ribbed (Figure 4.5). There is no need of bearings and expansion joints, which leads to lower maintenance w. However, most often prestressing is used and this increases the price. Very rarely it is designed as a multi-span bridge. The same recommendations as in Figures 4.2 and 4.3 apply.

Advantages: This bridge can easily achieve longer spans; robustness; mechanically efficient shape; flexibility in shape and design.

Drawbacks: It is not very cost efficient in the span range below 30 m; not recyclable; higher construction height compared to the slab-frame alternative; more expensive than the slab-frame bridge due to complex formwork and prestressing (if present).

Optimal span: 24-40 m; economically competitive >20 m

Span-to-depth ratios: n.a.

More info: Vägverket (1996)

4.1.3 Integral abutments (jointless bridges)

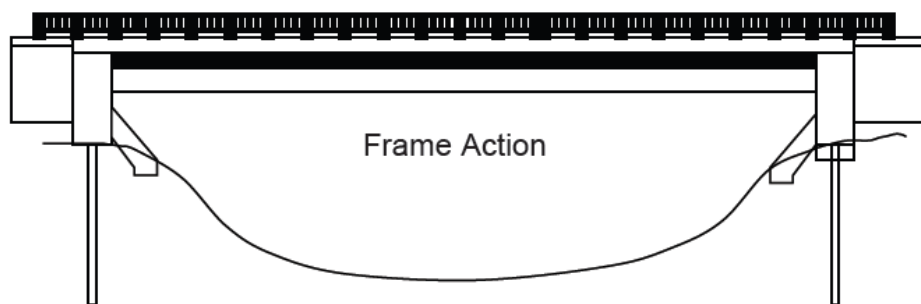

Figure 4.6 Principal scheme from Allen, C. et al. (2008)

Description: This methodology of constructing bridges is a rather new approach and has been used in Sweden only for a pilot project. However, in Northern America it is already a common solution. The main idea is to avoid the cost of bearings and movement joints between the sub- and superstructures (Figure 4.6). The deck structure can be of concrete or steel, but concrete is mostly preferred (timber is not effective). Here this bridge type is put under the heading concrete bridges as concrete solutions are most common in this system.

According to Allen, C. et al. (2008):

'The primary difference between an integral abutment bridge and a conventional bridge is the manner in, which movement is accommodated. A conventional bridge accommodates movement by means of sliding bearing surfaces. An integral abutment bridge accommodates movement by designing each abutment to move unrestricted as a result of longitudinal loading effects with less induced stress, thus permitting the use of lighter and smaller abutments.'

A conventional elastic analysis cannot represent how the loads are resisted. Integral abutments are suitable for single spans no longer than 44 m using a 'Simplified design method', Allen, C. et al. (2008). This design approach is not in line with Swedish standards, but can be guiding.

Advantages: This bridge type has reduced initial and lifecycle costs, due to jointless construction; lighter and smaller abutments; shorter time for foundation construction compared to traditional piling; can be used for single and multiple span bridges; can resist uplifting forces; higher redundancy; no tolerance problems (as no joints and bearings exist).

Drawbacks: More complicated design and lack of knowledge in the area; piling is always needed, but only one row is enough. On the contrary, when using the standard approach for abutments, more than one row is needed; optimal up to 30° inclination.

Optimal span: 16-30 m (acc. to the authors)

Span-to-depth ratios: n.a

More info: Reference pilot project in Sweden – over the river Fjällå outside Dorotea.

Allen, C. et al. (2008); Vasant (2000); Asphage, Cl. (2009)

4.1.4 Simply supported slab cast in-situ with end walls

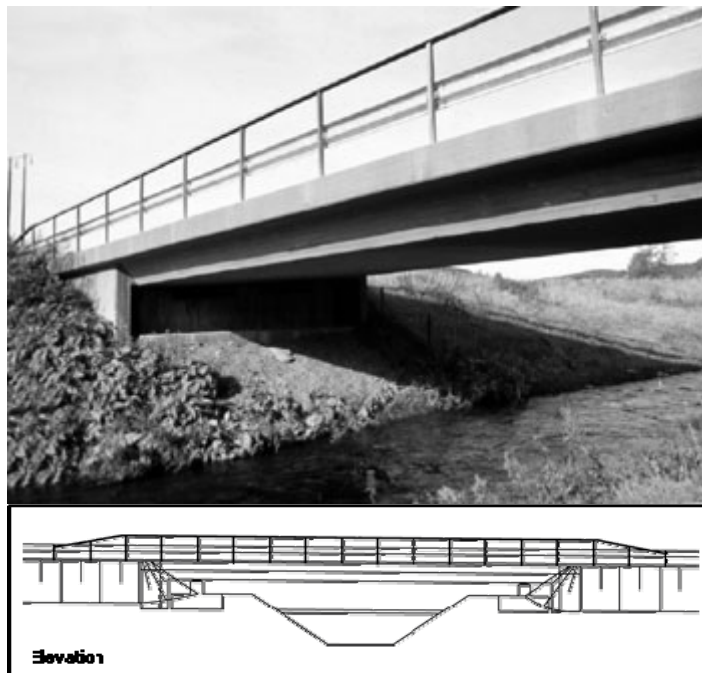

Figure 4.7 Typical slab solution, from BaTMan (2011)

Description: This type relies on slab action and is simply supported at the ends (Figure 4.7). Usually it is made with constant slab depth, which makes it easier for the formwork and reinforcement placing. For example, prefabricated 'rolled' reinforcement mentioned in Section 2.2.3 is a new fast way of achieving that. At both ends there are small vertical walls cast together with the deck. The walls cope with the earth pressure from the soil. The cross-section of the slab can have different shapes in order to optimise the design and reduce the deadweight. For spans over 20 m and up to 35 m, prestressing is advised. The end walls give one very good advantage – difficult and expensive foundation works in water can be avoided.

Advantages: Lower construction height compared to beam cast in-situ (Section 4.1.6); cheap and simple formwork and construction; possibility to lift the level of the foundation slab, i.e. avoiding working in water; flexibility in shape and design.

Drawbacks: low recyclability;

Optimal span: 8-22 m for single span, 25 m in case of two spans.

Span-to-depth ratios: 22-25 for single spans.

More info: Vägverket (1996), *fib* (2000).

4.1.5 Simply supported beam cast in-situ



Figure 4.8 Beam bridge, box cross-section, from Ehlorsson, V.; Palmqvist, V. (2010)

Description: This bridge type is very similar to the slab solution presented in Section 4.1.4, but here the cross-section is a T-section, where the slab forms the flange (Figure 4.8). The beam is supported on bearings and this solution is suitable for longer spans compared to the slab. For spans between 20-30 m prestressing is competitive and it is the construction height that is decisive. However, it is advisable to use prestressing with spans greater than 25 m as the self-weight becomes very heavy.

Advantages: Traditional solution; flexibility in shape and design; cheap and simple formwork and construction.

Drawbacks: Higher construction height; not recyclable; less pleasant aesthetically.

Optimal span: >24 m.

Span-to-depth ratios: (10-14) for reinforced concrete; (14-25) for prestressed concrete.

More info: Vägverket (1996)

4.1.6 Through concrete beam cast in-situ – flat type

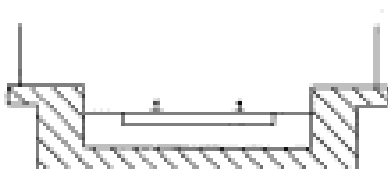

Figure 4.9 Through beam bridge, flat, from Vägverket (1996)

Description: This solution (Figure 4.9) is only used for railway traffic. The concept is similar to bridge type presented in Section 4.1.5, but the shape is specific to accommodate the rails. For spans above 20 m prestressing is advised.

Advantages: Better looking aesthetically compared to the ‘ribbed’ through bridge from Section 4.1.7. Traditional solution; cheaper than steel solutions for railway traffic,

Drawbacks: Not recyclable.

Optimal span: 10-20 m.

Span-to-depth ratios: n.a.

More info: Vägverket (1996)

4.1.7 Through concrete beam cast in-situ – ribbed type

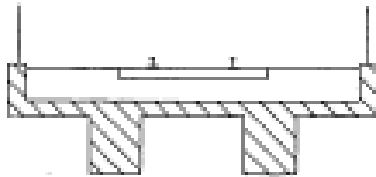

Figure 4.10 Through beam bridge, ribbed, from Vägverket (1996)

Description: This solution is only used for railway traffic. The concept is exactly the same as the one in Section 4.1.6, but only the shape is different (Figure 4.10). For spans above 20 m prestressing is advised.

Advantages: Traditional solution; cheaper than steel solutions for railway traffic.

Drawbacks: Not recyclable; higher construction height than the ‘flat’ through bridge but needs less width.

Optimal span: 10-20 m.

Span-to-depth ratios: n.a.

More info: Vägverket (1996)

4.1.8 Prefabricated prestressed hollow core elements

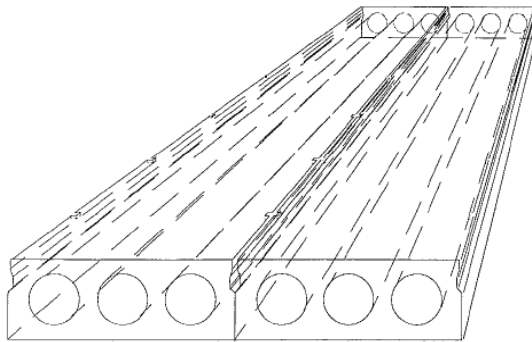

Figure 4.11 Hollow core elements, from Vägverket (1996)

Description: The hollow core elements are prefabricated in a factory where they are prestressed by pre-tensioning. The cross-section can have different layouts and sizes depending on the manufacturer. They are almost always used for simply supported single spans (Figure 4.11) and longer bridge can be achieved by many successive spans. However, for the scope of the thesis, only single span solutions are considered here. This option is not a very common solution in Swedish practice, due to mainly bad experience with these products (maintenance problems), although they are high quality products requiring less formwork and little need for site storage. However, care and protection is required during storage, transport and handling resulting in extra costs. Attention is needed for connections and tolerances.

Advantages: Simplicity and quality; short erection time compared to cast in-situ solutions; efficient use of material; the element carries the load and is a bridge deck at the same time.

Drawbacks: Limited number of options for the cross-section; prestressing steel is very sensitive to corrosion; possible vibration problems (inappropriate serviceability); cannot be curved; attention is needed for connections and tolerances; late alterations are impossible; increased maintenance costs if bad geotechnical conditions are present.

Optimal span: Up to 10 m for road traffic, Hollow core concrete (2011)

Span-to-depth ratios: n.a.

More info: Vägverket (1996)

4.1.9 Prefabricated prestressed beam elements

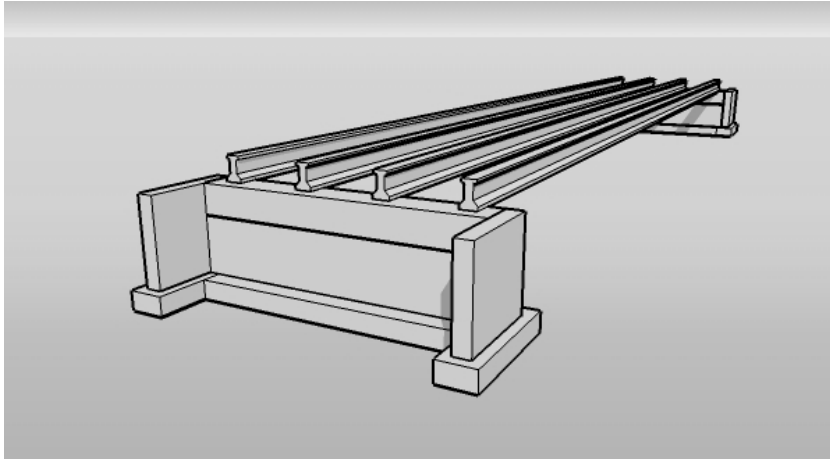

Figure 4.12 Prefabricated I-girder solutions (from www.tallbridgeguy.com)

Description: The girders are prefabricated in a factory and prestressed by pre-tensioning there. The cross-section can have different layouts and sizes depending on the manufacturer. The bridge girders are usually used for simply supported single spans (Figure 4.12), but can shape a longer bridge consisting of many single spans. However, for the scope of the thesis, only single span solutions are considered. After placement of the girders on the abutments, a formwork is placed on top of the beams and a concrete deck is cast in-situ. Prefabricated concrete beams are very rarely used in Sweden, mainly due to lapse of tradition. On the other hand, in countries like USA, Canada and in Western Europe they are used significantly, sometimes comprising up to 50% of the built bridges.

Advantages: Simplicity and quality; short erection time as compared to cast in-situ solutions; efficient use of material.

Drawbacks: A fixed and limited number of options for the cross-section; prestressing steel is very sensitive to corrosion; slower construction compared to hollow core bridges, because of the need of a cast in-situ deck; only a small horizontal curve can be achieved by the deck, as the beams are straight; attention is needed for tolerances; late alterations are impossible; care and protection is required during storage, transport and handling resulting in extra costs; increased maintenance costs if bad geotechnical conditions are present.

Optimal span: 15-30 m.

Span-to-depth ratios:

More info: Vägverket (1996)

4.1.10 Prefabricated pedestrian and bicycle tunnel

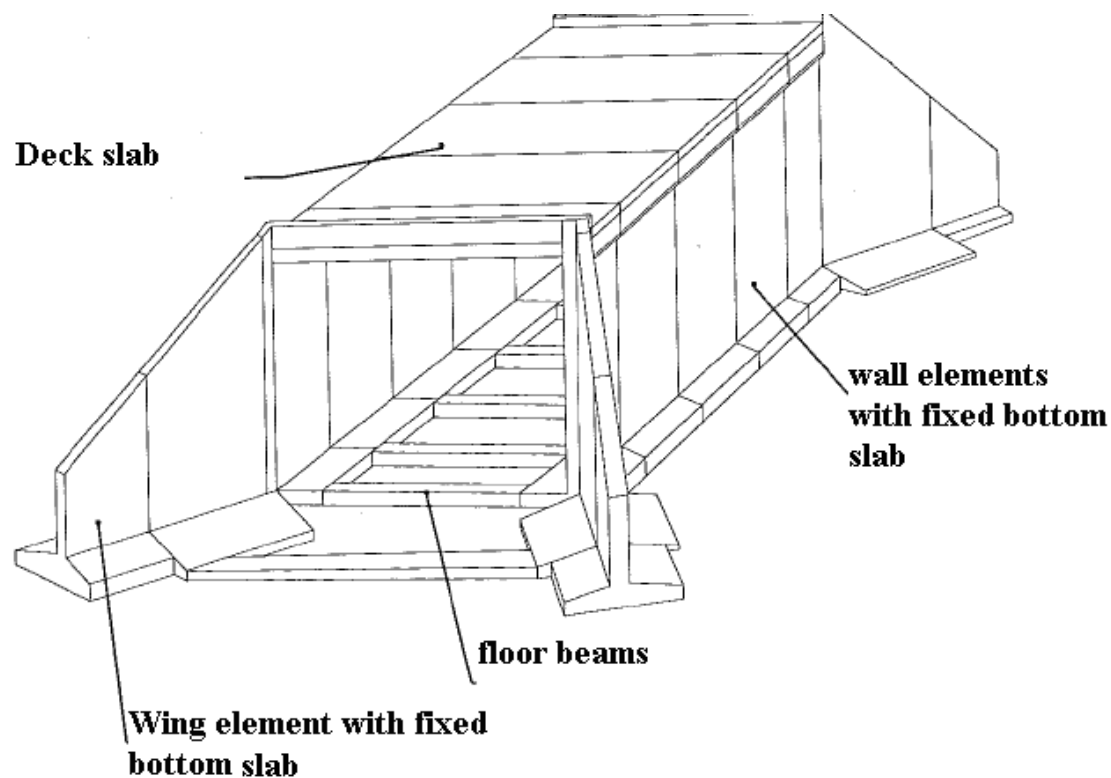

Figure 4.13 Typical prefabricated tunnel, from Vägverket (1996)

Description: Even though this solution is labelled a tunnel, it is actually a bridge for the road traffic on it. All the elements are prefabricated and assembled at the site (Figure 4.13). This bridge can also be used when a skew solution is needed. It is a very promising alternative and is gaining popularity in Sweden.

Advantages: Very fast and precise assembly, good quality of the concrete surface and details.

Drawbacks: Requires dry ground before placing; little flexibility in design; aesthetically inferior; limited span lengths; increased maintenance costs if bad geotechnical conditions are present. If bad geotechnical conditions are present, increased maintenance costs can be expected.

Optimal span: 2-10 m.

Span-to-depth ratios:

More info: Vägverket (1996); Matiere (2011); Abetong (2011)

4.2 Steel bridges

Steel as material is considered not very competitive for short spans, mainly because of its cost. However, for lengths above 40 m it competes with concrete successfully. For short-span bridges, steel (except composite solutions with concrete deck) is almost

exquisitely used for railway and pedestrian bridges. The biggest advantages of steel solutions are lightweight, very fast erection and precision of the products. Furthermore, steel bridges behave very well under dynamic and seismic loading. Disadvantages include higher initial cost, possible corrosion and fatigue problems during the service life.

Due to the fact that the scope of the thesis project is limited to bridges with a length up to 30 m, only one type of steel bridge is presented. One reason is that it is not a common practice to use pure steel bridges in Sweden and secondly in most of the cases with steel, the solution is composite bridges with steel girders and a concrete deck (see Section 4.4). In the past a lot of railway bridges were made only out of steel, most often trusses.

4.2.1 Corrugated steel tube

Description: This bridge type is a very simple and cheap solution for road and railway bridges over a small creek or fauna passage (Figure 4.14). It mostly relies on arch action from the soil in combination with a corrugated steel sheet that provides the shape. These bridges can be produced in different shape configurations (Figure 4.15) and can be arranged at a skew angle. This option is almost always used when a fauna bridge with less than 9 meters span is needed.



Figure 4.14 A typical solution over a creek, from Vägverket (1996)

Advantages: Cheap and simple; easy to remove or strengthen; very suitable for fauna and pedestrian passages.

Drawbacks: It needs a minimum overburden height; considered to be dull and not visually appealing.

Optimal span: 2-7m.

Span-to-depth ratios: irrelevant.

More information: Vägverket (1996)

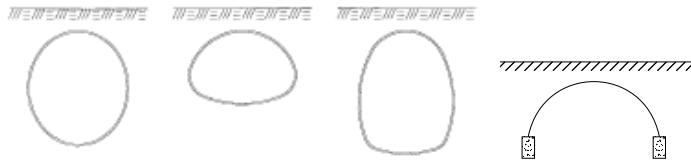

Figure 4.15 Different shapes and configurations of corrugated steel bridges, from Vägverket (1996)

4.3 Timber bridges

Timber bridges have good tradition in Sweden, especially for pedestrian purposes. General advantages of timber bridges are lower weight to load-bearing capacity ratio, excellent sustainability, aesthetical features and also fast erection. On the other hand, disadvantages include shorter service life, durability problems and the complex nature of wood and timber. In addition to this, timber bridges are more expensive than corresponding concrete bridges when longer single spans are needed. 'Martinsons', a leading Swedish timber products manufacturer, provides the following chart (Figure 4.16) for spans ranges and different purposes ¹(translation provided in the footnote).

Advantages of timber bridges are that they do not require heavy machinery or specially trained labour to be built. Moreover, they are erected in a very short time – sometimes for a couple of hours. Almost all of the timber used for the main load-bearing structure is glulam².

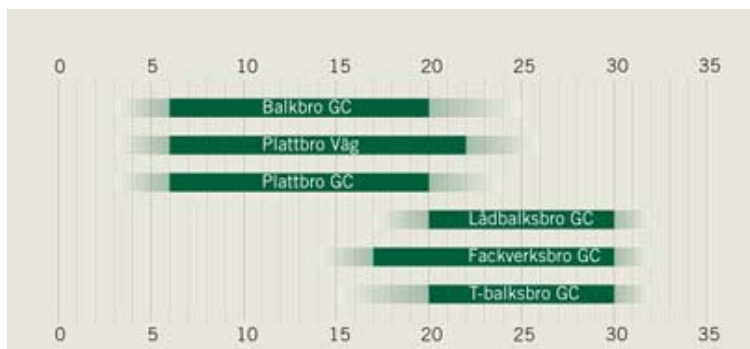

Figure 4.16 Span chart for timber solutions, Martinsons (2011)

Although Swedish timber industry has long traditions, timber bridges represent a small portion of the bridges built in the country. Even though durability of timber structures has improved significantly during the years, the biggest disadvantage of timber bridges is still the difficulty to assure durability during the life span, due to different deterioration processes. One solution is the 'Creosote' protection, which is

¹ Balkbro= beam bridge GC= pedestrian and bicycle bridge Lådbalksbro= Box bridge

Plattbro= slab bridge Väg= road traffic bridge Fackverksbro= Truss bridge

² Glulam – glue laminated wood product of various sizes and shapes

however forbidden in Sweden because of the possible environmental impact of the impregnation chemical. On the contrary, it is widely used in Norway and Finland where much more road bridges are made from timber. More useful information can be found at Träguiden (2011).

4.3.1 Stress-laminated plate

Description: This type of bridge is the most common timber solution in Sweden for traffic bridges (Figure 4.17). Stress-laminated bridges are economically competitive compared to other materials in very short spans - up to 10 m. They rely on the simply supported slab action - a number of rectangular beams (mostly glulam) are joined and prestressed against each other by means of transverse steel rods (Figure 4.18).



Figure 4.17 A typical example, Martinsons (2011).

Advantages: Sustainable; fast assembly; low self-weight; simple construction.

Drawbacks: Possible durability problems; shorter lifespan; limitation of traffic volume, since cracks from differential settlements can occur at the asphalt surface; possible restriction in width with regard to the high prestressing forces that would be needed for wide bridges (with more than three lanes).

Optimal span: 6-14m, maximum 15m , acc. *Träinformation* (1996)

Span-to-depth ratios: 20-30

More information: *Träinformation* (1996)

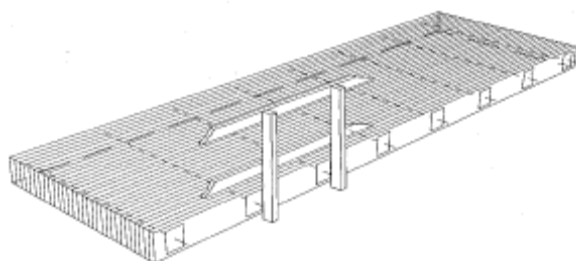

Figure 4.18 Principal scheme of stress-laminated bridge, from *Vägverket* (1996)

4.3.2 Beam with timber deck

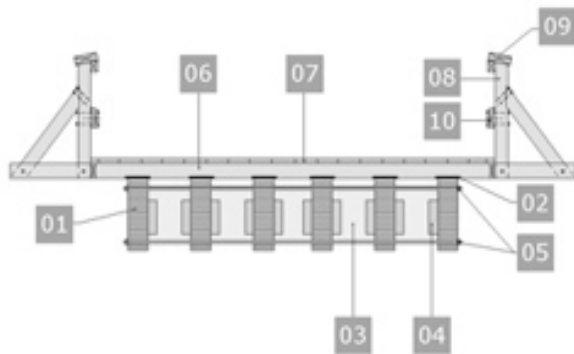

Figure 4.19 Cross-section of Skeppsvik bridge, from *Träguiden* (2011)

Description: This bridge type represents a solution for longer spans and mostly for pedestrian purposes. However, it is also used for road traffic, although not very often and with a lifespan of 40 years (Figure 4.19).

Advantages: Sustainable and aesthetically neutral; fast assembly; low self-weight.

Drawbacks: It needs good detailing; higher construction height; need for bracing; probably more expensive than concrete alternatives.

Optimal span: up to 15m for road traffic (needs more research).

Span-to-depth ratios: 15-20.

More information: *Träguiden* (2011), *Martinsons* (2011)

4.3.3 Beams with LVL¹ deck

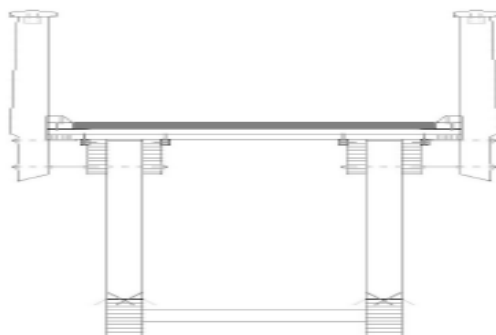

Figure 4.20 Cross-section of bridge with LVL deck, from *Tosi* (2010).

¹ LVL – is an engineering product similar to plywood. It is a Laminated Veneer Lumber plate which is orthotropic and is made of lamels (layers). KertoQ® and KertoD® are market products of Finnforest Corporation.

Description: This bridge type includes a relatively new concept for the decking. It makes use of the orthotropic properties of LVL, so that the deck works as a slab (Figure 4.20). This alternative is very suitable for pedestrian purposes, but is still not allowed for use in road bridges by the Swedish Transport Administration (Trafikverket).

Advantages: Sustainable and aesthetically neutral; fast assembly; low self-weight; the LVL deck provides lateral stability, so there is no need of bracing.

Drawbacks: It needs good detailing; higher construction height; probably more expensive than concrete alternatives; not enough experience.

Optimal span: Up to 15m for road traffic (needs more research).

Span-to-depth ratios: n.a.

More information: *Martinsons (2011)*

4.3.4 Hanging truss

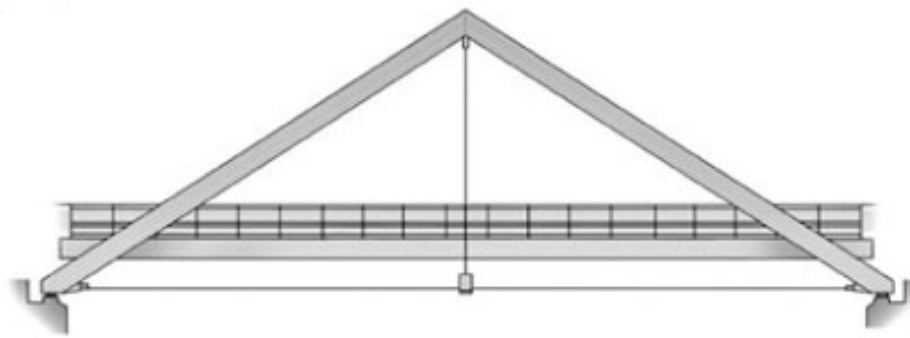

Figure 4.21 Principal scheme of hanging truss bridge, Martinsons (2011)

Description: This solution relies on a simple truss action with the help of steel ties in the middle to transfer the load to the timber diagonals (Figure 4.21). Moreover, steel ties between the end supports are needed to take the internal horizontal forces. The loads from the deck are transferred to a transverse beam in the middle, which is connected through the vertical ties to the timber diagonals. Bracing at the top is needed for horizontal lateral stability.

Advantages: Sustainable and aesthetically pleasing; fast assembly; low self-weight.

Drawbacks: It needs good detailing; possible durability problems; probably more expensive than other alternatives.

Optimal span: 16-23 m

Span-to-depth ratios: 4-12.

More information: *Träinformation (1996), Martinsons (2011)*

4.3.5 Lower arch



Figure 4.22 Timber arch bridge near Margretelun , Martinsons (2011)

Description: This structural type relies on glulam arches working mainly in compression. Only two road bridges of this type are built in Sweden (Figure 4.22). However, worldwide it is used more often for the purpose. The timber arch is very suitable for pedestrian bridges with longer spans (up to 60 m). This solution is very appropriate for valleys as the arch provides the logical leap over the gap.

Advantages: Sustainable and aesthetically very pleasing; fits the landscape; fast assembly.

Drawbacks: It needs good detailing; possible durability problems; probably more expensive than other alternatives (like concrete); not suitable in clay due to high horizontal forces that need to be accommodated.

Optimal span: 28-35m (in case of road traffic).

Span-to-depth ratios: n.a.

More information: Martinsons (2011)

4.4 Composite bridges

4.4.1 Steel I-girders and cast in-situ concrete deck

Description: In this bridge type most often two or more (depending on the width of bridge) I-girders (Figure 4.23) are fabricated and placed on the ready supports (abutments). After this, the steel girders are used to support the formwork needed to cast a concrete deck in-situ. Special attention is drawn to the connection between steel top flange and the concrete deck, as it has to transfer longitudinal and transversal shear forces. The concrete deck usually has end walls like the bridge type described in Section 4.1.4.

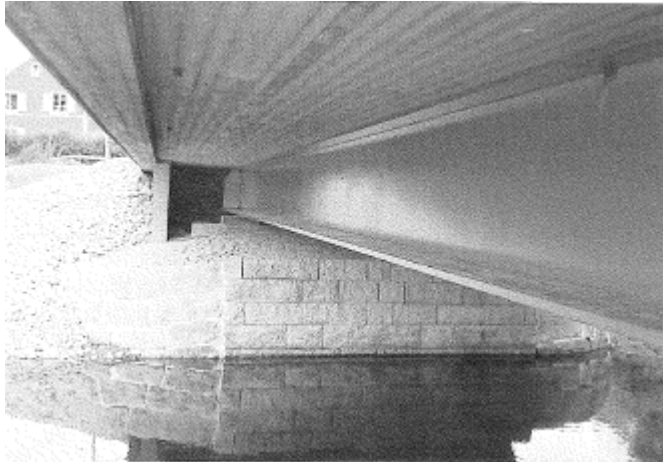

Figure 4.23 Composite bridge with steel I-girders and elevated foundations, from Vägverket (1996)

Advantages: This bridge type has a short construction time; is suitable for colder climates as less man-hours are needed; ability to carry the deadweight of the formwork (Collin, 2006); possibility to lift the level of the foundation slab, i.e. avoiding working in water.

Drawbacks: higher initial cost of the materials compared to pure concrete solution.

Optimal span: > 20 m; 16-18 m for hot-rolled cross sections.

Span-to-depth ratios: 20-25 (single span); 30-35 (two spans).

More information: Collin (2006)

4.4.2 Steel I-girders and prefabricated concrete deck panels

Description: This bridge type is very similar to the one presented in Section 4.4.1, but here the deck consists of prefabricated concrete elements instead of being cast in-situ. This solution is even more competitive in terms of time and optimisation, but raises some additional technical difficulties. One of them is how to transfer the horizontal shear forces between steel top flange and the prefabricated concrete deck. Second is how to transfer vertical shear forces between neighbouring elements (Figure 4.24). Another demand concerns high quality of fabrication, as tolerance requirements are often very demanding. According to Collin (2006), the costs of prefabricated and cast in-situ decks are almost the same; some contractors even stated that prefabricated panels are cheaper.

This concept is gaining popularity in Sweden and the Swedish Transport Administration is satisfied with it. It is mostly used when time is a major factor and a fast solution is needed.

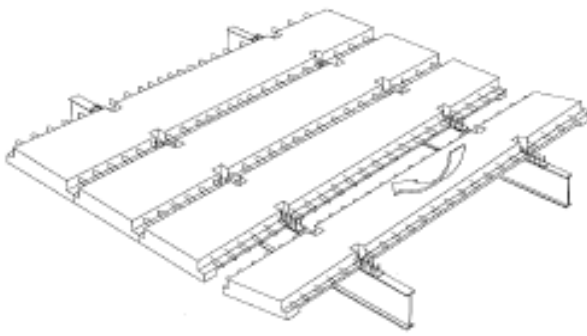

Figure 4.24 Composite bridge with prefabricated deck elements, from Vägverket (1996)

Advantages: Very short construction time; suitable for colder climates as less man-hours are needed; increased quality; ability to carry the deadweight of the formwork (Collin, 2006).

Drawbacks: Higher demands on tolerances, very little allowance for late changes, little flexibility in design and shape.

Optimal span: > 20 m.

Span-to-depth ratios: 20-25 (single span); 30-35 (in case of two spans).

More information: Collin (2002)

4.4.3 Steel I-girders and FRP deck



Figure 4.25 Example of FRP deck panels (FiberSPAN™) panel placed on steel grid, from Composite Advantage (2011)

Description: This bridge type represents a very new trend in bridge engineering, where different types of polymers are used. It is mostly used for pedestrian bridges, but more and more research is carried out in the field and concerning its application for road bridges, especially in USA and UK. The fibres are mostly from glass, carbon

or aramid. FRP decks are still very costly solutions, but are gaining popularity because of their advantages. FRP can be used for the deck only (see Figure 4.25) or for bridge elements T-sections (see Figure 4.26) which provide both beams and deck functions.



Figure 4.26 Example of FRP bridge elements with T-section, SuperFiberSPAN™, from Composite Advantage (2011)

Advantages: High resistance to corrosion and chemical agents; excellent strength-weight ratio; superior durability; very easy prefabrication and erection; can be skewed; ability to mould complex forms.

Drawbacks: High initial cost; potential for material degradation (UV, alkali etc.); creep and shrinkage; limited knowledge and experience.

Optimal span: 8-18m (according to the authors).

Span-to-depth ratios: n.a

More information: Composite Advantage (2011); National Composites Network (2011).

4.4.4 Timber girders and cast in-situ concrete deck



Figure 4.27 Example of composite bridge from Germany, property of Miebach Ingenieurburo (2011).

Description: This solution relies on composite action between a timber girder system and a reinforced concrete deck (Figure 4.27). The connection is made by shear connectors in order to transfer forces at the joint interface such that a composite 'T'- section is achieved (Figure 4.28). With the introduction of Eurocodes these solutions are nowadays allowed in the Swedish practice.

Advantages: It utilises well the strengths of the two main materials; good aesthetically; lower deadweight; the concrete deck gives good protection of the timber girders.

Drawbacks: Little knowledge; special attention to the connectors.

Optimal span: 8-15m (according to the authors).

Span-to-depth ratios: n.a

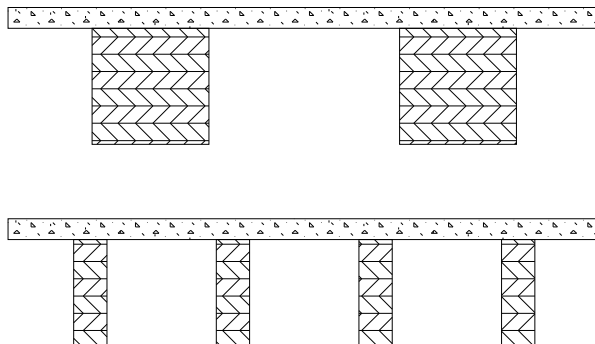

Figure 4.28 Cross sections

4.4.5 'Folded plate system'



Figure 4.29 Folded plate concept, taken from Highway Bridge Services (2011)

Description: This bridge type is a new system developed by the University of Nebraska - Lincoln, USA. The system utilises composite action between – steel girders folded in a factory and a concrete deck cast at the site or in the factory (Figure 4.29). It is very suitable for short spans for secondary roads. As the bridge's cross-section is almost a closed box (Figure 4.30), it has good torsional stiffness and lateral stability, i.e. very easy to mount and erect.

Advantages: Very rapid manufacturing and delivery; stability and safety during construction; no need for bracing and stabilisers; easy inspection compared to traditional closed box girders.

Drawbacks: Innovative - research is still ongoing; not a flexible solution.

Optimal span: up to 20 m. (Restricted by manufacturing equipment).

Span-to-depth ratios: n.a.

More info: *Highway Bridge Services (2011)*

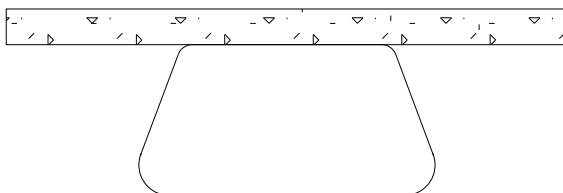

Figure 4.30 Cross section

4.5 Summary

The solutions presented in this chapter are the most common and suitable for short-span bridges for road and railway traffic. Along with the standard bridges, such as the concrete slab-frame, some solutions according to new trends are introduced giving the engineer a broader perspective and empowering his or her creativity. The list of solutions can always be updated and new solutions can be included. The properties written under 'advantages' and 'drawbacks' are however often subjective and not all of them rely on scientific evidence. This is stated by Löfqvist (1994) where he points out that the most difficult part in creating a knowledge-based system for conceptual design is to acquire generally accepted conclusion of what is possible and in, which situation.

5 ‘Demand-solution’ guidelines for conceptual design

5.1 Approach and limitations

The output of the proposed procedure for conceptual design of short-span bridges points out, which concepts or structural systems are the most suitable for a given design case. The promising solutions are chosen from a fixed number of the most common bridge types for short-span bridges for road or railway traffic. The step-by-step approach is divided in four distinct levels with sublevels. All of these are described in detail in the following sections. The methodology of creating the guidelines was a constant iterative process with continuous evaluation. Feedback was received focusing on practicality and applications in current conceptual design practice. Two case studies were carried out, see Chapter 6, to further calibrate and improve the proposed guidelines.

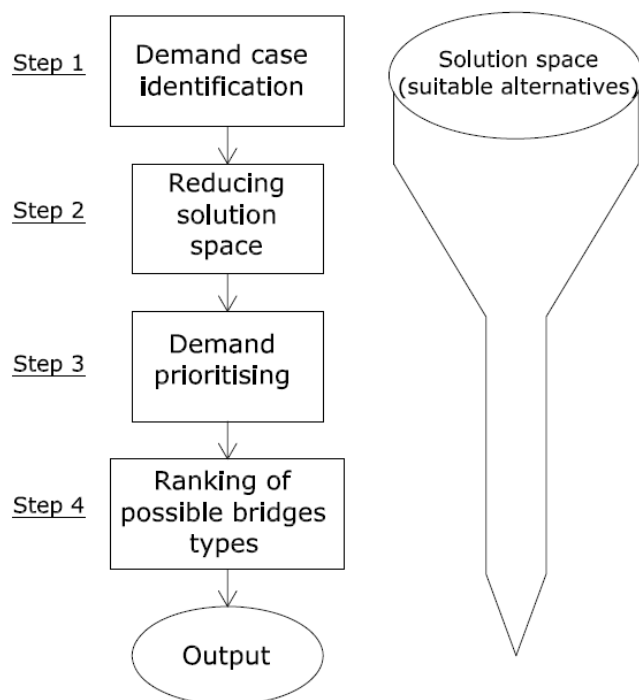

Figure 5.1 ‘Demand-solution’ step-by-step methodology scheme

The proposed structure of the methodology is seen in Figure 5.1. The solution space on the right shows that the number of appropriate solutions is reduced as the user goes through the design process. A toolbox supporting the methodology was developed on the base of Microsoft Excel and made semi-automated to simplify the work of the user and increase his or her speed. Moreover, it is structured in a way such that the procedure is transparent and easy to follow.

The first step is concerning mostly the input, while the last step is more output (result) oriented. All the steps and stages of the methodology and the developed Excel toolbox can be seen in detail in Appendix A.

The guidelines were developed with some important points in mind:

- Versatility – the proposed toolbox covers as many different design situations as possible. It can be used for 'General' or 'Total' contract with the only difference concerning 'demand prioritising' (see Section 5.2.3).
- Flexibility – the whole guideline has an open structure and was developed in a way such that it can be further developed and even expanded (longer spans; pedestrian bridges). It allows for further improvement such as adding new solutions, changing the contents and fixed parameters. The focus of the authors was on the methodology, not on the precision of the content itself as it can be easily improved with further work.
- Balance – although some decisions and exclusions are made by the toolbox without the user's approval, the designer still has control and freedom over the final solution. Neither is the guideline too vague, nor it takes final decisions without using the engineer's expertise.
- Visualisation and dialogue – the created toolbox can be used as a tool to present to the client a structured way of work and even extract his or her input simultaneously. The speed of the toolbox provides good options to make changes on the spot and propose different solutions during the meetings.

The limitations of the toolbox are as follows:

- The maximum allowed input length is 30 (32) meters.
- This version of the toolbox with supporting guidelines disregards pedestrian bridges, although the possibility to include pedestrian and bicycle lanes is considered for road or railway bridges.
- Only road and railway bridges are covered by the guidelines.
- Up to five predefined solutions (promising alternatives) can be compared at the same time, plus two additional solutions added by the user manually.

5.2 General description and aim

This step comprises of set of questions (questionnaire) that helps to define the actual design situation as much as possible. Referred to as the main menu as well, this part stores decisions and project information more consistently. Each question is explained by a description, alternative answers and which solutions that are excluded for a certain answer. For each question **one** answer must be selected. The two main purposes of the input questionnaire are: definition of design case and documentation of the conceptual design process and situation. Most of the exclusions are based on the knowledge the authors from practising engineers. This was achieved by analysing questionnaires sent to engineers and by interviews. After detailed interviews and

literature studies, thirteen demand cases (design situations) were selected as the most common. With a given input, the methodology will identify, which of the cases is most similar to the actual design situation. Even though the formal design situations are reduced to a limited number, the methodology is still flexible and more cases can be added when further improvements are needed. If the reader is unsure about which bridge types the authors are referring to; he or she is advised to look in Chapter 4.

5.2.1 Step 1 – Demand case identification

5.2.1.1 Description of the questionnaire:

To start with, three primary demand parameters according to Section 3.3 are specified: type of traffic, type of obstacle and type of soil (geotechnical conditions). This is the initial input to the conceptual design process and its aim is to define in which demand case the current project falls into according to Table 5.1.

Table 5.1 Demand cases (design situations)

Case	Description	Visualisation
1	Road bridge over railway or road	
2	Road bridge over pedestrian passage	
3	Road bridge over water	
4	Railway bridge over water	
5	Railway bridge over Road	
6	Road bridge over railway or road	
7	Road bridge over pedestrian passage	
8	Railway bridge over water	
9	Road bridge over railway or road	
10	Road bridge over pedestrian passage	
11	Road bridge over water	
12	Road bridge over water+fauna	
13	Road bridge over water+fauna	
	Frictional material	
	Clay (or cohes. soil)	
	Rock	

The logic behind Table 5.1 is explained in Chapter 3. Pedestrian and bicycle bridges were excluded in this version of the guidelines. The main reason for that is that pedestrian bridges give the designer very big freedom in the choice of concept and

solution. This makes it very difficult to categorise the most bridge types. Moreover, trying to industrialise and classify pedestrian bridges seems to restrict and discourage the designer instead of fuelling his creativity. Pedestrian bridges have much bigger aesthetical demands and possibilities and this is there where engineers and architects push the limits of technology and art. Another reason for excluding pedestrian bridges was the need to fit in the timeline of the thesis project. Although including pedestrian bridges can be possible, it requires more time for research to describe and classify the vast variety of these structures.

If a given design situation cannot be classified precisely by one of the 13 options or is a combination between them (for example the obstacle is both water and a pedestrian pass), the user is advised to focus on the main characteristics or decisive points. For example, the road traffic load will be the governing factor for the solution, even though the bridge will have a pedestrian walkway as well. If two standardised demand cases are very close, the user is advised to make the whole procedure twice and then assess the results. Finally, it is unlikely that a certain bridge project will fall outside all of the standardised cases unless it is longer than 30 m (outside the scope of the thesis work) or it is a quite unique and special case where generalising will not be advantageous.

The three primary questions are as follows:

1. What type of traffic is the bridge designed for?

- Road traffic and/or fauna – see Section 3.3 for explanations
- Railway – it is not differentiated for what type of speed; if high speed rail is the case, special analysis is needed.

Exclusion of bridge types:

- In case of a railway bridge all timber solutions (Section 4.3) are excluded as options. All composite bridges (Section 4.4) except steel girders with in-situ concrete deck are disregarded since knowledge about their performance for railway loads seems to be limited.

2. What type of obstacle does the bridge need to cross?

If a combination of obstacles is present, the user must select the dominating one that causes the highest demands and requirements).

- Water – can be a creek, stream, channel or a small river.
- Road and/or railway – at this stage no differentiation is made between road and railway as they put similar demands and the only difference is the needed clearance height.
- Pedestrian and bicycle passage – observe that a pedestrian passage means a pedestrian path under a road or railway not above.
- Fauna passage (and water) – a natural path for animals, which has to be preserved. Very often it is accompanied by a water source (stream, river).

Exclusion of bridge types:

- Corrugated steel arch (Section 4.2.1) is excluded when the obstacle is a road and/or a railway.
- Prefabricated concrete tunnel (Section 4.1.10) is generally used when the obstacle is a pedestrian or bicycle passage and all other alternatives are excluded.

3. What is the predominant ground condition?

The predominant ground (soil) condition at the site is specified as:

- Clay or cohesive soil.
- Rock – if rock mass is present, the ground conditions are generally considered to be very good.
- Frictional material – can be sandy soil, moraine or other type of cohesion less soil.

If it is obvious that there is a thin layer of poorer soil, which can be easily removed, then the soil beneath should be considered for the main condition.

Exclusion of bridge types:

- In case of clay or cohesive soil, prefabricated concrete solutions such as precast hollow core elements, precast beams and precast tunnels are excluded due to possible problems with differential settlements and reduced robustness of these solutions. Moreover, the timber arch (with the traffic above it) is disregarded, as it is very difficult to resist high horizontal arch forces in cohesive soil.
- In case of rock, solutions with integral abutments are removed as they always rely on piling.

After answering these three primary questions, a result like the one exemplified in Table 5.2 will be obtained. At the same time some of the bridge types have been excluded and a certain number remains accordingly, see Table 5.4. The numbering of the solutions is according to Figure 5.4.

Table 5.2 Demand space – example of case identification

Demand space					
Case	Description	Visualisation	Code	Status	
1	Road bridge over railway or road		A1 B2 C3	FALSE	
2	Road bridge over pedestrian passage		A1 B3 C3	FALSE	
3	Road bridge over water		A1 B1 C3	ok	
4	Railway bridge over water		A3 B1 C3	FALSE	
5	Railway bridge over road		A3 B2 C3	FALSE	
6	Road bridge over railway or road		A1 B2 C1	FALSE	
7	Road bridge over pedestrian passage		A1 B3 C1	FALSE	
8	Railway bridge over water		A3 B1 C1	FALSE	
9	Road bridge over railway or road		A1 B2 C2	FALSE	
10	Road bridge over pedestrian passage		A1 B3 C2	FALSE	
11	Road bridge over water		A1 B1 C2	FALSE	
12	Road bridge over water+fauna		A1 B4 C2	FALSE	
13	Road bridge over water+fauna		A1 B4 C1	FALSE	

After completing the demand case identification, the user should continue answering the questions of the questionnaire. Hereafter, they are described thoroughly.

4. What is the expected (provisional) length of the bridge?

Here the user has to input the preliminary length of the bridge (see Figure 5.2 for definitions) in the range from 2 to 32 meters. Even though the scope of the thesis project is short-span bridges with a length less than 30 meters, a margin is provided. The tolerance given is $\pm 1\text{m}$, as it is very difficult to specify an exact length at this early stage. Important to point out is that the bridge can have two or more spans but the total length should be less or equal to 32 meters. Even though the length can be a part of the solution and somehow restricts the designer in the following steps, this input is important in order to further reduce the amount of solutions, possible and/or appropriate. It is very common that the designer has freedom to change the level of the road (for new roads or railways), thus varying the needed length of the bridge (see Figure 5.2). In such case the user is advised to use the methodology twice with both options. Later change of the bridge length is always possible. Hence, an important aspect is whether the bridge length is fixed or can be chosen within an interval. This is why the span ranges must be updated and verified continuously. Visualisation of proposed span ranges for different bridge types is presented in Table 5.3.

In the Excel toolbox the specified length for the actual design situation is compared to the optimal and possible span range for each of the bridge types. This is done

automatically, but the designer is always advised to double-check and asses, if the proposed reduction of possible bridge types is reasonable.

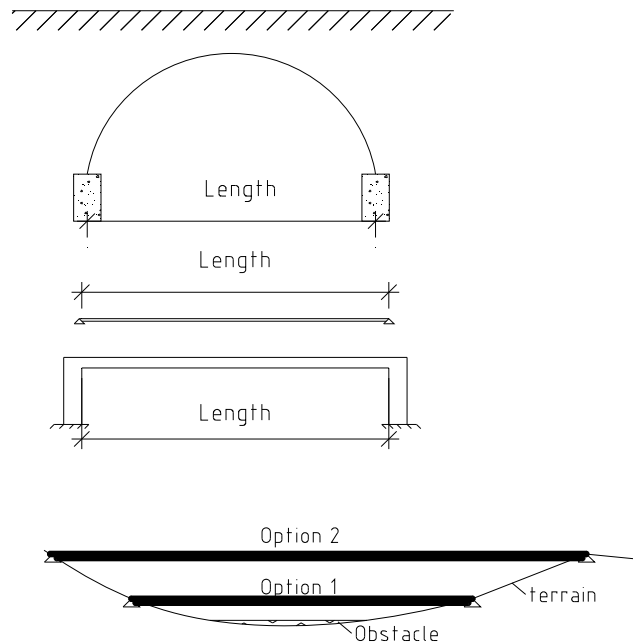

Figure 5.2 Length of bridge compared to elevation of road (vertical profile)

By specifying the length in the toolbox, bridge types that fall out of the possible intervals will be disregarded. This exclusion is mostly based on cost and tradition considerations. Three status levels exist (Table 5.3):

- ‘OK’ – The length is considered optimal for the bridge type.
- ‘OK?’ – The bridge type is satisfactory for the given length, but probably not very optimal. The designer manually decides whether to disregard the bridge type or not.
- ‘Outside’ – The bridge type is considered inappropriate for the given length.

In the column ‘prestressing’ it is advised to use prestressing if ‘P’ is shown. If ‘P+’ is shown, prestressing is considered to be necessary.

Exclusion of bridge types: Bridge types not appropriate for the specified length are excluded. An example of output from the toolbox is shown in Table 5.3.

Table 5.3 An example of length exclusion

Hint: Mark the column representing your input span for easier visualisation.

Span length ranges for different solutions

Nº	ROAD TRAFFIC	Status	Prestr.	Length [m]	2	3	4	5	6	7	8	9	10	11	12	13	14	15	16	17	18	19	20	21	22	23	24	25	26	27	28	29	30	31	32	33	34	35	Nº		
1	<u>Solution:</u>																																								
1	Slab-frame in-situ	OK	OK	12																																					
2	Beam-frame in-situ	Outside	OK	12																																					
3	Integral abutments	OK?	OK	12																																					
4	Simply supported slab in-situ	OK	OK	12																																					
5	Simply supported beam in-situ	Outside	OK	12																																					
6	Prefab. hollow core	Outside	OK?	12																																					
7	Prefab. pre-tensioned beams	OK?	OK?	12																																					
8	Prefab. pedestrian tunnel	Outside	OK	12																																					
9	Corrugated steel arch	Outside	OK	12																																					
10	Stress-laminated plate	OK	OK	12																																					
11	Beam bridge with timber deck	OK	OK	12																																					
12	Beam bridge with LVL deck	OK	OK	12																																					
13	Hanging truss timber bridge	Outside	OK	12																																					
14	Timber arch bridge	Outside	OK	12																																					
15	Steel I-girders and in-situ RC deck	Outside	OK	12																																					
16	Steel I-girders and prefab. deck	Outside	OK	12																																					
17	Steel I-girders and FRP deck	OK	OK	12																																					
18	Timber girders and in-situ RC deck	OK	OK	12																																					
19	"Folded plate system"	OK	OK	12																																					

Back to main menu

OK
OK?
"Outside"
P
P+

optimal
satisfying (solution is not very optimal)
not satisfying (not appropriate)
prestressing advised
prestressing needed

Nº	RAILWAY TRAFFIC	Status	Prestr.	Length [m]	2	3	4	5	6	7	8	9	10	11	12	13	14	15	16	17	18	19	20	21	22	23	24	25	26	27	28	29	30	31	32	33	34	35	Nº		
1	<u>Solution:</u>																																								
1	Slab-frame in-situ	OK	OK	12																																					
2	Beam-frame in-situ	OK?	OK	12																																					
4	Simply supported slab in-situ	OK	OK	12																																					
5	Simply supported beam in-situ	Outside	OK	12																																					
9	Corrugated steel arch	Outside	OK	12																																					
15	Steel I-girders and in-situ RC deck	Outside	OK	12																																					
20	Through concrete beam in-situ, flat	OK	OK	12																																					
21	Through concrete beam in-situ, ribbed	OK	OK	12																																					

5. Can construction work be carried out in the obstacle area?

This questions concerns the local site conditions - difficult geometry or inability to work in the obstacle area (see Figure 5.3 for definitions). The purpose is to assess the availability of space for formworks, construction works and other technological procedures and limitations.

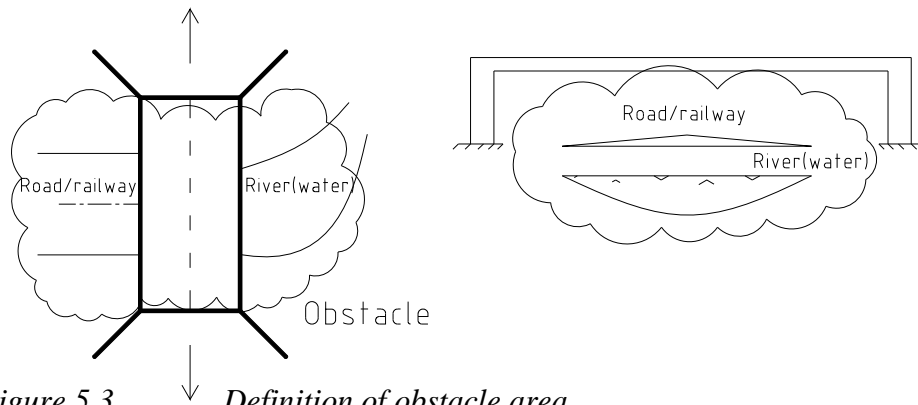

Figure 5.3 Definition of obstacle area

- Yes – there are no problems to work in the obstacle area (see Figure 5.3). The obstacle can be one of the mentioned in Question 2. If a water obstacle is present, it is a permitted to work in water. If small restrictions exist, they are not severe and can easily be managed with little resources (time, money, machinery, stop of traffic).
- Yes, but with some restrictions or difficulties – work is restricted by either geometrical limitations or environmental restrictions (work in water for example). Traffic cannot be stopped, but can be restricted with reduced capacity (speed). For instance, a middle support can be constructed while traffic is running.
- No – no work can be done in the obstacle's area neither around it (except abutments).

Exclusion of bridge types:

- If 'Yes, but with some restrictions or difficulties', all cast in-situ solutions are proposed for exclusion. It is assumed that temporary formwork can be provided but with a sufficient span without affecting the space beneath the new bridge (obstacle area). It is assumed that the slab-frame bridge can be cast beside and launched into its final position, if this possibility exists.
- If 'No' and railway traffic in the obstacle is present, all cast in-situ frame solutions are removed, because of their need for extensive formwork. Various building techniques and ways of transportation to the site exist for simply supported slabs and beams for railway solutions (see Sections 4.1.4, 4.1.5, 4.1.7 and 4.1.8) (Banverket, 2007). For road traffic all cast in-situ options are removed.

6. Is construction time of major concern (crucial importance)?

Has the client stressed time to be of main concern or is it understandable as default for the actual project? Is there an urgent need for a bridge or would the bridge construction cause complete traffic stop, reduce its capacity or disturb other processes? Would the bridge construction cause big changes in logistics and/or financial losses? Depending on the actual situation one of the following two alternative answers is selected:

- Yes
- No

Exclusion of bridge types:

- In case of 'Yes', all cast in-situ solutions except the slab-frame are disregarded. It is assumed that these are the most time consuming and would not be suitable if the client demands fast construction. The slab-frame option can be cast besides and launched to its position (if 'Yes' to Q5), thus keeping the existing road/railway operate as much as possible.

7. Is this a new road/railway for the traffic (no bridge already exists)?

Is the project aimed for a completely new road or railway? If a road/rail exists and traffic is running and operation cannot stop, then it is a replacement of a bridge (or its deck). In this case choose 'No'. It is important to remember that the question concerns the traffic and not the obstacle.

- Yes
- No

Exclusion of bridge types:

- In case of a bridge replacement ('No') and inability to work in the obstacle area ('No' to Q5), corrugated steel arch is removed due to the nature of its construction process.

8. Is there a possibility to place a middle support in the obstacle area?

This question clarifies whether a support can be placed or not. For instance, can a middle support be placed in water or in the middle of a two-lane road?

- Yes
- No

Recommendation for Exclusion of bridge types:

- If 'Yes' and the input span is above 20 m, the designer is advised to consider a continuous bridge, but probably with not more than 2 spans considering the total length limit of 30 meters.

9. What is the needed bridge shape (in the horizontal plane)?

If there is a requirement from the landscape architect or the client for layout of the bridge (Figure 5.4), it is taken into account here. In addition, the designer can also make a decision with regard to local geometrical conditions.

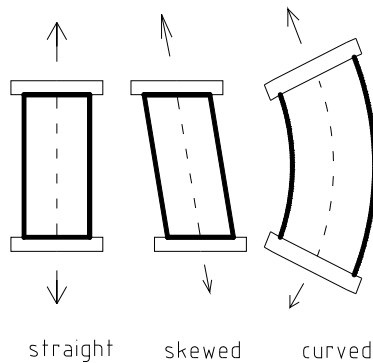

Figure 5.4 Various horizontal layouts

This question is answered by one of the following alternatives:

- Straight – the centreline of the bridge is perpendicular to its abutments.
- Skewed (at a skew angle) – the bridge’s centreline is at an angle different from 90 deg to its abutments.
- Curved – the bridge has to follow a horizontal curve.

Exclusion of bridge types:

- If ‘Skewed’ is chosen, prefabricated concrete solutions (see Section 4.1) are removed, because of possible problems with differential settlements, transfer of torsional moments and restrictions with regard to the production process. Moreover, hanging timber truss (Section 4.3.4) and arch bridges (Section 4.3.5) are excluded, since asymmetry causes complications for calculation and production of timber bridges of these types.
- If ‘Curved’, all prefabricated concrete solutions (Section 4.1.8, 4.1.9 and 4.1.10), timber solutions (Section 4.3), composite (Section 4.4) (except with steel and concrete (numbers 15 and 16)) and corrugated steel arch are removed. This is mainly because of technical or production issues.

10. What is the needed position in the vertical plane?

If there is a specific requirement from the landscape architect or the client concerning the vertical layout, the designer should choose one of the following options (Figure 5.5). Here it is important to identify a need for a distinguished vertical curve.

- Horizontal or inclined
- In a vertical curve

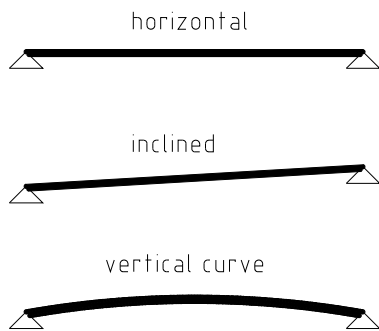

Figure 5.5 Various vertical layouts

Exclusion of bridge types:

- If ‘In a vertical curve’ is selected, prefabricated concrete solutions (precast hollow core, precast beams), stress-laminated timber bridge and ‘folded plate’ system are removed due to technology and production issues.

11. Other special requirements.

Here the user is asked to write down any other requirements or demands specific for the actual project. Some special circumstances or conditions should be described as well. Documentation is vital for knowledge storage and developed design procedures in the future. For example, after having used this methodology for a number of bridges, the designers can track a trend in their decisions and probably implement it back into the toolbox as definitive advices.

12. Where is the bridge situated?

- Urban area – city centre or very populated area.
- Highway area (suburban) – around a highway region or in the outskirts of a city; industrial area with few inhabitants.
- Countryside – a bridge outside living areas, mostly on intercity roads or railways.

Recommendation for Exclusion of bridge types:

- If the bridge is located in an urban area, timber bridges might be difficult to fit into the built environment.

13. What is the needed width of the bridge or how many lanes/lines are needed?

- Single lane/line
- (2-3) lanes/lines

- 4 lanes/lines or more

Exclusion of bridge types:

- If the bridge needs to be accommodate four lanes/lines or more (i.e. highway) with continuous width (not separated in two parallel parts), all timber solutions are excluded. Since timber bridges are more suitable for smaller roads (lower load, traffic and other effects), it is probably not economically effective to design them for highway use.

5.2.2 Step 2 - Reducing solution space

This step is carried out by the means of the toolbox and accomplishes exclusions of bridge types following the input from Step 1. This step forms the link between the most common design cases and the most common bridge types and is considered as the most difficult and complicated part of the ‘demand-solution’ methodology. The reason for this is the difficulty to give definitive answers to questions like what is appropriate, impossible, and expensive and so on. Often the answers to these are subjective and vary very much from case to case and from person to person. However, the design approach with its guidelines helps the engineer to get a good overview and preparedness to take better decisions.

Three main reductions of the initial solution space are carried out during the process:

- Exclusions after identifying demand case (Table 5.4).
- Automatic exclusion after filling out the input questionnaire (Table 5.5).
- Final subjective exclusion by the designer.

Table 5.4 Demand cases with their respective parts of the total solution spaces

Case	Description	Visualisation	Solution space																			
			1	2	3	4	5	6	7	8	9	10	11	12	13	14	15	16	17	18	19	
1	Road bridge over railway or road																					
2	Road bridge over pedestrian passage																					
3	Road bridge over water																					
4	Railway bridge over water																15				20 21	
5	Railway bridge over Road																15				20 21	
6	Road bridge over railway or road																					
7	Road bridge over pedestrian passage																					
8	Railway bridge over water																15				20 21	
9	Road bridge over railway or road																					
10	Road bridge over pedestrian passage																					
11	Road bridge over water																					
12	Road bridge over water+fauna																					
13	Road bridge over water+fauna																					

Table 5.5 Excluded bridge types depending on various demand parameters

		In question:												
		1	3	5	6	9	9	10	12	13				
1		If railway bridge	If clay work	construction obstacle's area?	no limited time for construction?	If skewed?	If horizontally curved?	If curved vertically?	If located in urban area?	If width ≥ 4 lanes/lines?				
2	Slab frame in-situ													
3	Beam-frame in-situ													
4	Integral abutments													
5	Simply supported slab in-situ													
6	Simply supported beam in-situ													
7	Prefab. hollow core													
8	Prefab. pre-tensioned beams													
9	Prefab. pedestrian tunnel													
10	Corrugated steel arch													
11	Stress-laminated plate													
12	Beam bridge with timber deck													
13	Beam bridge with LVL deck													
14	Hanging truss timber bridge													
15	Timber arch bridge													
16	Steel I-girders and in-situ RC deck													
17	Steel I-girders and prefab. deck													
18	Steel I-girders and FRP deck													
19	Timber girders and in-situ RC deck													
20	"Folded plate system"													
21	Through beam in-situ, flat													
22	Through beam in-situ, ribbed													

 excluded
 proposed for exclusion

After completing Step 1, meaning identifying the actual demand case and answering all the questions concerning the design situation, the designer can start to analyse the solution space. A typical example is shown in Figure 5.6. Each number represents a solution and the ones marked in grey have been proposed for exclusion. The crossed out number are the excluded alternatives. In this case, only solutions 1, 8 and 9 are considered appropriate for the given input and number 10 is up to the designer.

Solution space																				
1	2	3	4	5	6	7			10	11	12	13	14	15	16	17	18	19		
1	2	3	4	5	6	7	8	9	10	11	12	13	14	15	16	17	18	19		
1	2	3	4	5	6	7		9	10	11	12	13	14	15	16	17	18	19		
1	2	3	4	5				9						15					20	21
1	2	3	4	5										15					20	21
1	2	3	4	5					10	11	12	13		15	16	17	18	19		
1	2	3	4	5				9	10	11	12	13		15	16	17	18	19		
1	2	3	4	5				9						15					20	21
1	2		4	5	6	7			10	11	12	13	14	15	16	17	18	19		
1	2		4	5	6	7	8	9	10	11	12	13	14	15	16	17	18	19		
1	2		4	5	6	7		9	10	11	12	13	14	15	16	17	18	19		
1	2	3	4	5				9	10	11	12	13		15	16	17	18	19		
1	2	3	4	5	6	7		9	10	11	12	13	14	15	16	17	18	19		

Figure 5.6 An example of solution space before the final subjective exclusion

At this state the output is critically analysed. Remaining bridge types can still be excluded and other can be added depending on the engineer's own experience. If there is a bridge type left, which is rather impossible or inadequate, it should be removed. However, even if the designer knows that some of the remaining bridge types are not very likely to be optimal, he or she is advised to keep them. The best choice is not always straight forward and it is better to have a broader range of options in the final step. Moreover, the developed toolbox speeds the process so leaving more solutions does not necessarily lead to proportional increase of spent time. After this step a number of promising solutions remain for detailed comparison by means of a ranking matrix.

The adopted approach is semi-automated. Even though some solutions are automatically disregarded, the designer is still the last instance for selecting the concept. This eliminates mistakes such as following' the programme 'blindly'.

5.2.3 Step 3 - Demand prioritising

In Section 2.2 four different approaches for 'key parameter identification' were presented. Considering the scope of this thesis project and desired results, the 'objective tree' was chosen as most suitable approach for comparison and evaluation of various demands. One reason is that it represents a logical system for giving

importance to different parameters. According to Dekker (2000) this method is the most analytical and consistent. It is also very suitable for the task, since at each point the designer and the client can discuss the importance of a certain demand parameter. As in the current practice in Sweden the importance of demand parameters is discussed via a series of meetings, the 'objective tree' can be constantly updated. Another good point of this method is that it shows very clearly and systematically the choices made. Moreover, it allows for two levels of ranking – quick and detailed. This is achieved by using different levels of demands (objectives). The 'objective tree' provides a deeper understanding of the importance of each objective. This is advantageous for keeping knowledge well archived, so that further on the logic and reasons behind decisions is clearly seen. The authors also recommend writing short comments under each grade in order to further clarify the task and decisions for future readers. After completing this part, each aspect of a bridge will have a 'weighting' factor showing its importance qualitatively. A legend of the method is shown in Figure 5.7.

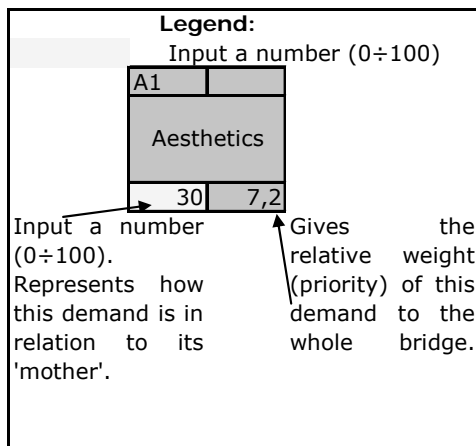

Figure 5.7 Legend of the objective tree

Six general demand areas are formulated in a way (Figure 5.8) that the client can understand them and give proper weights (values) to the so called 'flexible' demand parameters and sometimes even to the 'fixed' ones (from consulting engineer's point of view it is suitable for 'Total contract' where the contractor is the client and production is very important). The number of demand cases and their names were chosen after many iterations and discussions with the designers. 'Fixed' parameters are considered as basic and compulsory, while 'flexible' can be seen as 'extras', which are optional but able to create additional values.

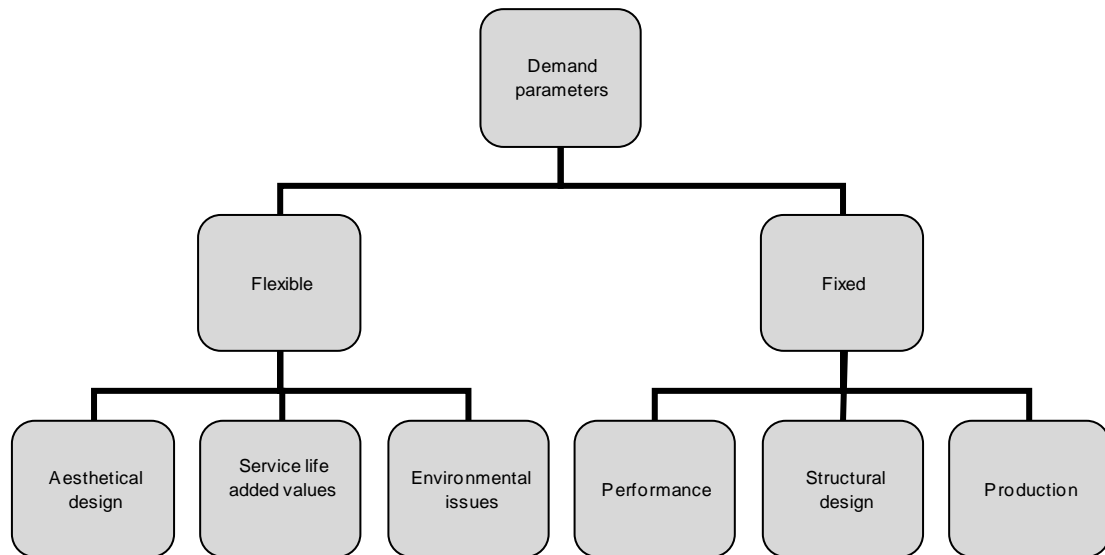

Figure 5.8 Demand tree

The separation into ‘fixed’ and ‘flexible’ areas was made as an attempt to adapt the prioritising of objectives to the needs of the designer and his or her goal to extract the demands of the client better. By giving values to the ‘flexible’ parameters, the client can stress whether and how much he or she is willing to pay for added values in terms of importance. This is done by spreading 100 points between parameters at the same level (Figure 5.9). If the client or the designer cannot decide upon preferences or needs, he or she should distribute the points evenly. In this way the overall result will not be affected, but still the parameters will be considered. Moreover, this approach is an approximation and the values are estimated roughly, thus very much thought is not needed in this early stage of design.

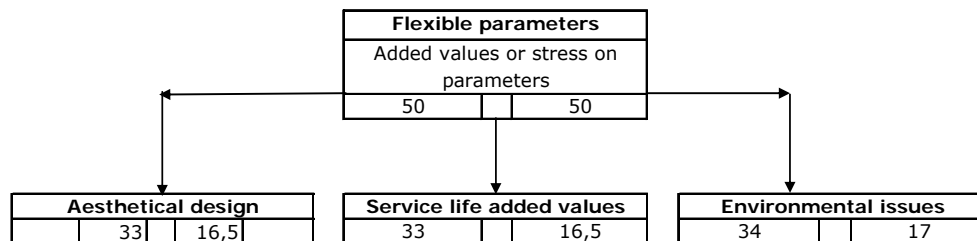

Figure 5.9 Weighting of flexible parameters

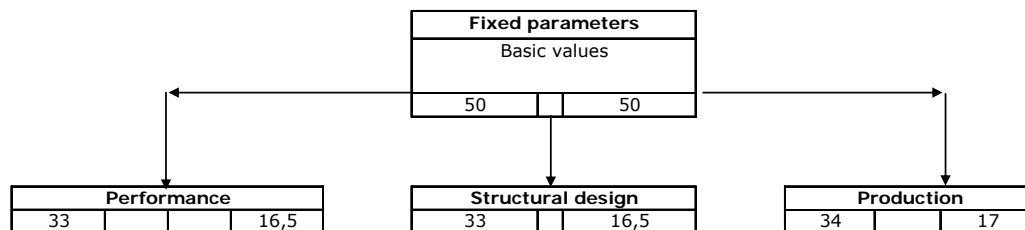

Figure 5.10 Weighting of fixed parameters

Fixed parameters (Figure 5.10) are the basic demands that each solution should satisfy. Sometimes called ‘hard’ parameters, they are very much controlled by the designer and his or her choices. After getting to know the project, the engineers understand the design situation and various demands, thus being able to distribute

values between these three categories. Consequently, the designer is also asked to do the most critical distribution – between the two groups ‘fixed’ and ‘flexible’ parameters (Figure 5.11).

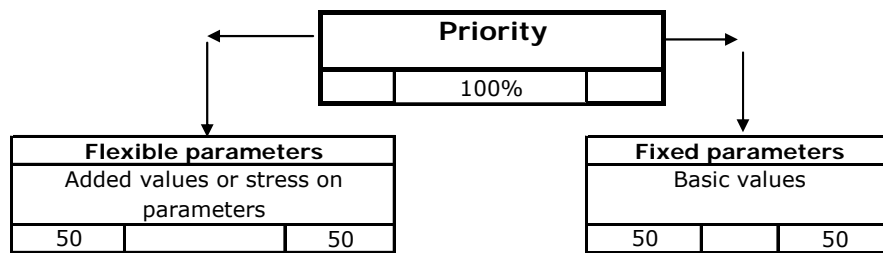

Figure 5.11 Final distribution between ‘fixed’ and ‘flexible’ parameters

Again, if a clear preference to one of them is missing, it is advisable to choose the ratio 50/50. However, if the designer feels that the client demands more added values and is prepared to pay for it, he or she has to account for that by changing the ratio. This decision affects the weighting of the parameters at the later ‘ranking’ step and provides a result representing the client’s demands better.

After distributing values between both ‘fixed’ and ‘flexible’ parameters and their subsidiaries, the designer has two options to proceed depending on his needs:

- Quick evaluation – the input up to Level 2 (Figure 5.12) is enough
- Detailed evaluation – more input for Level 3 is required

When a more detailed analysis of the situations is required, the designer has to provide more input to the ‘objective tree’. This is done by giving importance to the lowest level – Level 3 (from Figure 5.12). Again the same principles are valid as for Level 2.

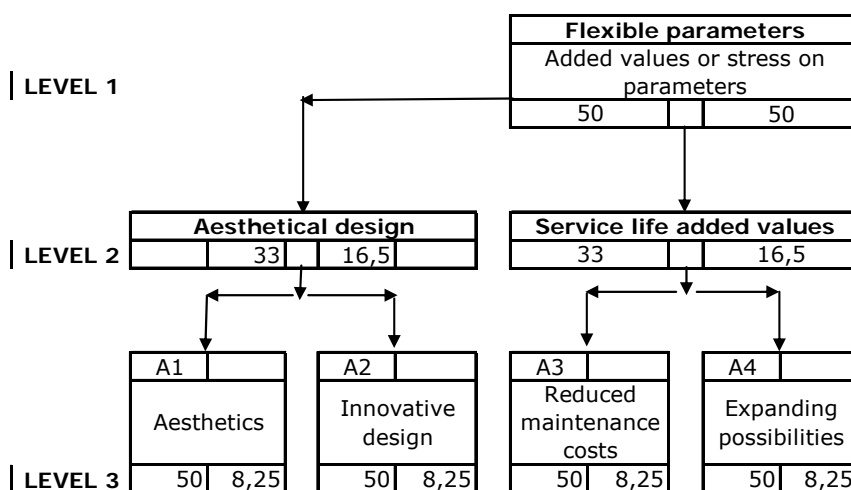

Figure 5.12 Example of objective tree (incomplete) with three levels

A description of all parameters at Level 3 is presented in the following. By answering the questions below and considering their meaning, a deeper understanding of the

project and its demands is achieved. Everywhere 'value' should be understood as importance not actual costs.

5.2.3.1 Flexible parameters

The distribution of values between the flexible demand parameters is preferably decided together with the client or after analysing his or her demands and needs.

a) Aesthetical design

- **Aesthetics** - Describes the importance of architectural and aesthetical aspects of the bridge, such as shape, fit in environment, colour and texture, perception etc. Are there architectural demands to be fulfilled? How much is the client willing to pay for better aesthetics?
- **Innovative design** - Is the client willing to pay extra for a modern or more technically advanced solution? Maybe the project has to be a benchmark or is allowed to be an experimental work.

b) Service life added values

- **Reduced maintenance costs** - This represents the additional cost (importance) that the client is willing to pay for reduced maintenance expenses in the future. Even though this depends on detailing and care during the service life, some concepts achieve this with less resources and difficulties.
- **Expanding possibilities** - Is the client willing to pay extra for solutions, which gives better possibilities for expansion in the future?

c) Environmental issues

- **Sustainability** - Is the client willing to pay extra for a very sustainable solution? Sustainability means here that the product is environmentally friendly, has good recycling possibilities and leaves lower footprint on the ecosystems. However, there are always certain environmental requirements to be taken care of. This parameter can be summarised as 'impact during life span'. For example, a timber solution has excellent sustainability properties, while a cast in-situ slab-frame is inferior in that sense.
- **Impact during construction** - How much is the client willing to pay for reduced environmental impact during construction and how important is that for the project? Impact is understood as amount of construction waste, pollution of the site, disturbance to flora and fauna and disturbance (for instance noise and vibrations) to human population if present.

5.2.3.2 Fixed parameters

The main aim of the 'fixed' demand parameters is to help selecting between different concepts later on in the process. These parameters represent basic requirements that each bridge alternative must satisfy. If the designer considers some of them to be more important than others, he or she is able to reflect this by changing the ratios between them. Different solution has to fulfil fixed requirements, but can do this more

or less easily and for different costs. For example, a slab-frame bridge achieves good robustness easily, while a prefabricated solution needs special consideration and higher cost to ensure this. Since the designer is the link between needs and technical solutions and he or she has most of the information about local site conditions, restraints, and requirements. This makes the designer eligible and able to distribute the importance between these different parameters according to his or her expertise. If the actual client is a contractor ('Total contract'), the 'Production' category can be filled during the meetings as well.

d) Performance

- **Robustness** – How important is structural redundancy to unexpected actions, loads or effects? Can the designer foresee these and if yes, consequently give it more importance? Is a failure of one element crucial for the collapse of the whole structure?
- **Good dynamic behaviour** – How important is good performance under dynamic loading (train, tram, vehicle traffic, seismic loads)?
- **Superior durability** – Assess the relative weight of durability considered as lifespan expectancy and possible durability problems.

e) Structural design

- **Flexibility in design** – Here the flexibility is understood as ability to have different shapes and forms and details. Is variety in shape and form required and advantageous in the actual project?
- **Construction simplicity** – Refers to the experience and technology needed to complete a certain solution. Are the actual circumstances demanding a simpler solution? The local conditions such as qualified labour, machinery and so on should be reflected.

f) Production

- **Flexibility during construction** – this parameter assesses how important it is to be able to cope with unpredicted changes of design during construction for instance due to tolerance problems. Should the solution adopt changes easier and with fewer consequences?
- **Short construction time** – Does the engineer feel that short construction time is very important? It is essential to focus on the time that affects traffic and work in the obstacle's area.
- **Low self weight** – The importance of the self weight of the solution is assessed. It affects both the construction, i.e. need of heavy cranes, machinery, and transport vehicles and also indirectly the foundation complexity. A lighter bridge will require smaller foundation slabs and can lead to cheaper total cost.

To summarise, demand prioritising is the step where the actual demands of the client are identified, evaluated and assigned a weight compared to other demands and the whole. This distribution of values (importance) affects the results significantly and can be decisive for the selection of the final proposal. It is always possible to go back and work in an iterative manner.

5.2.4 Step 4 - Ranking of possible bridge types

The final step of the design approach is ranking and evaluation of the alternatives compared to each other. The grading system (Figures 5.13 and 5.14) is based on the one presented by Niemeyer (2003). The proposed method is not new, but slightly adopted and adjusted for short-span bridges. Moreover, it allows for two approaches - quick and detailed evaluation. The principle is the same; just the amount of time and precision for the detailed approach is higher. By putting grades to each bridge type, the alternatives can be compared qualitatively and more consistently. By this the engineers will avoid as much as possible their subjective and subconscious favourite. Approaching the comparison in this manner is considered as 'normal' and is not representing any special difficulty for the designers (Dekker (2000)). The grading system (0-4) is the same for both approaches. For easy visualisation, grades '0' and '1' are filled with red colour while '4' is green. The ranking by means of ranking matrix is exemplified in Figures 5.14 and 5.15. Detailed pictures and information can be found in Appendix A.

Grading system:	
0 Unsatisfactory	
1 Just tolerable	
2 Adequate	
3 Good	
4 Very good (ideal)	

Figure 5.13 Grading system (based on Niemeyer, 2003)

D E M A N D S		Flexi ble	Weighting coeffi cient	Alternatives			
				8		9	
				Grade	Points	Grade	Points
		Aesthetical design	0,165	2	0,33	1	0,17
		Service life added values	0,165	0	0,00	4	0,66
		Environmental issues	0,170	3	0,51	2	0,34
		Performance	0,165	4	0,66	3	0,50
		Structural design	0,165	2	0,33	2	0,33
		Production	0,170	4	0,68	1	0,17
		Final grade			2,51		2,16

Reset Run

Imported values in % from prioritising of demands ('objective tree').

Input from the user which grades the alternatives according to each property.

Final weighted grade

Value from multiplying weigh. coeff. and grade

Figure 5.14 Example of evaluation (ranking) matrix - quick approach

Hint: Put a grade from (0÷4) to each parameter for each alternative. Here grade 4 is the highest possible i.e. the solution meets the parameter excellently.

				Weighting coefficient	Alternatives				
					2		10		
					Beam-frame in-situ		Stress-laminated plate		
					Grade	Points	Grade	Points	
D E M A N D S	Flexible	Aesthetical design	A1	Aesthetics	0,083	2	0,17	4	0,33
			A2	Innovative design	0,083	1	0,08	4	0,33
		Service life added values	A3	Reduced maintenance costs	0,083	3	0,25	1	0,08
			A4	Expanding possibilities	0,083	1	0,08	3	0,25
	Fixed	Environmental issues	A5	Sustainability	0,085	1	0,09	4	0,34
			A6	Impact during construction	0,085	3	0,26	1	0,09
		Performance	B1	Robustness	0,054	4	0,22	2	0,11
			B2	Good dynamic behaviour	0,054	3	0,16	1	0,05
B3	Superior durability		0,056	3	0,17	2	0,11		
Production	Structural design	B4	Flexibility during design	0,083	3	0,25	2	0,17	
		B5	Construction simplicity	0,083	3	0,25	4	0,33	
	Production	B6	Flexibility during construction	0,056	3	0,17	1	0,06	
		B7	Short construction time	0,056	1	0,06	4	0,22	
		B8	Low self weight	0,058	1	0,06	4	0,23	
				Final grade		2,24		2,70	



Figure 5.15 Example of evaluation (ranking) matrix - detailed approach

Some remarks and rules:

- The maximum number of solutions to compare at the same time is five. However, two more additional boxes are included for concepts, which are not among the bridge types proposed by the authors.
- Assess different solutions by grading them in horizontal order, i.e. give grades to all concepts for one parameter and then continue to the next parameter. In this way the solution is both graded for its own quality and its relative performance to others.
- If the user is uncertain of a grade or some alternatives are very close, it is advised to give the same value for all. By doing so unwanted preferences to a certain option is avoided.
- After filling in all the grades the designer must overview and assess roughly his or her input. Intuition should be applied to confirm the reliability of the result.
- If the toolbox is used after the project has finished (done for comparison), abstraction from already proposed solution should be tried in order to avoid subconscious bias to personal preferences of the designer.
- Due to the semi-automated Excel toolbox, changes can be made immediately, which leads to higher efficiency of the design process.
- By going through the methodology, the designer gets deeper understanding of the project and is more likely to choose the most appropriate alternative.
- The above mentioned drawbacks and some other general remarks are summarised by Pahl and Beitz (1996), see Figure 5.16.

Subjective errors	Shortcomings in the procedure
Abandonment of the neutral position. Designers might unconsciously prefer their own solution. It is better to let the solution be analysed by several persons. Refer anonymously to different design like A, B, C,...	Do not describe something in numbers unless it can be done with some accuracy. If not, it is better to express it in verbal terms like good, bad or very bad.
Comparison of parameters by the application of the evaluation criteria not equally suited to all the alternatives. If it is not possible or not clear how to apply parameters in accordance with the criteria, they have to be reformulated or dropped	Statistically there can be reached a balancing effect as investigated by Stabe [1994]. This is only possible when enough similar cases are known.
The evaluation of the different alternatives should be made for each objective for all alternatives in a row. Otherwise, a designer can gain a preference for a certain design while not judging the other designs objectively	
Inter-dependence between criteria	
Choice of unsuitable value functions	
Incompleteness of evaluation criteria. This can be minimised by a checklist for the corresponding design phase	

Figure 5.16 Some errors and drawbacks of the procedure (Pahl and Beitz (1996))

5.3 Comparison between Niemeyer's 'five-step' and 'demand-solution' methodologies

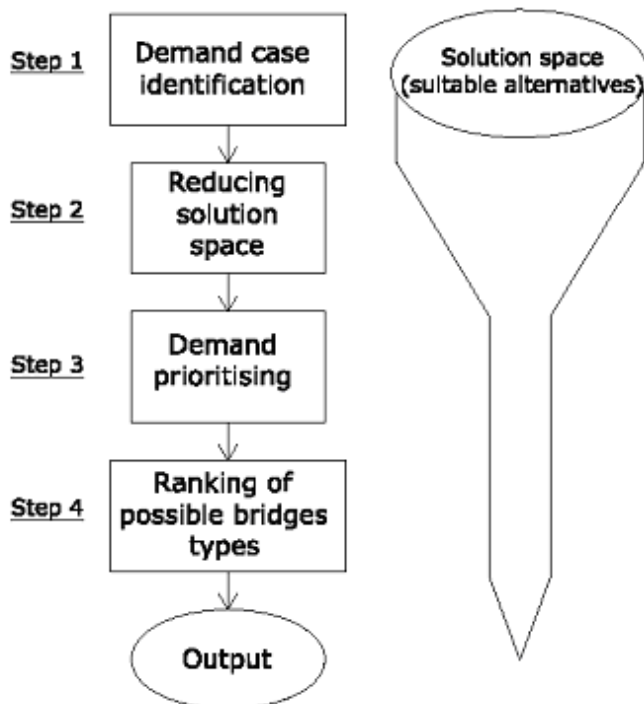

Figure 5.17 'Demand-solution' methodology.

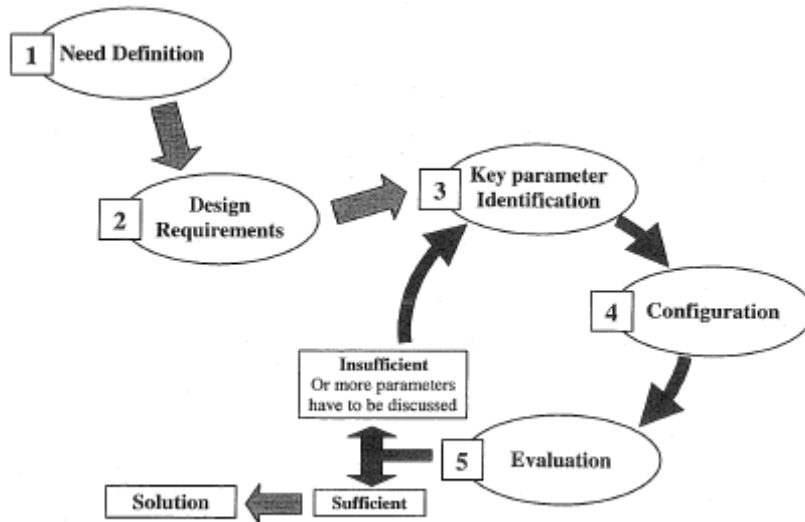

Figure 5.18 'Five-step' methodology, Niemeyer (2003)

As it can be seen in Figures 5.17 and 5.18, both methodologies have structures consisting of limited amount of steps. Although Niemeyer (2003) proposes steps for further conceptual design and in more detail by including risk analysis, more detailed evaluation and configuration of concepts, some similarities can be observed.

One of the main differences is that the 'demand-solution' approach works with a predefined number of solutions, mostly because it is possible to do it when restrictions concerning type of structure and length are included. The 'Five-step' methodology on the other hand is more versatile and is developed for buildings in general. It describes the open problem more, but does not provide so much predefined help, i.e. all the decisions are relying on the designers. On the contrary, the narrowed scope of the 'demand-solution' approach allows for investigating and finding relations between various design situations and solutions. It can be argued that the 'demand-solution' methodology removes the 'creative' part of conceptual design. However, due to the conservatism of the building industry and its strong influence in mainstream bridges (where short spans are predominant), this approach is logical. Even though the bridge types are predefined, small details can always lead to 'new' developed solutions. The problem is further tackled with the presence of innovative bridge types as well as the flexibility of the toolbox, which allows for further additions.

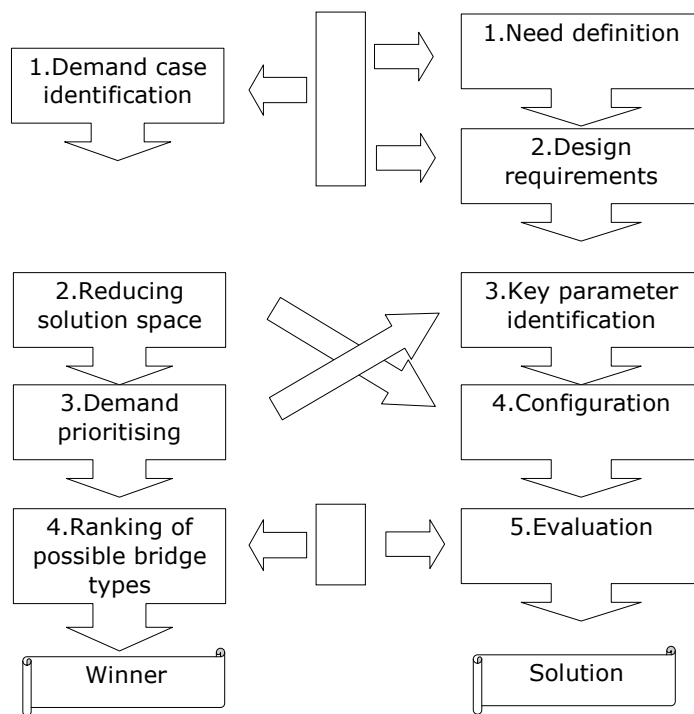

Figure 5.19 shows the following similarities:

- The 'Demand case identification' combines 'Need identification' and 'Design requirements' in one step. This is possible because the type of structure for the 'demand-solution' approach is known (short-span bridge), while Niemyer's problem can be of any type.
- 'Demand prioritising' and 'Key parameter identification' achieve the same effect – extract the real demands and important aspects for the client.
- 'Ranking of possible bridge types' and 'Evaluation' are dealing with final evaluation of the proposals and pointing out the most suitable solution (bridge type).

6 Case studies

In this chapter it is described how the methodology proposed in Chapter 5 was implemented in two selected case studies. The main goal of the case study was to apply the proposed conceptual design procedure in real design situations and compare the outcomes with the actual decision made previously by Ramböll's engineers.

In order to get a more qualitative result instead of quantitative, the proposed design approach was applied by two different conceptual design engineers to the same bridge project (case study 1). This can show the subjective nature of design and the differences it leads to. A second case study was done with another office of Ramböll – the one in Stockholm. The choice of projects intended to cover the biggest variety in conditions and design situations. Although both projects concern road traffic, one of them is a replacement and the other is a new bridge. Moreover, the obstacles are quite different (river and a railway line).

6.1 The Backaå bridge

6.1.1 Background

This project concerns replacement of an existing road bridge over a small spring (river) called Backaå located in the countryside of southern Sweden (Figure 6.1). It is an old single spanning stone arch bridge and the existing road is perpendicular to the river. Consisting of one lane in each direction it served the local community. The soil on the site was mainly sandy with rock surface at 4-10 m depth.



Figure 6.1 The Backaå bridge (Ramböll)

The main reason for demanding a change or improvement of the existing bridge was its restriction with regard to the heaviest type of vehicles, i.e. to meet the newest requirements. The Swedish Transport Administration decided to improve this and then the task was given to Ramböll's engineers. After initial discussions about a strengthening of the existing stone arch bridge, it was realised that there is no need to preserve it. Neither it was a historical structure, nor did the client stress this out. Since strengthening of the existing bridge would have been very costly and unnecessary, it was decided to completely remove the old structure and erect a new bridge.

Three persons were interviewed for the project – two conceptual design engineers who have worked with it and the structural engineer responsible for the detailed

design. The proposed toolbox was used with the first two persons, while an interview with the structural engineer aimed to receive another point of view and experience from the later stages of design. In a way this feedback is reflecting the quality of the work in the conceptual design phase. Even though slight changes were made in the tool box between the two studies, due to continuous improvement, there was not a significant effect on the results.

6.1.2 Input and results

In this section a short summary of the input and explanation of choices are described. The Step 1 input for both conceptual engineers was identical, therefore it is presented together. If there was difference in answers, it is commented accordingly. Hereafter the following abbreviations are used:

Conceptual designer 1 – **C1**

Conceptual designer 2 – **C2**

Structural engineer – **D**

1. What type of traffic is the bridge designed for?

- Road traffic and/or fauna

2. What type of obstacle does the bridge need to cross?

- Water – a stream

3. What are the predominant ground conditions?

- Frictional material – sandy soil

4. What is the expected (provisional) length of the bridge?

- Both stated 7 meters. This was an easy choice, which was determined by the abutments of the old bridge.

5. Can construction work be done in the obstacle area?

- Yes, with limited restrictions or problems – by C2.
- No – by C1

Comments: The difference in the answers is due to the different timeline input during the case study. With the project already finished, both designers knew the final situation in detail. However, at early stages it was thought that work in water would be possible. This is reflected by C2 as he tried to answer the questions without using his knowledge from later stages of the project. On the other hand, C1 considered his knowledge from the later stage.

6. Is construction time of major concern (crucial importance)?

- No

Comments: Both answered 'No' even though the road had to be closed for a period of time. This shows that definition of 'time' is very unclear and imprecise. C1 explained that the client wanted to change the bridge during the summer.

7. Is this a new road/railway for the traffic (no bridge already exists)?

- No

8. Is there a possibility to place a middle support in the obstacle area?

- No

9. What is the needed bridge shape (in the horizontal plane)?

- Straight – due to the existing profile of the road.

10. What is the needed position in the vertical plane?

- Horizontal

11. Other special requirements.

12. Where is the bridge situated?

- Countryside – a bridge outside living areas, mostly on intercity roads or railways

13. What is the needed width of the bridge or how many lanes/lines are needed?

- (2-3) lanes/lines

The feedback and comments from the two users of the toolbox can be found in Appendix C. A few general remarks by the users and authors are presented below:

- The design approach with the toolbox is interesting as it could raise important questions during the meetings with the client and be used as a tool to argue for certain concepts.
- Input of length is difficult, due to various possibilities for the level of the bridge and the interdependence of length and the structural system. In the case study itself this was not an issue as the level of the road existed.
- It is very difficult to grade (evaluate) concepts if the designer is not familiar with them (composite bridge types).
- The final scores in two or three digits were not very guiding, see Figure 6.3. A division by 100 would fix this issue. For example, a result of '212' would be '2.12' meaning a little above 'adequate'.

Solution space																				
1	2	3	4	5	6	7		9	10	11	12	13	14	15	16	17	18	19		
1	2	3	4	5	6	7	8	9	10	11	12	13	14	15	16	17	18	19		
1	2	3	4	5	6	7		9	10	11	12	13	14	15	16	17	18	19		
1	2	3	4	5				9						15					20	21
1	2	3	4	5				9						15					20	21
1	2	3	4	5				9	10	11	12	13		15	16	17	18	19		
1	2	3	4	5			8	9	10	11	12	13		15	16	17	18	19		
1	2	3	4	5				9						15					20	21
1	2		4	5	6	7		9	10	11	12	13	14	15	16	17	18	19		
1	2		4	5	6	7	8	9	10	11	12	13	14	15	16	17	18	19		
1	2		4	5	6	7		9	10	11	12	13	14	15	16	17	18	19		
1	2	3	4	5				9	10	11	12	13		15	16	17	18	19		
1	2	3	4	5	6	7		9	10	11	12	13	14	15	16	17	18	19		

Figure 6.2 Solution space left after reductions

Bridge types, which were excluded by the toolbox, are high lightened in Figure 6.2. This means that they are considered inappropriate for the present situation. The following bridge concepts remained (for more information about the bridge types, see Chapter 4):

1. Slab-frame cast in-situ concrete – in this case it is not a feasible solution. Neither it is fast to accomplish, nor can it be launched from the side. C2 excluded it in the subjective reduction. C1 kept it probably without assessing it consciously.
4. Simply supported cast in-situ concrete slab – considered possible even though it requires formwork. Due to the short span (7m) it is feasible to accomplish.
6. Pre cast hollow core elements – reasonable concept.
9. Corrugated steel arch – proposed for exclusion but not deleted by the toolbox C1 excluded it because of inability to work in water. However, C2 decided to keep it as an option.
10. Stress-laminated timber plate - reasonable and likely solution.
17. Steel ‘I’ girders and FRP composite deck – could be possible and effective for this span length. But possibly up to 3 times more expensive than a concrete deck.
19. ‘Folded plate system’ – for this situation it seems quite reasonable for using this concept. However, both of the designers excluded it subjectively.

Hint: Put a grade from (0÷4) to each parameter for each alternative. Here grade 4 is the highest possible.

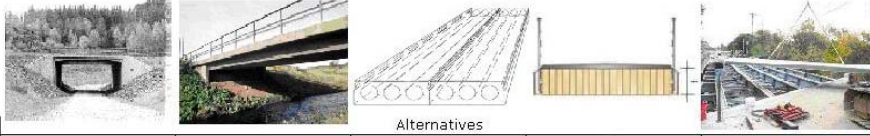

D E M A N D S		Flexible	Weighting coefficient	Alternatives									
				1		4		6		10		17	
				Slab frame in-situ		Simply supported slab in-s		Prefab. hollow core		Stress-laminated plate		Steel I-girders and FRP de	
		Grade	Points	Grade	Points	Grade	Points	Grade	Points	Grade	Points		
F i x e e d	Aesthetical design	6,0	2	12,0	2	12,0	1	6,0	3	18,0	2	12,0	
	Service life	18,0	3	54,0	2	36,0	2	36,0	2	12,0	2	36,0	
	Environmental	6,0	1	6,0	1	6,0	2	12,0	3	18,0	2	12,0	
	Performance	35,0	3	105,0	3	105,0	2	70,0	2	70,0	2	70,0	
	Structural design	14,0	1	14,0	1	14,0	2	28,0	3	42,0	3	42,0	
	Production	21,0	1	21,0	1	21,0	1	21,0	2	42,0	1	21,0	
Final grade			212		194		173		202		193		

Hint: Put a grade from (0÷4) to each parameter for each alternative. Here grade 4 is the highest possible.



D E M A N D S		Flexible	Weighting coefficient	Alternatives									
				4		6		9		10		17	
				Simply supported slab in-s		Prefab. hollow core		Corrugated steel arch		Stress-laminated plate		Steel I-girders and FRP de	
		Grade	Points	Grade	Points	Grade	Points	Grade	Points	Grade	Points		
F i x e e d	Aesthetical design	10,0	3	30,0	1	10,0	3	30,0	3	30,0	3	30,0	
	Service life	25,0	3	75,0	1	25,0	4	100,0	4	100,0	2	50,0	
	Environmental	15,0	2	30,0	3	45,0	3	45,0	3	45,0	3	45,0	
	Performance	20,0	4	80,0	2	40,0	4	80,0	4	80,0	3	60,0	
	Structural design	10,0	3	30,0	2	20,0	3	30,0	3	30,0	2	20,0	
	Production	20,0	2	40,0	3	60,0	4	80,0	3	60,0	2	40,0	
Final grade			285		200		365		345		245		

Figure 6.3 Final results for case study 1 – C1 (above) and C2 (below). The ‘prioritising of demands’ is depicted in the ‘weighting coefficient’ column.

First of all, ‘prioritising of demands’ is reflected in the ‘weighting coefficient’ column in Figure 6.3. Both users used the ‘quick ranking matrix’ (acc. Figure 5.16). Even though both designers gave similar importance to ‘Production’, most of the values differed. Important variation was identified when comparing the ratios between ‘flexible’ and ‘fixed’ parameters. While C1 decided to give strong preference to ‘fixed’ (70/30 for fixed/flexible), C2 kept them as equally important. Although the spread of values between the demand parameters in Figures 5.8 and 5.9 is similar, the above mentioned ratio of fixed/flexible parameters has changed the final weights significantly.

If the grades given are compared some conclusions can be drawn. User C1 has put lower grades in average with several ‘1’ (Just tolerable) and not a single ‘4’ (ideal). On the other hand, C2 has used higher scores including ‘4’. This difference is assumed to be mostly due to the more positive attitude of user C2 and his longer

experience compared to C1. Considering these differences, it was assumed that applying the same approach to all solutions would not affect the final result (C2 giving mostly higher and C1 giving mostly lower grades).

Here below, the most appropriate concepts proposed by the toolbox are discussed.

Conceptual designer 1 (C1):

The guidelines proposed a slab-frame (Section 4.1.1) solution as the most appropriate. As it can be seen from Figure 6.3 above, it receives most of its advantages because of high grade for 'performance'. A flaw of the automated exclusion (Table 5.6) mentioned earlier was discovered. Even though the user answered that the obstacle is a water source and there is space for construction in the area but with restrictions, the toolbox did not exclude the slab-frame option. Obviously this bridge type is inappropriate for the current case and must be disregarded. That makes the stress-laminated timber plate the most suitable proposal, which got the second best score.

Conceptual designer 2 (C2):

According to the input by C2, the corrugated steel arch got the highest score, mostly because superior durability and service life qualities in combination with very easy construction. However, in the real case it would have been inappropriate to accomplish due to present high water levels. C2 kept this option on the basis of earlier data and not considering the later knowledge about the inability to work in water. If then we disregard the corrugated arch alternative, the second highest score was obtained by the stress-laminated timber plate. For more detailed pictures look at Appendix D.

6.1.3 Comparison with the real case

The first proposal Ramböll came with was to implement the corrugated steel arch solution (Section 4.2.1). However, later on it was disregarded due to inability to work in water and high water level present. The main focus of the client in this project was cost and good durability. Moreover, the designer stated that the ground conditions in this case were favourable. A low significance was given to construction complexity and structural design as the geometrical situation was simple with straight bridge and abutments.

The final solution proposed was a stress-laminated timber slab bridge. The main reasons for this choice were fast erection and cheap cost for the span.

6.2 The Bräcke bridge

6.2.1 Background

The project in focus was a new road bridge over an existing railway track in the province Jämtland in the north of Sweden. The road profile was already decided beforehand, so the geometry of the bridge had to follow it (Figure 6.4). This meant that the solution must be in a slight horizontal curve and vertically curved. One important aspect was a decision to make the distance between the abutments and the middle of the rail at least 10 m. According to the Swedish codes, this eliminates the

need to design the bridge with regard for accidental loads. This led to a need of a construction of parallel abutments to the railway line. The soil on the site was mainly silty moraine.

The contract was more similar to ‘Total contract’ as a contractor was hired to design and build the bridge. Then, the contractor commissioned Ramböll for the design. Even though the contractor had significant freedom and demanded a certain way of production (rolling reinforcement, optimisation of the construction height etc.), The Swedish Transport Administration had put a lot of fixed demands and requirements beforehand.

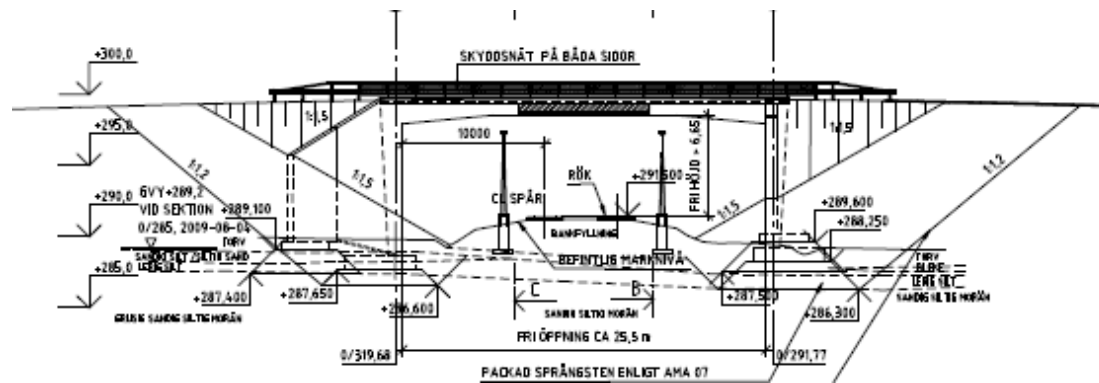

Figure 6.4 The actual situation (though it includes the solution) (from Ramböll)

6.2.2 Input and results

A short summary of the input and explanations of choices are presented below. The conceptual design engineer is called ‘C3’.

1. **What type of traffic is the bridge designed for?**
 - Road traffic and/or fauna
2. **What type of obstacle does the bridge need to cross?**
 - Railway
3. **What are the predominant ground conditions?**
 - Frictional material – silty sandy moraine soil
4. **What is the expected (provisional) length of the bridge?**
 - 25 meters.
5. **Can construction work be carried out in the obstacle area?**
 - Yes

Comments: Even though it was a running railway track, the designers thought of a method, which allows working in the obstacle area. It consists of a special formwork tunnel around the line and a regular at the rest of the length. Railway traffic had to be

stopped, but only for a short period. According to the authors, answering ‘Yes with limited restrictions’ would represent the case better.

6. Is construction time of major concern (crucial importance)?

- No

Comments: The user decided to choose ‘No’ as the client has not stressed this out.

7. Is this a new road/railway for the traffic (no bridge already exists)?

- Yes

8. Is there a possibility to place middle support in the obstacle area?

- No

Comments: It is absolutely impossible to place a middle support, due to the railway track and the desire to avoid risks of accidental collision.

9. What is the needed bridge shape (in the horizontal plane)?

- In a curve

Comments: The user hesitated between curved and skew options. This was because the abutments were skew, but the shape was curved. As mentioned above, the road planner already had decided the horizontal layout of the bridge and the conceptual designer did not have freedom in that sense.

10. What is the needed position in the vertical plane?

- Vertically curved

Comments: Though only a very big radius was needed, curved bridge was selected.

11. Other special requirements.

Comments: There was a requirement from the client to provide concrete surface layer instead of the common asphalt. This was mainly due to local traditions and also with regard to reduced environmental impact when maintaining the bridge (concrete needs only top layer change, while asphalt requires more serious repairs).

12. Where is the bridge situated?

- Countryside

13. What is the needed width of the bridge or how many lanes/lines are needed?

- (2-3) lanes/lines

The feedback and comments from the user on the toolbox can be seen in Appendix C. Some more general remarks are presented below:

During ‘prioritising of demands’, some interesting points have been discussed. If the designer follows strictly Vägverket (2004) (TK Bro code), it will turn out that all solutions are good enough. It was developed in such a way so that it covers all the minimum requirements. The code does not cover only architectural aspects. With the introduction of Eurocodes, both are supplementing each other: while Eurocodes are describing the detailed design, Vägverket (2004) (TK Bro code) covers all other parts (conceptual design, maintenance, construction, detailing, and other aspects) except design. For the Swedish Transport Administration as a client it is mostly appropriate that the bridge is ‘good enough’ rather than ‘better’. However, the final decision depends always on the initial total cost.

Solution space																				
1	2	3	4	5	6	7			10	11	12	13	14	15	16	17	18	19		
1	2	3	4	5	6	7	8	9	10	11	12	13	14	15	16	17	18	19		
1	2	3	4	5	6	7		9	10	11	12	13	14	15	16	17	18	19		
1	2	3	4	5				9						15					20	21
1	2	3	4	5										15					20	21
1	2	3	4	5					10	11	12	13		15	16	17	18	19		
1	2	3	4	5				9	10	11	12	13		15	16	17	18	19		
1	2	3	4	5				9						15					20	21
1	2		4	5	6	7			10	11	12	13	14	15	16	17	18	19		
1	2		4	5	6	7	8	9	10	11	12	13	14	15	16	17	18	19		
1	2		4	5	6	7		9	10	11	12	13	14	15	16	17	18	19		
1	2	3	4	5				9	10	11	12	13		15	16	17	18	19		
1	2	3	4	5	6	7		9	10	11	12	13	14	15	16	17	18	19		

Figure 6.5 Solution space after the first two exclusions

The following bridge types from Figure 6.5 are left and are discussed below:

1. Slab-frame cast in-situ bridge – a very natural choice in case formwork is possible.
2. Beam-frame cast in-situ – reasonable option, though the horizontal and vertical curves could increase the cost and cause some difficulties.
3. Integral abutments – questionable alternative due to the required curved shape and possible problems with the piling.
4. Simply supported slab cast in-situ – considered as possible even though it might have high self-weight due the long span (25m). Moreover, the horizontal curve will introduce torsional moments, which have to be accounted for.

5. Simply supported beam cast in-situ – a good solution especially concerning the torsional stiffness.

15. Composite bridge with steel girders and cast in-situ deck – a possible alternative

16. Composite bridge with steel girders and pre cast deck elements – a possible alternative though production of curved elements would probably be very expensive.

During the final subjective reduction, the designer decided to exclude solutions 15 and 16, mainly due to their higher costs for the actual span. He stated that if the span was about 35 meters, these solutions would have been very competitive alternatives. Moreover, all the excluded solutions were also evaluated and the designer agreed that their elimination was reasonable. The beam solutions (2 and 5) were described as being much more expensive due to the complicated formwork needed. This is reflected in the grading below, see Figure 6.6.

D E M A N D S		Alternatives											
		1		2		3		4		5			
Flexible		Slab frame in-situ		Beam-frame in-situ		Integral abutments		Simply supported slab in-situ		Simply supported beam in-s			
		Grade	Points	Grade	Points	Grade	Points	Grade	Points	Grade	Points		
Aesthetical design		4	0,20	4	0,20	4	0,20	3	0,15	3	0,15		
Service life added values		4	1,20	4	1,20	4	1,20	4	0,20	4	1,20		
Environmental issues		3	0,45	3	0,45	3	0,45	3	0,45	3	0,45		
Performance		4	1,20	4	1,20	2	0,60	4	1,20	4	1,20		
Structural design		4	0,20	3	0,15	2	0,10	3	0,15	3	0,15		
Production		3	0,45	2	0,30	4	0,60	3	0,45	2	0,30		
Final grade		3,70		3,50		3,15		2,60		3,45			
Weighting coefficient		0,050		0,300		0,150		0,050		0,150			



Figure 6.6 Final results for case study two

According to the input from the designer during the conceptual design process and at its last step - 'ranking of possible bridge types', the most appropriate suggestion would be to construct the slab-frame bridge. If the proposed temporary formwork is

chosen, this alternative seems quite appropriate due to the relatively low cost and good durability.

6.2.3 Comparison with the real case

The designers chose a slab-frame bridge, see Figure 6.7. They stated that this option was a very natural choice bearing in mind the length of the span and the favourable ground conditions. Moreover, the simply supported slab cast in-situ was considered an alternative.

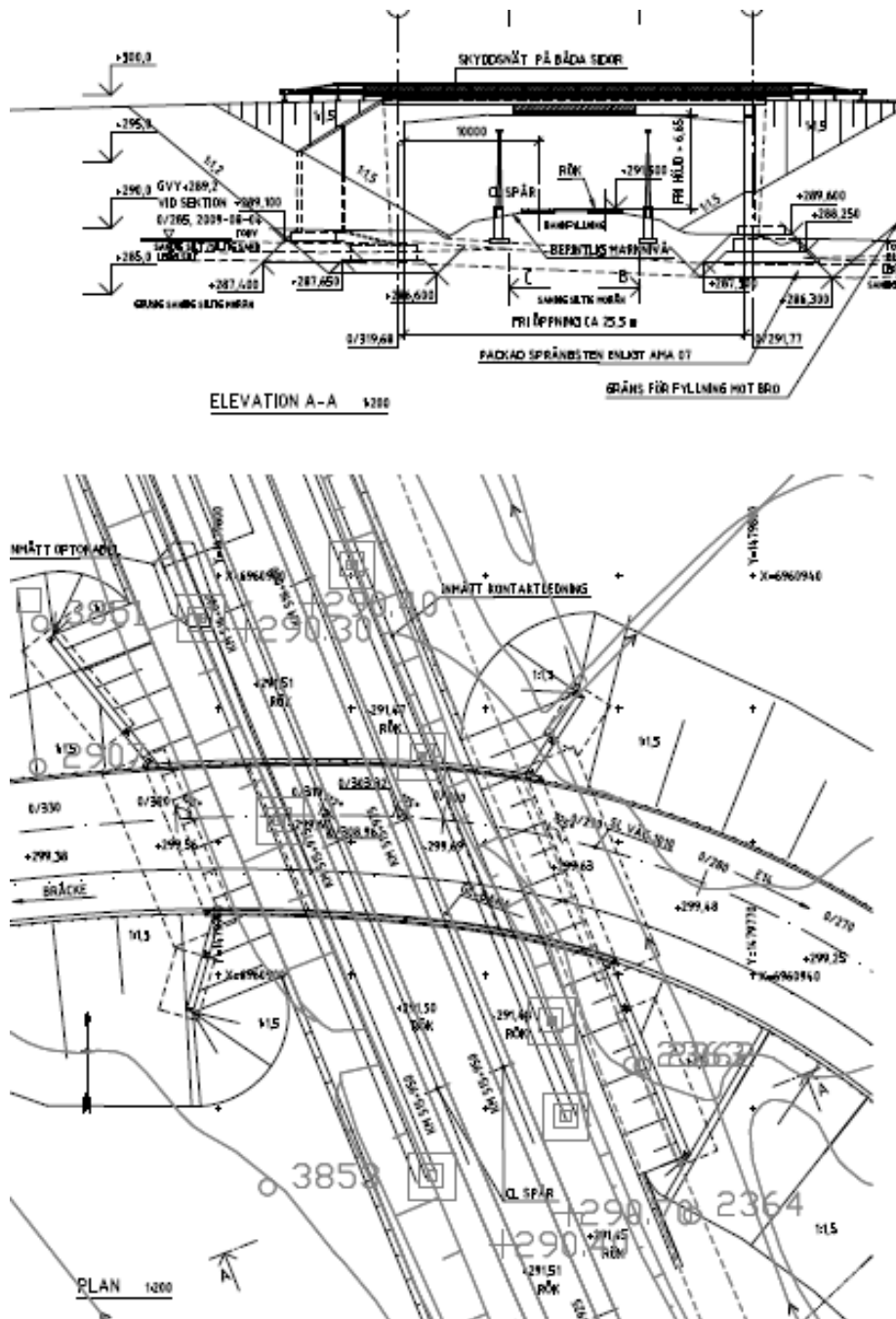

Figure 6.7 Real solution by Ramböll

6.2.4 Critical remarks

Even though the designer was very experienced and well-known among his colleagues in Sweden, some criticism could be given. The effect of maybe too much experience was observed – only one solution was considered from the very beginning without exploring other alternatives. Moreover, due to traditions, he thought that timber bridges are not a good alternative for road bridges. The same opinion was expressed for precast beam elements. As a result, this meant that he considered almost exclusively cast in-situ concrete solutions for short-span bridges. Another point when grading the solutions was the possible unconscious preference towards the chosen (and real case) concept.

6.3 Conclusions

The goals of the case study were met – to test the toolbox with its guidelines on real cases and compare the results with the real solutions proposed by Ramböll's consultants. All the feedback concerning the interface and methodologies was implemented to improve the toolbox. Some flaws, such as not excluding some solutions in certain situations were removed or reconsidered. On the other hand, all solutions that were left as possible were reasonable options. Adjustments to the span length ranges were also made.

If the final results for both of the conceptual designers (C1 and C2) in the first case study are analysed and the flaws taken into account, it can be observed that the concepts are matching (stress-laminated timber plate). Even though the proposals are the same, one cannot prove that this solution is the best one. Criticism should be given to reach the best iteration. For the second case study, the results matched exactly.

The biggest problem in conceptual design was observed during the interviews related to the case studies – shortage of time. Indeed, the users were always in a hurry and they did not have very much time to complete the toolbox. Probably this will be the situation for real projects as well. However, if they use the Excel toolbox a couple of times, it should prove itself as a very helpful tool.

In conclusion, the design approach supported by the toolbox worked rather well both in terms of results and interface. The users were satisfied and proposed improvements. These changes and improvements of the methodology based on the case studies are already reflected in Chapter 5, i.e. the final version of the toolbox was prepared considering the received feedback.

7 Conclusion

7.1 Concluding remarks

During this thesis project it became clear that the task to place conceptual design within certain frames and fixed rules is very complex. The designer has to consider many variables of which most are unknown in the early stages of a project. However, by limiting the scope to short-span bridges for road or railway traffic, this difficult task is easier to handle. It was discovered that the more options (demand cases, solutions) exist, the better the accuracy of the design approach is.

Some lessons learned during the project are summarised below:

- Acquiring the knowledge about which solutions are most appropriate in which design case considering the answers of where, when and why, is very subjective and difficult to accomplish.
- The attempt to identify the relation and link between demand cases and solutions was the most unclear and complex to implement.
- Conceptual design is a multidisciplinary task requiring a holistic approach and understanding of all the stages of design. Good collaboration and dialogue between various specialists is crucial.
- Lack of time for conceptual design is the biggest problem designers are facing in practice.

The developed step-by-step guideline, which is embodied in an Excel file, has the following **advantages**:

- It is a structured way to approach conceptual design.
- It provides additional value by storing the decisions made and providing information about the logic behind them (documentation).
- Changes in the semi-automated Excel toolbox can be done fast and on the spot.
- Versatility – the proposed toolbox covers as many different situations as possible.
- Flexibility – the whole design procedure with its toolbox is prepared in a way that it could be further developed and expanded later (longer spans; pedestrian bridges). It allows for further improvements such as adding new solutions, changing the contents and fixed parameters.

The **disadvantages** of the methodology are described below:

- Limitations in terms of length of the bridge (30 meters).
- Difficulty to evaluate and compare the importance of demand parameters from Section 5.2.3 (demand prioritising) to each other.
- It could be deceptive for young engineers if they rely too much on it; time is needed to get used to work with the guidelines.
- It does not cover the whole conceptual design process, since it does not go so much into detail.

7.2 Further development

The limitations presented in Section 5.1 could be reduced or completely removed after further work on the topic. Some of the following areas for improvement and further work are proposed by the authors:

- Refine the quality of the data such as span ranges and suitability of solutions in different situations. Moreover, evaluation of the proposed solutions and possibilities to include more options is advised.
- Improve the way how continuous bridges are considered.
- Increase the length limit present (30 meters). However, this has to be done with careful evaluation of the possible consequences. The authors are not confident enough whether the current approach could be used or it would need major editing.
- Include pedestrian bridges. The authors are not recommending this as it will limit the creativity and engineering art in these special types of bridges.

References

- Allen, C. et al. (2008): *Integrated abutments bridge design guidelines ;*), 2nd edition
Montpelier, Vermont
- Asphage, Cl.(2009) *Integral Abutments on Bridges with Timber Deck*. Master's
Thesis. Department of Structural Engineering, Chalmers University of Technology,
Publication no. 2009:60, Göteborg, Sweden, 2009.
- Banverket (2007): *Broprojektering - handbok BVH 583.20*
- Collin, P. Hällmark R. (2006): *Innovative Prefabricated Composite Bridges*
- Collin, P. Lundmark T. (2002): *Competitive Swedish Composite Bridges*. IABSE
Symposium, Melbourne, 2002.
- Dekker, K., (2000): *Conceptual Design of Concrete Structures*. Master's Thesis.
Department of Structural Engineering, Chalmers University of Technology,
Publication no. 00:4, Göteborg, Sweden, 2000.
- Ehlorsson, V; Palmqvist, V. (2010): *Prefabricerade betongbroar- är det möjligt?*
Bachelor's Thesis. Högskolan Halmstad.
- Engström, Björn (2002): *SS-intuitive phase_10.pdf*. Structural systems course,
Chalmers University of Technology
- Engström, Dan (2009): *Conceptual Engineering.pdf*. Structural systems course,
Chalmers University of Technology
- ESDEP Lecture Note 15B
- ESDEP Lecture Note WG1B
- fib (2000): *Guidance for a good bridge design*, bulletin 9, part 1 and 2. Lausanne,
Switzerland, 2000
- fib (2010): *Model code 2010, first complete draft*, bulletin 55, vol. 1
- Flyvbjerg et al. (2002): *Underestimating Costs in Public Works Projects: Error or
lie?* Journal of the American Planning Association (Chicago: American Planning
Association) 68 (3): 279–295. ISSN 0194-4363.
- Gottemoeller, Fr. (2004): *Bridgescape: the art of designing bridges*. 2nd edition, New
Jersey, USA. John Wiley & Sons Inc. ISBN 0-471-26773-2
- Harryson, P. (2002): *Industrial bridge construction: merging developments of
process, productivity and products with technical solutions*. Doctoral Thesis.
Department of Structural Engineering, Chalmers University of Technology,
Publication no. 02:1, Göteborg, Sweden, 2002.
- Kroll, Ehud (2001): *Innovative conceptual design*. Cambridge University press 2001.

Leonhardt, Fr. (1990): *Bridges*. Deutsche Verlags-Anstalt GmbH, Stuttgart (1990), ISBN 3-421-02590-8

Lövqvist, P. (1994): *Knowledge-based systems for preliminary design of structures*. Doctoral Thesis. Department of Structural Engineering, Chalmers University of Technology, Publication no. 1994:1, Göteborg, Sweden, 1994.

Niemeyer, S., (2003): *Conceptual Design in Building industry*. Master's Thesis. Department of Structural Engineering, Chalmers University of Technology, Publication no. 03:6, Göteborg, Sweden, 2003.

Paul and Beitz (1996): *Engineering design: a systematic approach*.

Tosi, M., (2010): *Process from a conceptual design to a structural solution for a timber bridge*. Master's Thesis. Department of Structural Engineering, Chalmers University of Technology, Publication no. 2010:78, Göteborg, Sweden, 2010.

Träinformation (1996): *Träbroar: ett alternativ till stål och betong*.

Vägverket (1996): *Broprojektering-en handbook* Publication 1996:63

Vägverket (1997): *Vackrare väg- Arkitektoniska kvalitetsfrågor i vägholningen*. Publication 1997:88

Vägverket (1999): *Vägar – Kvalitetsprogram för vägarkitektur*. Publication 1999:102

Vägverket (2004): *BRO 2004*. Publication 2004:56

Vägverket (2006): *Vägen. En bok om vägarkitektur*. Publication 2006:28

Vägverket (2009): *TK Bro*. Publication 2009:27

Vasant, C.M.(2000):*Internal abutment and jointless bridges*

Internet sources:

Abetong, Web page, <http://www.heidelbergcement.com/dk/da/perstrup/tunneler>, accessed on (06-03-2011).

BAMTEC System, Bamtec Web page, http://www.bamtec.com/Bamtec_en/Bamtec_System.htm, accessed on (01-03-2011).

BaTMan (2011), <https://batman.vv.se>, accessed on (15-03-2011).

Composite Advantage (2011), Web page, www.compositeddvanantage.com, accessed on (12-03-2011).

Highway Bridge Services, Web page, <http://foldedplate.com/testing/index.html>

Image from Google maps, Web page, <http://www.maps.google.com>, accessed on (01-03-2011).

Martinsons, Web page, <http://www.martinsons.se/trabroar>, accessed on (10-03-2011).

Matiere, Web page, <http://www.matiere.fr/english/>; accessed on (06-03-2011).

Miebach Ingenieurburo, Web page, <http://www.ib-miebach.de/>, accessed on (17-03-2011).













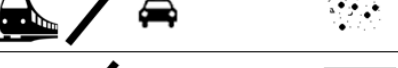
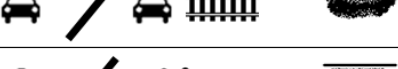

National Composites Network, Web page, <http://www.ncn-uk.co.uk>, accessed on (16-03-2011).

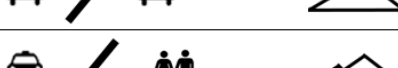
Precast bridges, Hollow core concrete pty Ltd. Web page
<http://www.hollowcore.com.au/content/view/15/33/>, accessed on (06-03-2011).

Träguiden, Web page, www.traguiden.se, accessed on (10-03-2011).

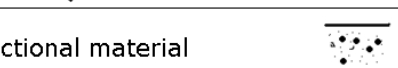
Appendix A: Description of the toolbox

Table 7.1 Demand cases

Case	Description	Visualisation
1	Road bridge over railway or road	
2	Road bridge over pedestrian passage	
3	Road bridge over water	
4	Railway bridge over water	
5	Railway bridge over Road	
6	Road bridge over railway or road	
7	Road bridge over pedestrian passage	
8	Railway bridge over water	
9	Road bridge over railway or road	
10	Road bridge over pedestrian passage	
11	Road bridge over water	
12	Road bridge over water+fauna	
13	Road bridge over water+fauna	
		Frictional material 
		Clay (or cohes. soil) 
		Rock 

Input questionnaire - main menu

Note: Put the mouse on the questions to see clarifications

General entrepreneurship:

Question	Comments from user:	Explanation and comments:	Disregard (exclude) solution if it is not excluded beforehand...
<p>1. What type of traffic is the bridge designed for? Type of traffic?</p> <p><input checked="" type="radio"/> Road traffic and/or fauna <input type="radio"/> Railway traffic</p>		<p>Input the main type of traffic for the bridge. Pedestrian bridges are disregarded in this version but pedestrian lane on a road or railway bridge is included.</p> <p>If a combination is present, choose the answer closest to reality. Try to focus on the main obstacle (causing biggest demands and requirements). Observe that pedestrian passage means a pedestrian tunnel under a road or railway.</p>	<p>Road Railway</p>
<p>2. What type of obstacle the bridge needs to cross? Type of obstacle?</p> <p><input checked="" type="radio"/> Water <input type="radio"/> Road and/or railway <input type="radio"/> Pedestrian and/or cycle passage <input type="radio"/> Fauna and water</p>		<p>Please specify the predominant ground conditions. If it is understandable that there is this layer of bad soil and it can be removed easily, then mark the soil beneath it.</p>	<p>OK OK</p>
<p>3. What are the predominant ground conditions? Ground conditions?</p> <p><input type="radio"/> Clay or cohesive soil <input type="radio"/> Rock <input checked="" type="radio"/> Frictional material</p>			<p>OK OK</p>
<p>4. What is the expected (provisional) length of the bridge? Note: enter a number with ± 1 m margin</p>	<p>12.0</p> <p>Link to graphics</p>	<p>Input the provisional length of the bridge. The user is advised to use the methodology twice if there are span ranges or span depends on the solution.</p>	<p>Reduction 2</p> <p>OK 2 OK OK 5 6 OK 8 9 OK OK OK 13 14 15 16 OK OK OK OK OK OK 5 9 15 OK OK</p>
<p>5. Can construction work be done in the obstacle's area?</p> <p><input checked="" type="radio"/> Yes <input type="radio"/> Yes, with limited restriction or problems <input type="radio"/> No</p>		<p>Concerns local site conditions - difficult geometry or highly irregular terrain. The user can mark the obstacle area, or road can work there to stop the traffic. These restrictions or problems are not severe and can be solved with little resources, time, money, machinery/stop of traffic.</p>	<p>OK OK</p>
<p>6. Is construction time of major concern?</p> <p><input checked="" type="radio"/> Yes <input type="radio"/> No</p>		<p>Has the client stressed time as his priority or is it understandable by default for the project? Is there an express need of the bridge or if the construction will stop some traffic, reduce traffic capacity or other processes. For example, causing big changes in logistics or financial loss.</p>	<p>2,3,4,5</p>
<p>7. Is it a new road/railway for the traffic (no current bridge exists)?</p> <p><input checked="" type="radio"/> Yes <input type="radio"/> No</p>		<p>Is the project for a completely new road or railway? If the road/rail exists and traffic is running and will be running, then it is a replacement of bridge (or deck). In this case choose 'No'. Remember that the questions concerns the traffic and not the obstacle.</p>	<p>OK</p>
<p>8. Is there a possibility to place middle support in the obstacle's area?</p> <p><input checked="" type="radio"/> Yes <input type="radio"/> No</p>		<p>Clarifies whether a support can be placed or it is suitable to place. For instance, can it be placed in water or in the middle of a two-lane road.</p>	<p>OK</p>

Figure 7.1 Input questionnaire, part 1

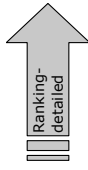

9. What is the needed bridge shape (in the horizontal plane)?

Straight
 Skewed (at an angle)
 In a curve

10. Does the bridge need to be...?

Horizontal or inclined
 Vertically curved

11. Other special requirements

		3	If there is a requirement from the landscape architect or the client. Could be also requested due to the local geometrical conditions.
		2	If there is a requirement from the landscape architect or the client.
			Please write down any other requirements or demands for the project. Some special circumstances can be added as well

Ranking-detailed: 6,7,8,9,10,11,12,13,14,16,17,18,19

OK

7,10,19

12. Where is the bridge situated?

Bridge location

Urban area
 Highway area
 Countryside

13. What is the needed width of the bridge or how many lanes/lines are needed?

Width of bridge?

single lane/line
 (2-3) lanes/lines
 4 lanes/lanes or more

CONTINUE

Questions for documentation:

1	Urban; city or very populated area Highway (suburban): around a highway region or in the outskirts of city or industrial area with little citizens Countryside: a bridge outside living areas, mostly on intercity roads or railways
2	

Ranking-detailed: 10?,11?,12?,13?,14?,18?

OK

14. Timber fits difficulty in urban environment

Ranking-detailed: 10,11,12,13,14,16,17,18,19

OK

15. (optional)

Figure 7.2 Input questionnaire, part 2

Prioritizing of demands - 'objective tree'

Hint: Give a grade in terms of percentage to each of the parameters according to their importance for the project. Observe that by placing the mouse in cells with comments (red corners), the user can get clarifications. The focus of this table is not to think of money but giving priorities to different values. Thus, the demands and needs of the client can be interpreted more consistently. Values can be always changed if needed later.

Rules:
 The numbers do not have to be very exact, this is approximation.
 Take precaution that all checks (B45-B49) are fulfilled.
 To understand what is meant under each topic (parameter), put the mouse above it to see the comment.
 If you cannot decide upon the distribution, spread the points equally i.e 50/50 or 33/33/34.

How to use the tree:
 1. While discussing with the client, go to "LEVEL 2" and "Flexible parameters" to fill in the highlighted cells how much each parameter is important for the client. Discuss these numbers carefully as they represent his/her demands. After this, fill in "LEVEL 2" and "Fixed parameters". Work now on fixed parameters by giving them values of importance according to your expertise and understanding of the task. The main aim of 'fixed' parameters input is use it later in the ranking to compare **how easy and cheap solution**
 2. After completing step 1. and understanding the task and the project deeper, evaluate how important are flexible parameters to the client and describe this with value in the highlighted cell (H30). Observe that the sum of flexible and fixed will be 100.
 3. Check all the values and their reasoning.
 4. If you need fast evaluation, click on the button Quick ranking
 5. If detailed evaluation of the alternatives is needed, click this button Detailed ranking
 6. If detailed is needed continue to the next step.

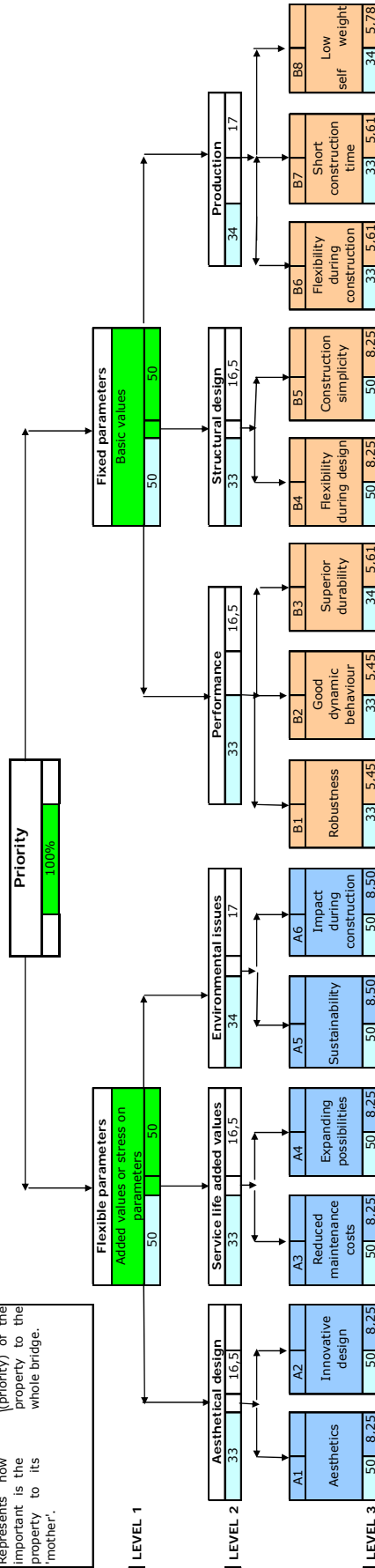
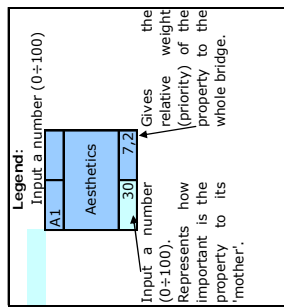

Checks:

Check Sum Level 1:	100	OK
Check Sum Level 2:	100	OK
Check Total Sum:	100	OK
Check Sum Flexible:	100	OK
Check Sum Fixed:	100	OK

Checks:

Check Sum Level 1:	100	OK
Check Sum Level 2:	100	OK
Check Total Sum:	100	OK
Check Sum Flexible:	100	OK
Check Sum Fixed:	100	OK

[BACK](#)

Figure 7.4 'Objective tree'

Case	Description	Visualisation	Code	Status
1	Road bridge over railway or road		A1 B2 C1	FALSE
2	Road bridge over pedestrian passage		A1 B3 C1	FALSE
3	Road bridge over water		A1 B1 C1	OK
4	Railway bridge over water		A3 B1 C1	FALSE
5	Railway bridge over road		A3 B2 C1	FALSE
6	Road bridge over railway or road		A1 B2 C1	FALSE
7	Road bridge over pedestrian passage		A1 B3 C1	FALSE
8	Railway bridge over water		A3 B1 C1	FALSE
9	Road bridge over railway or road		A1 B2 C1	FALSE
10	Road bridge over pedestrian passage		A1 B3 C1	FALSE
11	Road bridge over water		A1 B1 C2	FALSE
12	Road bridge over water+fauna		A1 B4 C2	FALSE
13	Road bridge over water+fauna		A1 B4 C1	FALSE

Demand space

Case	Description	Visualisation	Code	Status
1	Road bridge over railway or road		A1 B2 C1	FALSE
2	Road bridge over pedestrian passage		A1 B3 C1	FALSE
3	Road bridge over water		A1 B1 C1	OK
4	Railway bridge over water		A3 B1 C1	FALSE
5	Railway bridge over road		A3 B2 C1	FALSE
6	Road bridge over railway or road		A1 B2 C1	FALSE
7	Road bridge over pedestrian passage		A1 B3 C1	FALSE
8	Railway bridge over water		A3 B1 C1	FALSE
9	Road bridge over railway or road		A1 B2 C1	FALSE
10	Road bridge over pedestrian passage		A1 B3 C1	FALSE
11	Road bridge over water		A1 B1 C2	FALSE
12	Road bridge over water+fauna		A1 B4 C2	FALSE
13	Road bridge over water+fauna		A1 B4 C1	FALSE

Back to main menu

Solution space

1	2	3	4	5	6	7	10	11	12	13	14	15	16	17	18	19	20	21	
1	2	3	4	5	6	7	9	10	11	12	13	14	15	16	17	18	19		
1	2	3	4	5	6	7	8	9	10	11	12	13	14	15	16	17	18	19	
1	2	3	4	5	6	7	9	10	11	12	13	14	15	16	17	18	19		
1	2	3	4	5			9					15					20	21	
1	2	3	4	5				10	11	12	13	15	16	17	18	19			
1	2	3	4	5			9	10	11	12	13	15	16	17	18	19			
1	2	3	4	5			9					15					20	21	
1	2	3	4	5	6	7	8	9	10	11	12	13	14	15	16	17	18	19	
1	2	3	4	5	6	7	8	9	10	11	12	13	14	15	16	17	18	19	
1	2	3	4	5	6	7	8	9	10	11	12	13	14	15	16	17	18	19	
1	2	3	4	5			9	10	11	12	13	15	16	17	18	19			
1	2	3	4	5			9					15					20	21	

Solutions

	Status from:	Lengths	Vertical curve
1	Slab frame in-situ	OK	OK
2	Beam frame in-situ	Outside	Outside
3	Integral abutments	OK?	OK?
4	Simply supported slab in-situ	OK	OK
5	Simply supported beam in-situ	Outside	Outside
6	Prefab. hollow core	OK?	OK?
7	Prefab. pre-tensioned beams	Outside	Outside
8	Prefab. cast-in-place concrete	Outside	Outside
9	Steel	OK	OK
10	Stress laminated plate	OK	OK?
11	Beam bridge with timber deck	OK	OK?
12	Beam bridge with LVL deck	Outside	Outside
13	Truss bridge	Outside	Outside
14	Timber arch bridge	Outside	Outside
15	Steel truss bridge	Outside	Outside
16	Steel truss bridge with RC deck	Outside	Outside
17	Steel truss bridge with steel deck	OK	OK?
18	Steel truss bridge with FRP deck	OK	OK?
19	Timber truss bridge with FRP deck	OK	OK?
20	Through beam in-situ, flat	-	-
21	Through beam in-situ, ribbed	-	-

How to work:

- After the demand case is identified with 'ok' in the "Demand" table, the "solution space" is given on the right of it. The numbers represent the number of solutions. Click on the "Demand" table to see the details of the solutions, just click on them. If the task does not fall into neither of the "demand" cases, choose the one that is closest to the reality.
- Highlight your demand case for easy navigation.
- Go back to the Input questionnaire (main menu) to input approximate lengths.
- Look in the "Exclude solution" table which options have to go away and mark them red in the solution space. Solution with question mark are proposed for exclusion but the user must decide.
- Look in the table "Solution" and mark all numbers with Status "OK?". Use the "OK" button to get the solution. If very few alternatives are left, it is advisable to consider them as options.
- Analyse all the possible solutions left. If any of them feels inappropriate considering the actual case, remove it.

Reset

Exclude solution:

4	OK	2 OK	OK	5	6 OK	8	9
	OK	OK	OK	13	14	15	16 OK
	OK	OK	OK	5	9	15 OK	OK
5	OK	17,22,37,47,57					
6	2,3,4,5						
7	0	OK					
9	OK						
9	6,7,8,9,10,11,12,13,14,16,17,18,19						
10	7,10,19						
12	107,117,127,137,147,167						
13	OK						

Excluded in Question

Only for railway

Reset

CONTINUE

Your case is highlighted with green and 'ok'

CONTINUE

Figure 7.5 Solution space and exclusion tables

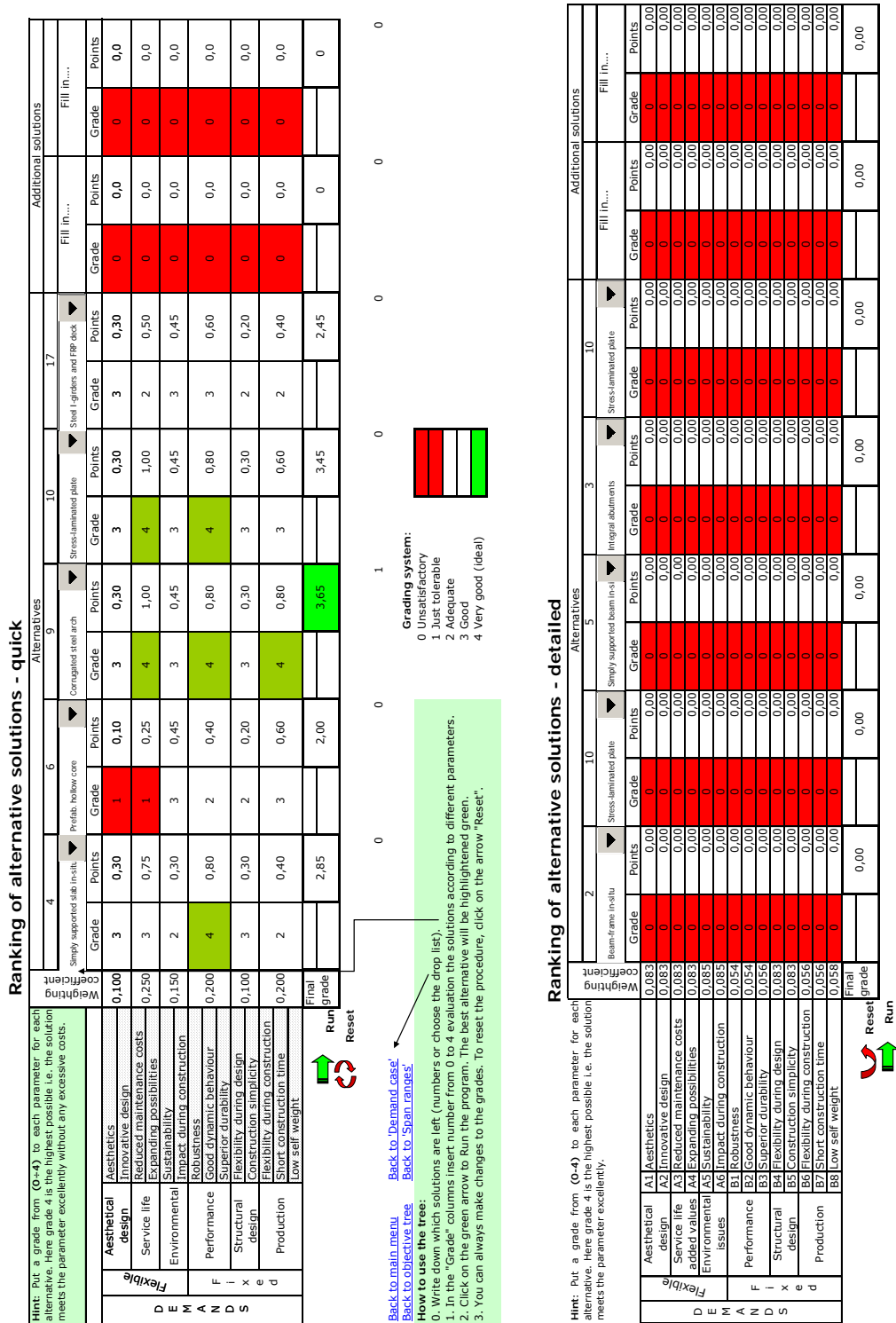

Figure 7.6 Ranking matrixes, quick (left) and detailed (right)

Appendix B: Questionnaires

Summary of questionnaires

NOTE: All the questions concern only **short-span bridges (up to 30 m in length)**

How do you approach conceptual design of bridges? Which guidelines do you use?

There are no specific guidelines or procedures, which are used for conceptual design. Mostly designers use their personal experience keeping in mind for specific project requirements of the client. If designers don't have sufficient experience, they discuss the project with their senior colleagues. First of all the conceptual design is evaluated in house and then with the owner (client).

In conceptual design the opinion of engineers from other fields also plays an important role, so for a successful conceptual design the collaboration with road designers, geotechnical engineers and landscape architects is very important.

From client's point of view the most important requirement is the economy, especially for small bridges where the client is not putting much importance to aesthetics. One problem in conceptual design is how to achieve the cheapest and simplest design. For example, concrete frame structure is considered the cheapest way to construct a short span bridge.

What are the most important questions/aspects you need to answer/consider in order to start your work?

The most important aspects that a designer needs to know are the client's requirements. After this, the budget for the bridge (including cost of construction and maintenance) must be known and then aesthetical aspects are considered as well. From aesthetical point of view, the type and location of obstacle is important. To select the type of the structural system it is important to know the ground conditions and expected length (span) of the bridge.

Do you think there is a typical demand/desire that clients want to apply in the projects?

The client always demands an economical solution with high quality and low maintenance cost. Bridge engineers come up with a rough cost estimates in MKr/m². Clients may have some special demands in some cases. For example, for fauna bridges the client is more concerned about the shape of the bridge because it should look natural and welcoming for animals.

How do you achieve/fulfill the above mentioned typical demands?

There are different ways to achieve economy. Some of those include:

- a) Minimize the surface of the bridge, i.e. shorter spanning bridge.
- b) Minimize the width of the bridge
- c) Select a cross section, which is easy to build
- d) Simple shape can save the formwork cost
- e) The length is the most efficient way to cut the price

What are the most typical geotechnical conditions you work with? And do they affect conceptual design?

In Sweden almost all types of soil are present: clay, rock, and frictional material. So, the designer is prepared to handle all kinds of situations. Geotechnical conditions affect mostly foundation system and to some extent superstructure.

What are the most typical site conditions/constraints you work with?

It's hard to define the typical site conditions/constraints. Generally speaking, availability of space and environmental restrictions are the most common constraints that designer works with.

How often does a re-design in concept happen and what are the most common reasons for that (requirements, constraints...)?

Redesign in a concept may happen. Sometimes it is because of a request from the client. Clients often work simultaneously with the consultancy and make more research on the specific project. It also happens that consultants propose a change after some further considerations. Often the geotechnical data is scarce, and at later stages of design it becomes clearer. This sometimes provokes changes in concept.

What are the current/nowadays problems in your field that you think should be improved?

It is very important to find out the current problems in the conceptual design field. On the other hand it's difficult to come up with one unified answer because it is more related to the designer's personal opinion. However, most of the interviewed specialists agreed that lack of time for the conceptual design is a common problem. In most of the cases the time given for conceptual design is very short. To overcome this problem, specialists agreed that conceptual design can be optimised and that knowledge from previous projects needs to be organised in a better way in order to save time.

Do you have a more preferred material/concept? Why?

Concrete is more preferred material to work with because it's cheaper. On the other hand it depends on a project-to-project basis. For example, if the span is less than 20 m, concrete deck is the most common solution, but if the span length is longer than 20 m then it's difficult to handle the self weight of the bridge and lighter material would be a better option.

Are there any new technologies, materials you would like to use or experiment with?

In Sweden almost 90 % of all bridges are made from concrete. Steel bridges are not common for short spans. Some engineers want to try timber bridges for traffic, some would like to work in projects where steel is a major component, and some would like to work in prefabricated bridges. Moreover, some engineer would like to use or experiment with composite structures like

- a) Wood + concrete
- b) Wood + steel
- c) Concrete + carbon-fibre composites

What stopped you in implementing them?

Designers would like to use or experiments with other materials as well but due to limited time and money available for conceptual design, they have to optimise his limitations. Moreover, the area of expertise and specialisation of the consultancy is also one of the factors, which stop designers from implementing the new trends in the market. For example, firms, which are experts in designing bridges in concrete, always want to have a solution in concrete. Since they have more knowledge and developed procedures, they don't want to take risks as new trends always need time and money.

Furthermore, as the common client is currently conservative in spending money, the possible solution to this problem is that the client should invest more in pilot and experimental projects.

Appendix C: Feedback for the toolbox

From user C1, Eric Lindbom, Ramböll Sverige AB, Gothenburg

What do you think about the methodology which was developed?

I think it can be useful as a supplement in the conceptual design phase. I think the most interesting thing is that it might point out some options that you wouldn't have thought of otherwise.

Is it user-friendly?

Yes, although some of the instructions could be even more descriptive. On the other hand if you have done it ones, you know it.

Can you point out some questions or navigations, which were confusing?

I think I pointed those out when doing the case study.

What drawbacks have you found?

The 'real' conceptual design process is kind of iterative. For example: the span affects which construction type to choose but the construction type might also affect the span. In this aspect the methodology has some limitations.

What do you think about the time to complete? Is it really time taking or rather quick one?

If you know the input data it is quite quick. If you do not know the input data it will take some time but that means that you are forced to ask yourself or your client those questions, which is a good thing.

Do you think it will be useful in your future work? Will you use it in your professional carrier?

I would like to use it as a supplement in the beginning of a new project to verify the usefulness.

From user C2, Mattias Hansson, Ramböll Sverige AB, Gothenburg

What do you think about the methodology, which was developed?

It is useful for documentation and during the work and communication with the client.

Is it user-friendly?

It is rather user friendly but I felt that I needed more background knowledge of the methodology behind the toolbox in order to be more effective.

Can you point out some questions or navigations which were confusing?

More evaluation is needed in order to know what the effects of certain grades are. The model should be tested by the user before using it with the client in order to gain confidence in the relation between input and output.

What drawbacks have you found?

It is quite hard to use all the range of grades (0-4) in the evaluation matrix. It demands more experience with the toolbox to get confident in using the full grading system, probably because of the labels of the grading.

What do you think about the time to complete? Is it really time taking or rather quick one?

It is very much worth to use it as a background material (documentation) and a head start for further detailed design. A good overview of the project means security for the client. The time to use it is well spent.

Do you think it will be useful in your future work? Will you use it in your professional carrier?

It is a new input and useful way of overviewing the different possibilities that the client is able to continue with in the project.

From user C3, Christer Carlsson, Ramböll Sverige AB, Stockholm

What do you think about the methodology, which was developed?

It was done in a proper way covering every kind of option. It provides a very good start to reduce the amount of possible solutions (for example, consider five instead of twenty options).

Is it user-friendly?

It was quite good. When the user gets used to it, no problems could be expected.

Can you point out some questions or navigations which were confusing?

The grading was not an easy task. Probably only three (1-3) grades would be enough instead of 0-4. More grades are definitely not needed.

What drawbacks have you found?

The height requirement is not included, i.e. the minimum clearance needed is not reflected in the guidelines. This height affects the choice of solution as well. It is hard to answer and distribute points among flexible parameters.

What do you think about the time to complete? Is it really time taking or rather quick one?

I think it took a decent amount of time (40 min) but this was probably because this was my first encounter with the toolbox.

Do you think it will be useful in your future work? Will you use it in your professional carrier?

I think it can be very useful as a checklist. The bridge designer could start his work the usual way by proposing a concept he thinks is the most appropriate. After this, he can use the guidelines to see if anything important is missing or re-evaluate his choice.

Hint: Put a grade from (0÷4) to each parameter for each alternative. Here grade 4 is the best possible.

D E M A N D S	Flexible	Client input	Alternatives																
			1				4				6				10				17
			Slab frame in-situ		Simply supported slab in-		Prefab. hollow core		Stress-laminated plate		Steel I-girders and FRP de								
Grade	Points	Grade	Points	Grade	Points	Grade	Points	Grade	Points	Grade	Points	Grade	Points	Grade	Points				
Aesthetical design	6,0	12,0	2	12,0	2	12,0	1	6,0	3	18,0	2	12,0	2	12,0	2	12,0			
Service life	18,0	54,0	3	36,0	2	36,0	2	36,0	2	12,0	2	12,0	2	36,0	2	36,0			
Environmental	6,0	6,0	1	6,0	1	6,0	2	12,0	3	18,0	2	12,0	2	12,0	2	12,0			
Performance	35,0	105,0	3	105,0	3	105,0	2	70,0	2	70,0	2	70,0	2	70,0	2	70,0			
Structural design	14,0	14,0	1	14,0	1	14,0	2	28,0	3	42,0	2	42,0	3	42,0	3	42,0			
Production	21,0	21,0	1	21,0	1	21,0	1	21,0	2	21,0	2	21,0	2	21,0	1	21,0			
Final grade		212		194		173		202		193									

Figure 7.8 Results for user C1

D E M A N D S	Flexible	Alternatives																
		4				6				9				10				17
		Simply supported slab in-s		Prefab. hollow core		Corrugated steel arch		Stress-laminated plate		Steel I-girders and FRP de								
Grade	Points	Grade	Points	Grade	Points	Grade	Points	Grade	Points	Grade	Points	Grade	Points	Grade	Points	Grade	Points	
Aesthetical design		3	30,0	1	10,0	3	30,0	3	30,0	3	30,0	3	30,0	3	30,0	3	30,0	
Service life		3	75,0	1	25,0	4	100,0	4	100,0	4	100,0	4	100,0	2	50,0	2	50,0	
Environmental		2	30,0	3	45,0	3	45,0	3	45,0	3	45,0	3	45,0	3	45,0	3	45,0	
Performance		4	80,0	2	40,0	4	80,0	4	80,0	4	80,0	4	80,0	4	80,0	3	60,0	
Structural design		3	30,0	2	20,0	3	30,0	3	30,0	3	30,0	3	30,0	3	30,0	2	20,0	
Production		2	40,0	3	60,0	4	80,0	4	80,0	4	80,0	4	80,0	3	60,0	2	40,0	
Final grade			285		200		365		345		245							

Figure 7.9 Results for user C2

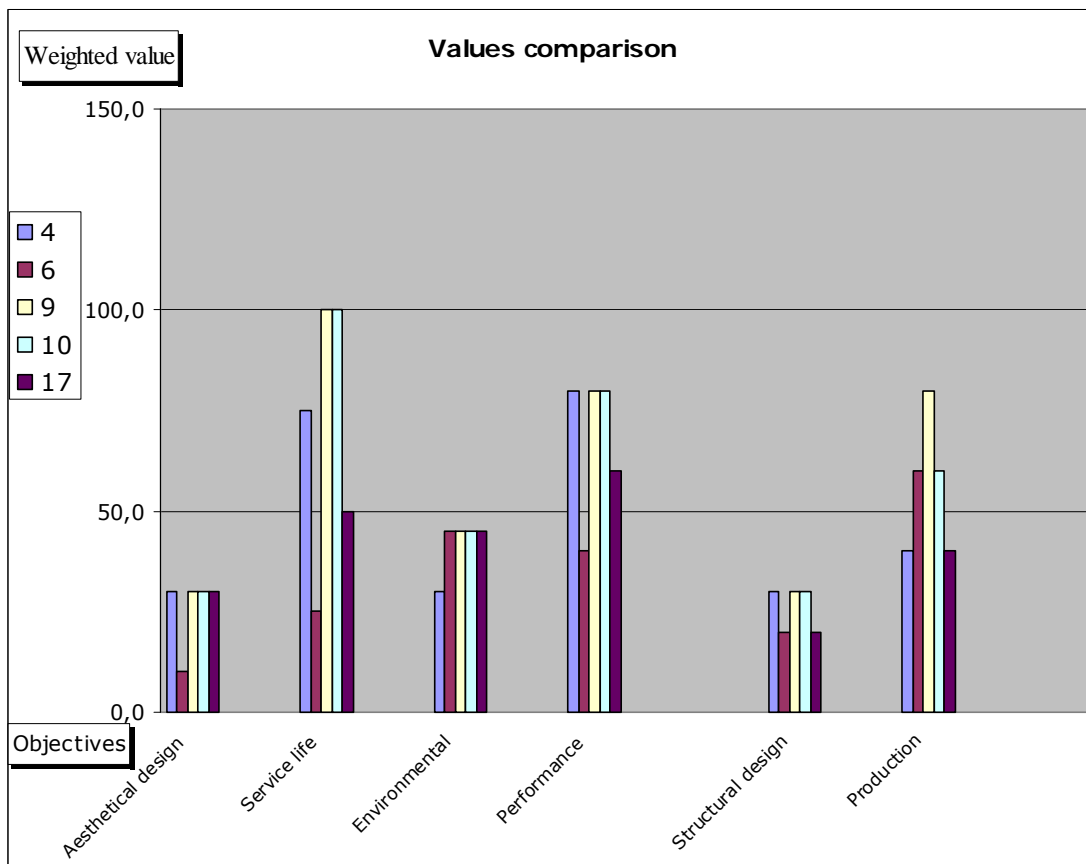
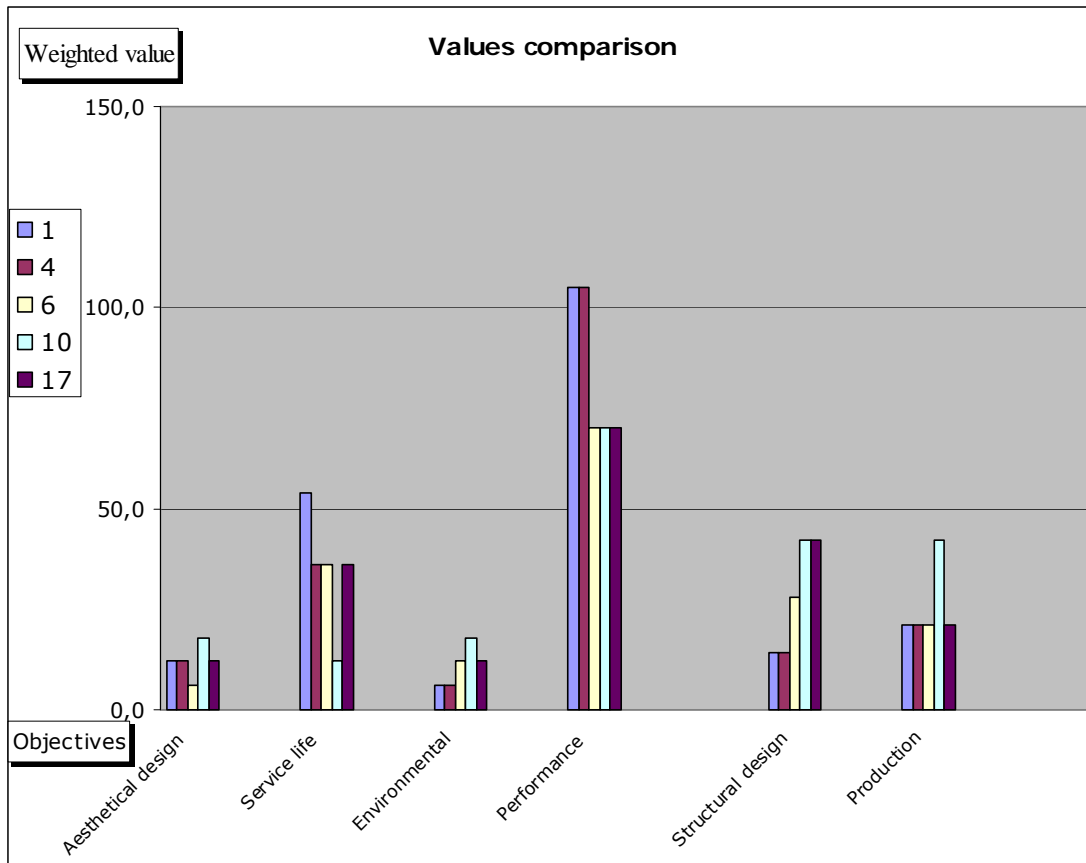

Figure 7.10 Value comparison for Backån. User C1 (above), C2 (below)

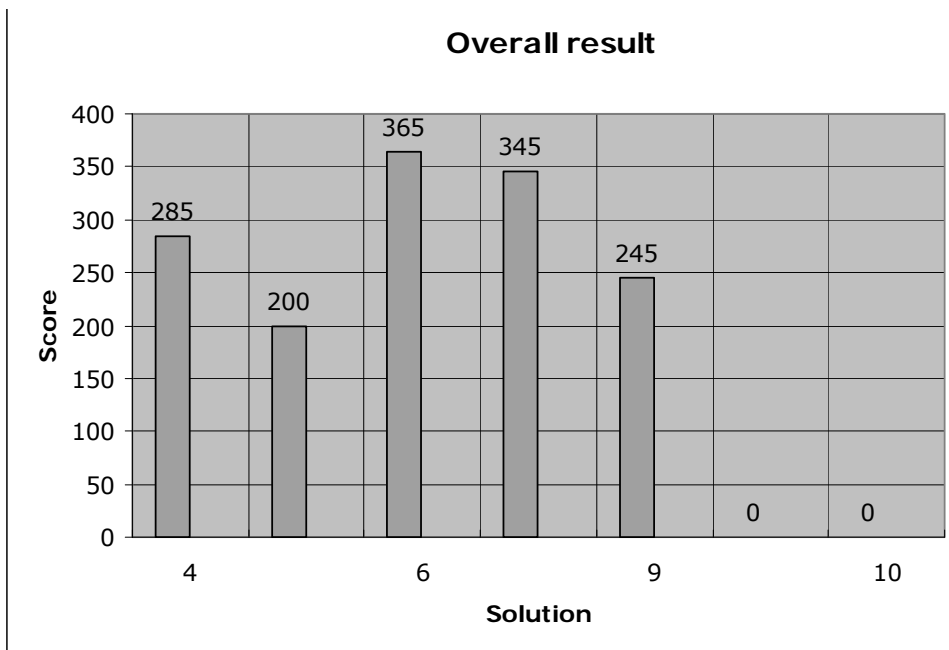
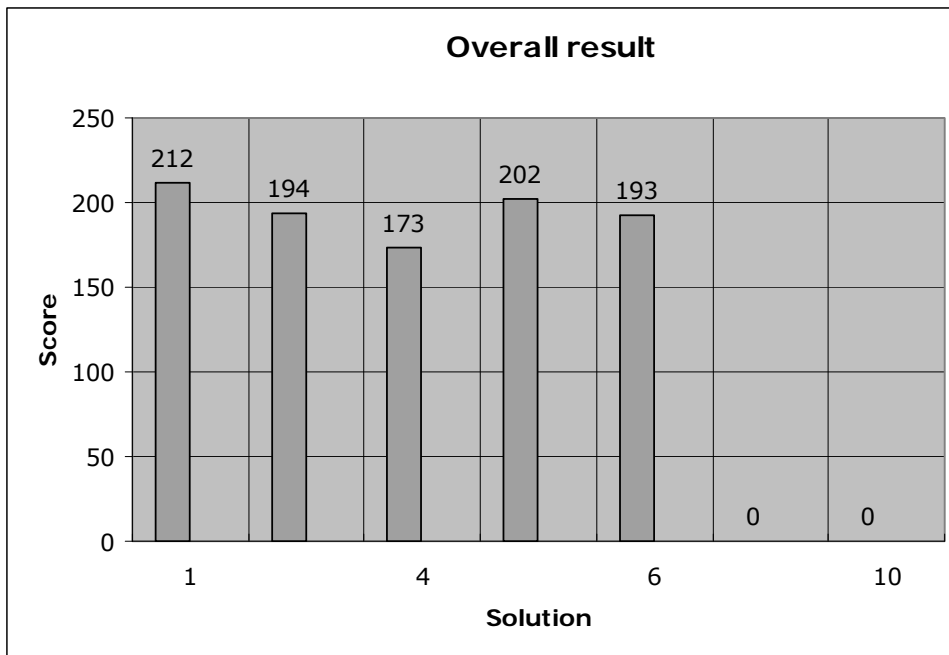

Figure 7.11 Comparative tables for the final results. User C1 (above), C2 (below)

Case study two: Brücke bridge

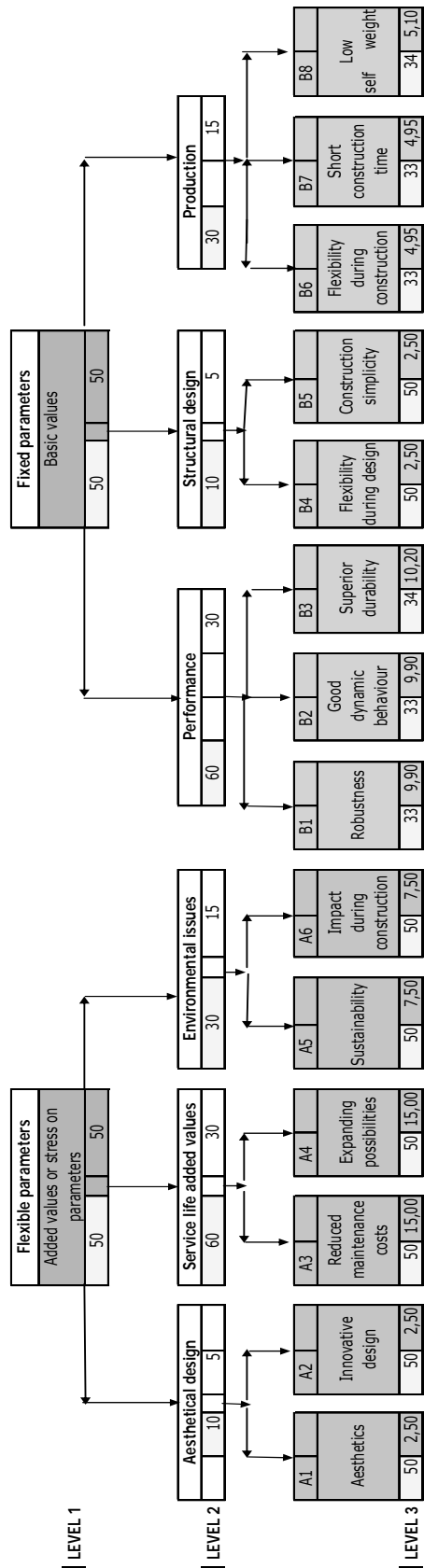

Figure 7.12 'Objective tree' for Brücke bridge.

D E M A N D S	Flexible	Weighting Coefficient	Alternatives										Additional solutions			
			1		2		3		4		5		Fill in....		Fill in....	
			Grade	Points	Grade	Points	Grade	Points	Grade	Points	Grade	Points	Grade	Points	Grade	Points
		0,050	4	0,20	4	0,20	4	0,20	3	0,15	3	0,15	0	0,00	0	0,00
		0,300	4	1,20	4	1,20	4	1,20	4	0,20	4	0,20	0	0,00	0	0,00
		0,150	3	0,45	3	0,45	3	0,45	3	0,45	3	0,45	0	0,00	0	0,00
		0,300	4	1,20	4	1,20	2	0,60	4	1,20	4	1,20	0	0,00	0	0,00
		0,050	4	0,20	3	0,15	2	0,10	3	0,15	3	0,15	0	0,00	0	0,00
		0,150	3	0,45	2	0,30	4	0,60	3	0,45	2	0,30	0	0,00	0	0,00
		Final grade		3,70		3,50		3,15		2,60		3,45		0,00		0,00

Grading system:

- 0 Unsatisfactory
- 1 Just tolerable
- 2 Adequate
- 3 Good
- 4 Very good (ideal)

Back to main menu
 Back to objective tree
How to use the tree:
 0. Write down which solutions are left (numbers or choose the drop list).
 1. In the "Grade" columns insert number from (0÷4) grading alternatives according to different parameters.
 2. Input grade in horizontal order i.e. give all grades for "Aesthetical design" to all solutions.
 3. Click on the green arrow to Run the program. The best alternative will be highlighted green.
 4. You can always make changes to the grades. To reset the procedure, click on the arrow "Reset".
 5. Write comments for each grade to explain your input.

Figure 7.13 Ranking (evaluation) matrix for Brücke bridge.

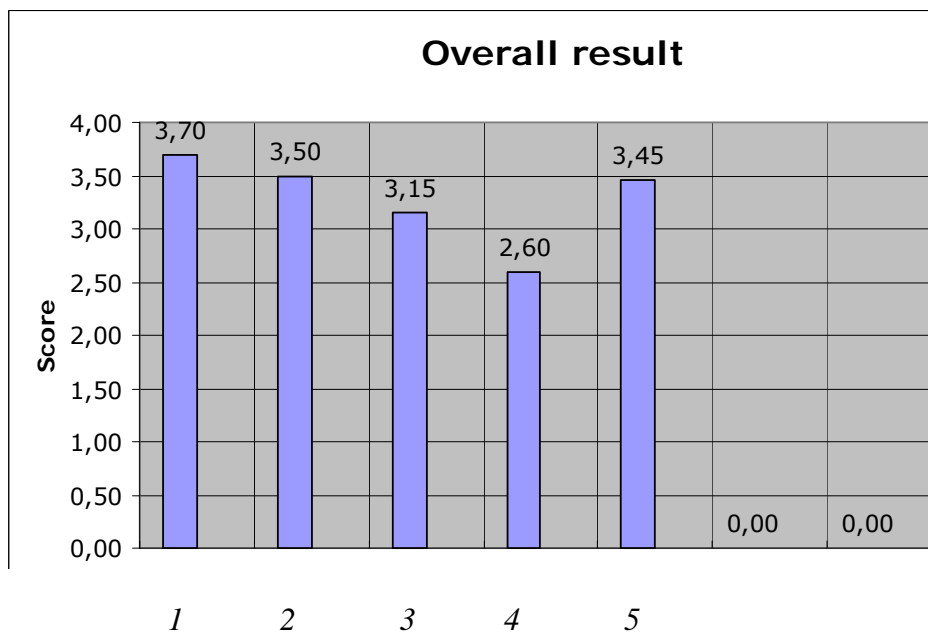
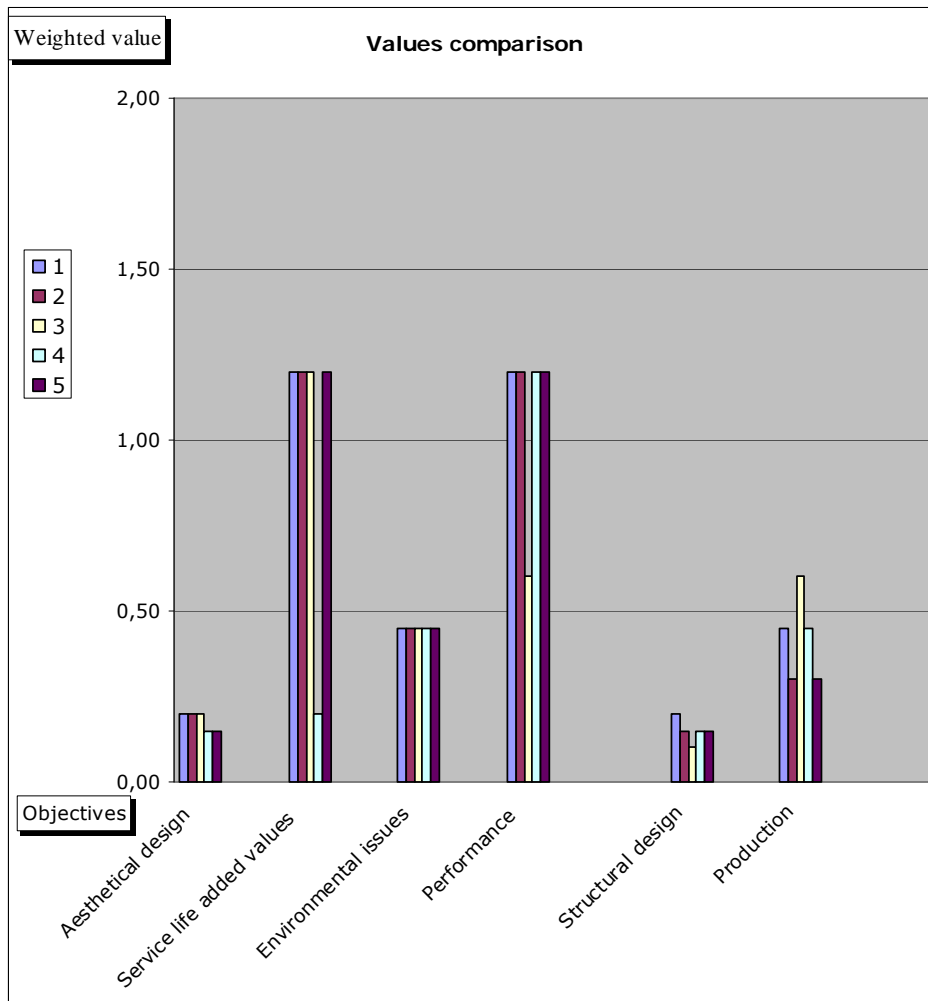

Figure 7.14 Comparative tables for Brücke bridge.