

# CHALMERS

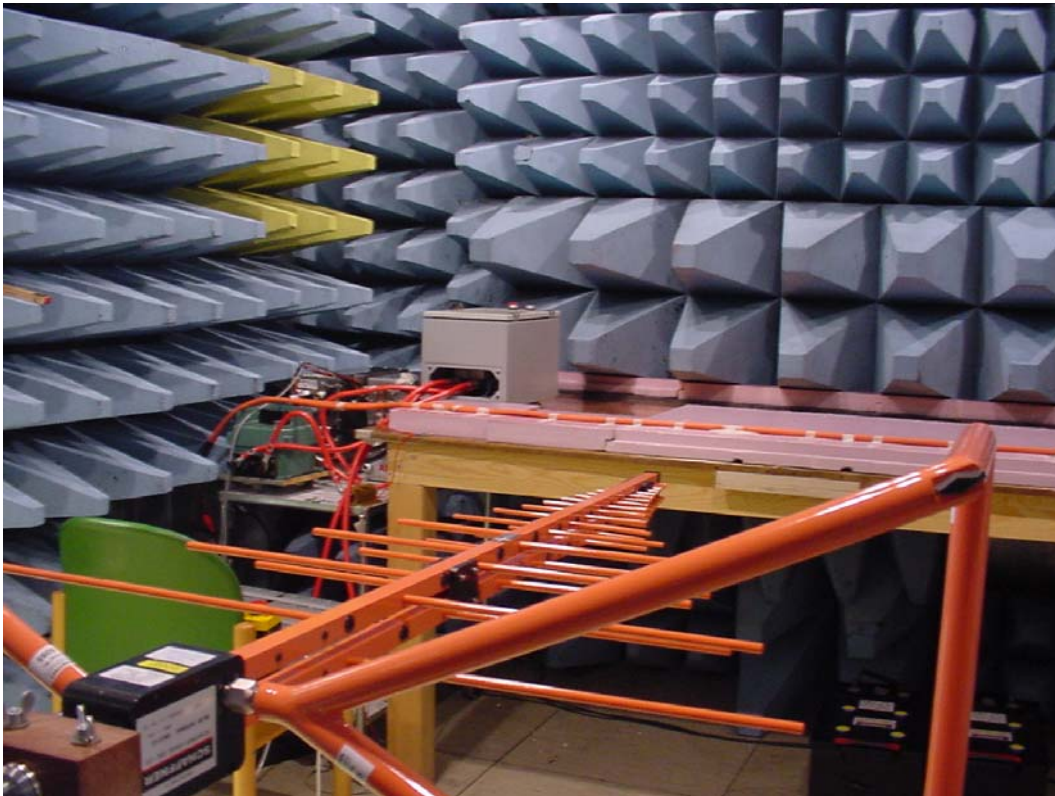

## Cable Concept Selection for 600V Hybrid Heavy Duty Vehicle from an EMC Perspective

*Master of Science Thesis*

MICHAELA SUNDIN

Department of Energy and Environment  
Division of Electric Power Engineering  
CHALMERS UNIVERSITY OF TECHNOLOGY  
Göteborg, Sweden, 2007



# Cable Concept Selection for 600 V Hybrid Heavy Duty Vehicle from an EMC Perspective

MICHAELA SUNDIN

Cable Concept Selection for 600 V Hybrid Heavy Duty Vehicle from an EMC  
Perspective  
MICHAELA SUNDIN

© MICHAELA SUNDIN, 2007.

Department of Energy and Environment  
Chalmers University of Technology  
SE-412 96 Göteborg  
Sweden  
Telephone + 46 (0)31-772 1000

Cover:  
Setup of the electric field measurements in the EMC test cell,  
More information about the electric field measurements can be  
found in Chapter 7.4 - Electric Field Measurements which starts on page 48.

Elanders  
Göteborg, Sweden 2007

---

## Abstract

It is important to minimize the emissions of electromagnetic fields to assure that the electrical equipment work properly. This thesis examines how to minimize electromagnetic fields with different cable types and placing of the cables. The cables are intended to be used in a hybrid heavy duty vehicle, for 600 V DC. Three different cable types was examined, one unshielded type, one shielded type and one type with two conductors with a common shield. The emissions of electric field from the cables were measured separately from the magnetic field emissions.

The results of the measurements show that the electric field emissions are minimized by a shielded cable. The unshielded cables have a difference of 8 dB $\mu$ V to the shielded cables at 0.15 MHz, and at 0.60 MHz is the difference increased to 18 dB $\mu$ V. The magnetic field emissions are not affected by the cable type it is only affected by the placing of the cables. At 10 A is the magnetic field 28  $\mu$ T when the cables are placed with 5 cm between them. When the cables have no distance between them the magnetic field is cancelled. Both the electric field and the magnetic field are minimized by a placing of the cables with no distance between them. If the cables are placed next to a grounded girder the electric field emissions is lowered with about 5 dB $\mu$ V. If the girder is made of a material which conducts magnetic flux the magnetic field emissions is increased. The girder prevents the electromagnetic field to spread in four directions; it limits the emissions to three dimensions.

---

---

## Acknowledgement

I would like to thank Niklas Bengtsson, who was my supervisor at Volvo Powertrain AB, for the great support during my thesis work.

Thank you Torbjörn Thiringer, my supervisor at Chalmers University of Technology, for answering all my questions and helping out at short notice.

I am very grateful for the help from Kenneth Alklind and Ulf Herbertsson at Volvo 3P who helped me implement the measurements of electric fields and magnetic fields. Thank you for answering all my questions. I would also like to thank Jonas Wählström at Volvo 3P who gave us ideas of new approaches when we got stuck.

Thank you Jens Groot, Volvo Technology AB, for helping me to get hold of the hardware and the support of the hardware.

Thank you all for helping me to implement my thesis work. I am very grateful to all of you who have helped me.

*Michaela Sundin*

---



---

## **Preface**

This report is the result of a Master Thesis in electric power engineering. The thesis will be comprised in 20 weeks by one student who is finishing a Master Thesis in Electric Power Engineering at Chalmers University of Technology; the thesis will be accomplished at Volvo Powertrain AB, in Gothenburg. Thomas Hagenlöv from Volvo Powertrain AB will help to select the cables types to examine. The measurements of the electric and magnetic fields will be performed at Volvo 3P in a shielded test cell.

---

---

# Table of Contents

<b>1</b>	<b>INTRODUCTION .....</b>	<b>1</b>
1.1	BACKGROUND .....	1
1.2	RELATED WORK .....	1
1.3	SCOPE OF THESIS .....	1
1.4	PROCEDURE OF THESIS .....	1
1.5	LAYOUT OF THESIS REPORT .....	2
<b>2</b>	<b>ELECTROMAGNETIC FIELDS .....</b>	<b>3</b>
2.1	ELECTROMAGNETIC FIELD THEORY .....	3
2.2	ELECTROMAGNETIC INTERFERENCE AND ELECTROMAGNETIC COMPATIBILITY .....	4
2.3	SUSCEPTIBILITY .....	4
2.3.1	<i>Electric Susceptibility</i> .....	4
2.3.2	<i>Magnetic Susceptibility</i> .....	4
2.3.3	<i>Electromagnetic Susceptibility</i> .....	5
2.4	REQUIREMENTS FOR EMISSIONS AND SUSCEPTIBILITY .....	5
2.5	METHODS FOR MEASURING OF ELECTROMAGNETIC FIELDS .....	5
2.5.1	<i>Loop Antenna</i> .....	5
<b>3</b>	<b>CABLES .....</b>	<b>7</b>
3.1	CABLE THEORY .....	7
3.2	THE TEST CABLES .....	7
3.2.1	<i>Unshielded 50 mm<sup>2</sup> Cable</i> .....	8
3.2.2	<i>Shielded 50 mm<sup>2</sup> Cable</i> .....	8
3.2.3	<i>Two Conductor Cable</i> .....	9
<b>4</b>	<b>CABLE SETUPS AND SCENARIO TO ANALYZE .....</b>	<b>11</b>
4.1	CABLE SETUPS .....	11
4.2	PLACING OF CABLES .....	11
4.3	TEST SCENARIO .....	11
<b>5</b>	<b>POWER ELECTRONICS .....</b>	<b>13</b>
5.1	DC/DC-CONVERTER .....	13
5.1.1	<i>Buck Converter</i> .....	13
5.1.2	<i>Boost Converter</i> .....	13
5.1.3	<i>Bidirectional DC/DC-Converter</i> .....	14
5.1.4	<i>Control of DC/DC-Converter</i> .....	14
<b>6</b>	<b>CALCULATIONS .....</b>	<b>17</b>
6.1	SIMPLIFICATIONS .....	17
6.2	SETUP AND ANALYSIS .....	17
6.2.1	<i>Setup of Calculations</i> .....	17
6.2.2	<i>Setup of Electric Field Calculations</i> .....	17
6.2.3	<i>Setup of Magnetic Field Calculations</i> .....	18
6.2.4	<i>Analysis Procedure</i> .....	19
6.3	CALCULATIONS OF THE ELECTRIC FIELD .....	20
6.3.1	<i>Results of Unshielded Cables</i> .....	20
6.4	CALCULATIONS OF THE MAGNETIC FIELD .....	27
6.4.1	<i>Results of Unshielded Cables</i> .....	27
6.4.2	<i>Results of Shielded Cables</i> .....	34
6.4.3	<i>Results of Two Conductor Cables</i> .....	41
6.5	CONCLUSIONS OF THE CALCULATIONS .....	44
<b>7</b>	<b>MEASUREMENTS .....</b>	<b>47</b>
7.1	SIMPLIFICATIONS .....	47
7.2	THE TEST CIRCUIT .....	47
7.3	MEASUREMENT INSTRUMENTS .....	47
7.4	ELECTRIC FIELD MEASUREMENTS .....	48
7.4.1	<i>Result</i> .....	48
7.4.2	<i>New Test Setup</i> .....	49

---

7.4.3	<i>Results of Electric Field Measurements</i> .....	50
7.5	MAGNETIC FIELD MEASUREMENTS.....	55
7.5.1	<i>Test Setup</i> .....	55
7.5.2	<i>Measurement Method</i> .....	55
7.5.3	<i>Results</i> .....	56
7.6	DISCUSSION OF THE MEASUREMENTS .....	56
7.7	COMPARISON WITH CALCULATIONS.....	57
<b>8</b>	<b>CONCLUSION</b> .....	<b>59</b>
<b>9</b>	<b>FUTURE WORK</b> .....	<b>61</b>
<b>10</b>	<b>REFERENCES</b> .....	<b>63</b>
	<b>APPENDIX A – RESULTS OF ELECTRIC FIELD MEASUREMENTS</b> .....	<b>65</b>
	<b>APPENDIX B – PHOTOS FROM THE MEASUREMENTS</b> .....	<b>67</b>

---

## List of Abbreviations

AC	Alternating Current
DC	Direct Current
EMC	Electro Magnetic Compatibility
EMI	Electro Magnetic Interference
ESS	Energy Storage System
HHDV	Hybrid Heavy Duty Vehicle
HEVJB	Hybrid Electric Vehicle Junction Box
NiMH	Nickel Metal Hydride
PEC	Power Electronics Converter
PWM	Pulse Width Modulation
REMS	RADOX Elastomer S
TEM wave	Transverse Electro Magnetic wave

## List of Designations

<i>Quantity</i>	<i>Symbol</i>	<i>Unit</i>	<i>Abbreviation</i>
Area	<b>A</b>	Meter <sup>2</sup>	m <sup>2</sup>
Capacitance	<b>C</b>	Farad	F
Conductance	<b>G</b>	Siemens	S
Conductivity	$\sigma$	Siemens/meter	S/m
Electric field intensity	<b>E</b>	Volt/meter	V/m
Electric flux density	<b>D</b>	Coulomb/meter <sup>2</sup>	C/m <sup>2</sup>
Force	<b>F</b>	Newton	N
Inductance	<b>L</b>	Henry	H
Magnetic field intensity	<b>H</b>	Ampere/meter	A/m
Magnetic flux density	<b>B</b>	Tesla	T
Permeability	$\mu_0$	Henry/meter	H/m
Permittivity	$\epsilon_0$	Farad/meter	F/m
Polarization vector	<b>P</b>	Coulomb/meter <sup>2</sup>	C/m <sup>2</sup>
Relative permeability	$\mu_r$	-	-
Relative permittivity	$\epsilon_r$	-	-
Resistance	<b>R</b>	Ohm	$\Omega$
Susceptibility	$\chi$	-	-
Unit charge	<b>q</b>	Coulomb	C
Velocity	<b>u</b>	Meter/second	m/s

---

# 1 Introduction

This chapter is an introduction to the thesis report. The purpose and the procedure of the thesis are described. There is a description of the layout of the report at the end of this chapter.

## 1.1 Background

Hybrid technology is very popular these days due to the discussion about the oil reserves running dry and the greenhouse effect. Many companies are trying to make their own hybrid vehicle in order to improve the environment and satisfy their costumers increased environmental awareness. Hybrid technology for heavy duty vehicles is a new area and needs a higher voltage level than a car. The high voltage and current level causes higher field strengths. The fields need to be suppressed to ensure that components which are important for safety related functions in the vehicle are functioning properly. Suppression is not only made to ensure safety it is also important that the comfort equipment work satisfactory.

## 1.2 Related Work

The hybrid technology is a new technology and is very rare, the thesis has been running parallel with the development of a hybrid heavy duty vehicle at Volvo Powertrain AB. There has been pre-study reports and design guidelines done in cable routing for high voltage distribution in vehicles at Volvo Technology AB before.

## 1.3 Scope of Thesis

The scope of this Master thesis is to examine electromagnetic radiated emissions in DC cables for a 600 V application in a hybrid heavy duty vehicle, HHDV. Also the suitability of various placements of the cables, for instance if they should be placed next to ground or if they should lie free from ground is examined. The cables will only be examined from an electrical point of view, not from vibration, heat, abrasion etc. point of view. The goal is to recommend a cable which will minimize the electromagnetic emissions.

## 1.4 Procedure of Thesis

A couple of different cables will be selected, for which the electromagnetic fields will be calculated and tested in an EMC laboratory. The datasheets of the cables will be studied to find out the composition and characteristics of the cable. The electromagnetic field of the cables will be calculated with Comsol Multiphysics, version 3.3. The main task of the thesis is the EMC test in the laboratory; therefore the calculations will be slightly simplified. The EMC test will measure the electromagnetic emissions of the cables and how the electromagnetic field depends on the distance between the cables and distance to ground etc. The calculations will be compared with the measurements to evaluate the results of the measurements in order to find which cable and placement is suitable to recommend for use in the HHDV. The cables which are in the field of study are the 600 V DC cables from the AC/DC converter to the High Voltage Junction Box, HEVJB, see Figure 1.1.

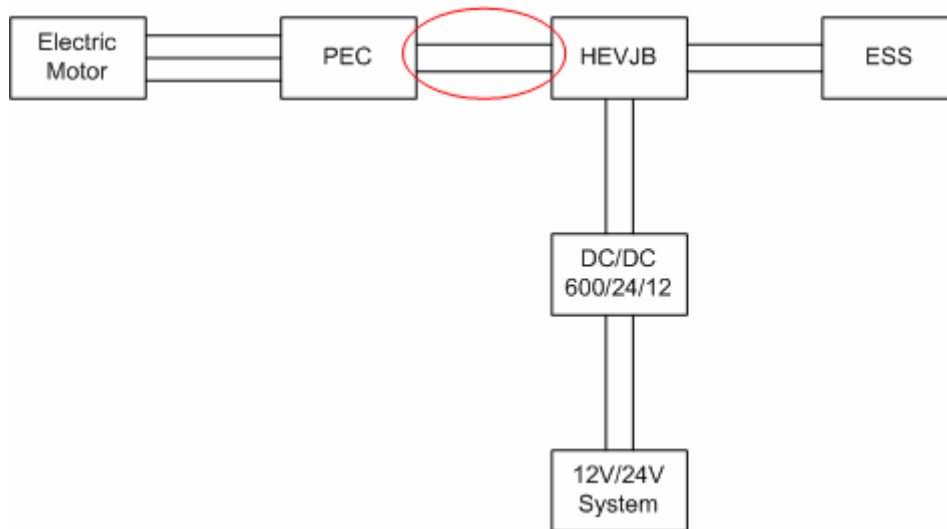

Figure 1.1 - The location of the cables in the present study.

## 1.5 Layout of Thesis Report

The first chapter gives a description of the purpose and the scope of the thesis. Next there will be a brief review of electromagnetic field theory to introduce commonly used terms, electromagnetic compatibility and electromagnetic interference. Following, there is a chapter describing the cables where cable theory will be handled and the cables which will be tested during the laboratory experiment will be presented. The cable setup, the placement of the cables and the test scenario will be described in Chapter 0. Chapter 5 is a chapter about power electronics, and describes how the DC/DC-Converter works. Chapter 6 handles the calculations; both the setup and the results will be presented. In Chapter 7 the description of the laboratory setup and the results of the laboratory experiment can be found. In Chapter 8 the conclusion of this Master thesis is presented. Chapter 9 will give suggestions of future work to be done. The chapters following Chapter 9 are references and appendix, the first appendix contains the result from the electric field measurements, the second contains photos from the measurements.



## 2 Electromagnetic Fields

This chapter starts with an introduction to electromagnetic field theory. Then a discussion of electromagnetic compatibility, EMC, electromagnetic interference, EMI, and susceptibility will follow. The Volvo standard for EMC and susceptibility will be presented, and in the end there is a presentation of measuring methods of electromagnetic fields.

### 2.1 Electromagnetic Field Theory

There are four fundamental fields in the area of electromagnetics; electric field intensity, electric flux density, magnetic flux density and magnetic field intensity [1].

For electrostatic fields in free space it is only necessary to consider electric field intensity. The electric field intensity is the force an electric charge experiences in an electric field, denoted  $\mathbf{E}$  and has the unit V/m [1].

$$\mathbf{E} = \frac{\mathbf{F}_e}{q} \quad (2.1)$$

where  $q$  is an electric charge, C.  $\mathbf{F}_e$  is the electric force that the charge experiences, with the unit N.  $\mathbf{E}$  is the electric field, with the unit V/m. If a polarized dielectric is inserted in the electric field the electric field intensity will be affected. When the dielectric medium is present in the electric field consideration must be taken to a component  $\mathbf{P}$ , which is dependent on the bound polarization charges in the dielectric and the electric displacement component  $\mathbf{D}$ , which is dependent on free charges [2].  $\mathbf{D}$  is called electric flux density or electric displacement and the unit is C/m<sup>2</sup>.

$$\mathbf{D} = \varepsilon_0 \mathbf{E} + \mathbf{P} \quad (2.2)$$

where  $\varepsilon_0$  is the permittivity in free space, F/m.  $\mathbf{E}$  is the electric field, V/m.  $\mathbf{P}$  is the polarization vector, C/m<sup>2</sup>.  $\mathbf{D}$  is the electric flux density, C/m<sup>2</sup>.

Magnetic flux density is the only vector needed when magnetostatic fields in free space are considered. The magnetic flux density is related to magnetic force and velocity of a charged particle moving in a magnetic field, magnetic flux density is noted with  $\mathbf{B}$  and the unit is T.

$$\mathbf{F}_m = q\mathbf{u} \times \mathbf{B} \quad (2.3)$$

where  $q$  is a charge, C.  $\mathbf{u}$  is the velocity of the moving charge, m/s.  $\mathbf{B}$  is the magnetic flux density, T.  $\mathbf{F}_m$  is the magnetic force which the electric charge experiences. When there is a magnetic material present, the external magnetic field will align both the internal dipoles moment and the induced dipoles moment which will result in a different resultant of the magnetic flux density than the magnetic flux in free space. The magnetic field is defined as magnetic field intensity when there is a magnetic material present, it is noted as  $\mathbf{H}$  and the unit is A/m.

$$\mathbf{H} = \frac{\mathbf{B}}{\mu} \quad (2.4)$$

where  $\mathbf{B}$  is the magnetic flux density, T.  $\mu$  is the absolute permeability, which has the unit H/m, and  $\mathbf{H}$  is the magnetic field intensity, A/m.

When the fields are not varying in time, the electric field and magnetic field form two separate vectors. A magnetic field which is varying in time gives rise to an electric field and an electric field which is varying in time gives rise to a magnetic field, resulting in

an electromagnetic field [3]. The following equation is called Lorentz's force equation and it is a fundamental postulate and can not be derived from other postulates.

$$\mathbf{F} = q(\mathbf{E} + \mathbf{u} \times \mathbf{B}) \quad (2.5)$$

where  $q$  is a electric charge, C.  $\mathbf{E}$  is the electric field, V/m.  $\mathbf{u}$  is the velocity of the moving charge, m/s.  $\mathbf{B}$  is the magnetic flux density, T.  $\mathbf{F}$  is the total electromagnetic force, N.

## 2.2 Electromagnetic Interference and Electromagnetic Compatibility

Electromagnetic interference, EMI, is disturbances by an unwanted voltage or current which affect electrical equipment and prevent the equipment from working properly [4]. When electrical equipment is working properly within itself and in the electromagnetic environment where it is placed, is called electromagnetic compatibility, EMC [5]. EMI emissions can be radiated through conductors and disturb several surrounding components. Suppression of EMI can be done in several ways, but normally suppression of the source of EMI is to prefer since the source can disturb many components, but suppression can also be applied to either the path or the surrounding components. There are numerous suppressing techniques, amongst others are shielding, grounding and filtering [6]. Devices can be shielded e.g. by metal boxes. The cables between electrical equipment works like antennas and picks up and radiate noise. The antenna phenomenon is a great threat to the device, to reduce the influence, the cable can be shielded. To achieve the best protection against EMI, the shielding of the cable should be designed to be an extension of the metal box of the device. Performance of the shield is determined by the characteristics of the shield, geometry, material and thickness. The reason for reducing EMI emissions is not only to reduce the disturbances EMI cause to the electrical equipment in the surrounding; electromagnetic fields may also have biological effects and cause various kinds of sickness.

## 2.3 Susceptibility

### 2.3.1 Electric Susceptibility

Electric susceptibility is a measure of the ease to polarize a dielectric material. Electric susceptibility is noted by  $\chi_e$  and is a positive and dimensionless quantity.

$$\mathbf{P} = \varepsilon_0 (\varepsilon_r - 1)\mathbf{E} = \varepsilon_0 \chi_e \mathbf{E} \quad (2.6)$$

where  $\varepsilon_0$  is the permittivity in free space, F/m.  $\varepsilon_r$  is the relative permittivity, which is dimensionless.  $\mathbf{E}$  is the electric field, V/m.  $\mathbf{P}$  is the polarization vector, C/m<sup>2</sup> [11].

### 2.3.2 Magnetic Susceptibility

The measure of the extent a dielectric can be magnetized is called the magnetic susceptibility. The magnetic susceptibility is noted by  $\chi_m$  and is a dimensionless quantity [12].

$$\mathbf{B} = \mu_0 \mu_r \mathbf{H} = \mu_0 (1 + \chi_m) \mathbf{H} \quad (2.7)$$

where  $\mu_0$  is the permeability in free space, H/m.  $\mu_r$  is the relative permeability, which is dimensionless,  $\mathbf{H}$  is the magnetic field intensity, A/m.  $\mathbf{B}$  is the magnetic flux density, T.

### **2.3.3 Electromagnetic Susceptibility**

The definition of electromagnetic susceptibility is the tolerance an electric circuit or component has to the influence of electromagnetic radiation [13].

## **2.4 Requirements for Emissions and Susceptibility**

The levels of emission and susceptibility must be limited; otherwise the current component might have a problem to work in a field intensive environment and will accordingly not be permitted to market. Volvo group has set a standard called STD 515-0003; current version is version 2, where the limits of the emissions and susceptibility are stated. The standard follows the legislation of the European Commission, The Commission Directive 2004/104/EC, [9] [10].

## **2.5 Methods for Measuring of Electromagnetic Fields**

The test equipment used to measure electric field strength mostly consists of dipole antennas with high input impedance. There are a couple of magnetic field measurement systems, such as the loop antenna, the Hall Effect sensor and the magnet diode amongst others; they are used to measure the magnetic field strength. When the receiver of the electromagnetic field is located near the source of the radiation it is called a near field, near fields are also called simple fields. Simple electromagnetic fields can be measured separately with the mentioned techniques or simultaneous with the single loop antenna. Far fields are when the receiver is placed far from the source. Far fields are complicated fields and must be measured simultaneously. The loop antenna was designed to measure the electric and magnetic field simultaneously [7] [8].

### **2.5.1 Loop Antenna**

The loop antenna is loaded with equal impedances at points which are diametrically opposites of each other. Across one of the loads the magnetic loop response adds to the electric dipole response and across the other load the magnetic loop response subtracts from the electric dipole response. The magnetic loop response and electric loop response can be separated by taking the sum and the difference between the currents across the loads in the diametrically opposite points of the loop. The sum of the currents gives the magnetic loop response and the difference of the currents gives the electric loop current [8].

---

### 3 Cables

This chapter will start with a brief introduction to transmission cable theory and then there will be a description of the chosen cables and their characteristics.

#### 3.1 Cable Theory

A plane wave where the electric field and the magnetic field are perpendicular to each other and both of the fields are transverse to the propagation direction is called a transverse electromagnetic wave, TEM wave. There are three common types of transmission lines that support TEM waves, parallel-plate transmission line, two-wire transmission line and coaxial transmission line. From an equivalent circuit of a two-conductor transmission line the general transmission line equations can be derived by applying Kirchhoff's voltage and current law, the circuit can be seen in Figure 3.1.

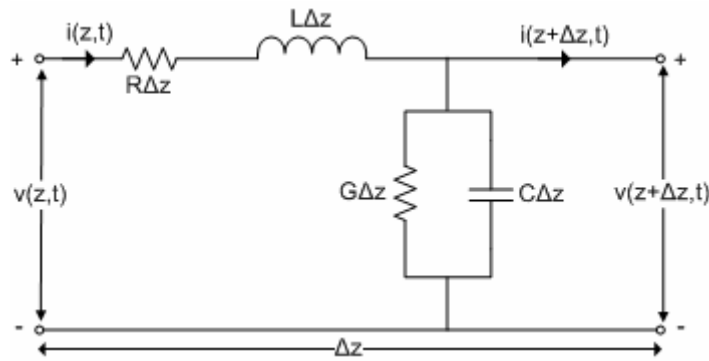

Figure 3.1 - Equivalent circuit of a two-conductor transmission line.

$$-\frac{\partial v(z,t)}{\partial z} = Ri(z,t) + L \frac{\partial i(z,t)}{\partial t} \quad (3.1)$$

$$-\frac{\partial i(z,t)}{\partial z} = Gv(z,t) + C \frac{\partial v(z,t)}{\partial t} \quad (3.2)$$

The general transmission line equations, (3.1) and (3.2), describe the transient behavior of the transmission line in most cases. The parameters are derived by using the following equations, which only applies to coaxial transmission lines.

$$R = \frac{1}{\sigma A} \quad \Omega/m \quad (3.3)$$

$$C = \frac{2\pi\epsilon}{\ln(b/a)} \quad F/m \quad (3.4)$$

$$L = \frac{\mu}{2\pi} \ln\left(\frac{b}{a}\right) \quad H/m \quad (3.5)$$

$$G = \frac{2\pi\sigma}{\ln(b/a)} \quad S/m \quad (3.6)$$

Note that all of the parameters are noted in per meter.  $A$  is the cross-section area of the conductor,  $\sigma$  is the conductivity of the conductor,  $\epsilon$  is the absolute permittivity,  $\mu$  is the absolute permeability,  $a$  is the radius of the inner conductor and  $b$  is the inner radius of the outer conductor [1].

#### 3.2 The Test Cables

Three cable types have been chosen to be examined. The first cable has one conductor and is without shield, the second cable type is a cable with one shielded conductor and

the third cable type is a cable with two conductors and a common shield. The coaxial cable and the cable without shield were chosen to examine how the electromagnetic fields are affected by the shield. The cable with two conductors with a common shield is chosen to examine how the fields are affected by the common shield. In the following subchapters there will be a discussion of the cables and in Table 3.2 a summary of the measurements of the cables is found.

All the test cables are made by Huber + Suhner AB. According to the datasheets all the cables have a wide temperature range, weather resistance and good resistance against humidity, pressure, oils abrasion and diesel fuel. The datasheets of the cables can be found on the Huber + Suhner AB webpage [14].

The conductors and shield is made of copper, the conductivity for annealed copper at 20 °C is  $5.8 \cdot 10^7$  S/m. One advantage of a braided shield is the higher flexibility of the cable. A braided shield is not as effective as a solid shield, it only provides about 60-90 % coverage [16]. RADOX Elastomer, REMS, is used both as insulation and jacket; the permittivity of REMS is 4.79 at 1 kHz and 4.11 at 1 MHz. The material constants are summarized in Table 3.1. The information about the permittivity of REMS was achieved by e-mail contact with Henrik Hogland<sup>1</sup>.

**Table 3.1 - Material constants.**

<i>Material</i>	<i>Symbol</i>	<i>Constant</i>	<i>Condition</i>
Copper	$\sigma$	$5.8 \cdot 10^7$ S/m	20 °C
REMS	$\epsilon_r$	4.79	1 kHz
REMS	$\epsilon_r$	4.11	1 MHz

### 3.2.1 Unshielded 50 mm<sup>2</sup> Cable

The first cable type is a cable with a multi stranded conductor without shielding. The conductor is made of stranded bare copper and is a class 5 conductor. Class 5 implies that the core is made of fine copper wires. The conductor consists of 7 bunches consisting of several strands and has a nominal cross-sectional area of 50 mm<sup>2</sup>; the maximal diameter of the conductor is 9.4 mm. The cable has an insulation made of REMS, the material constants of REMS can be found in Table 3.1. The minimal thickness of the insulation is 0.8 mm, and the nominal diameter of the cable is 11.5 mm. The cable can be seen in Figure 3.2.



**Figure 3.2 – Unshielded cable. © Huber + Suhner AB**

### 3.2.2 Shielded 50 mm<sup>2</sup> Cable

The second cable type is a coaxial cable with a shielded multi stranded conductor. The conductor is made of 7 copper conductors which consists of bunches of several strands. The nominal cross-section area of the conductor is 50 mm<sup>2</sup>, and the maximal diameter of the conductor is 9.4 mm. The insulation of the cable is made of REMS. The insulation has a nominal diameter of 11.5 mm. Braided tin plated copper is used as

<sup>1</sup> Henrik Hogland, Sales Engineer, Huber + Suhner AB, e-mail on 2007-02-13

shield; the maximal diameter of the shield is 12.6 mm. The jacket is also made of REMS. The nominal overall diameter of the cable is 14.9 mm. Figure 3.3 shows the cable.

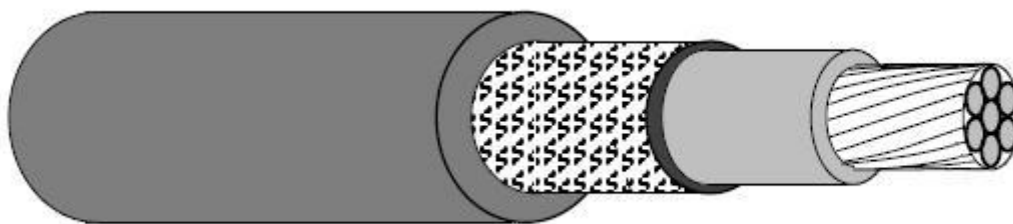

Figure 3.3 – Shielded cable. © Huber + Suhner AB

### 3.2.3 Two Conductor Cable

The third cable is a two conductor cable. The cable is not in production, but Huber + Suhner has made a prototype for the test. The conductors and the insulation are made of two unshielded 50 mm<sup>2</sup> cables which are described in section 3.2.1. The shield is made of braided tin plated copper, the maximal thickness of the shield is 1.1 mm. Outside the braid is a jacket made of shrink hose; the shrink hose has a thickness of about 1 mm. The unshielded cables are twisted inside the shrink hose. There are no filling next to the conductors, therefore the cable does not have a round profile. Figure 3.4 shows the two conductor cable if it would have a round profile.

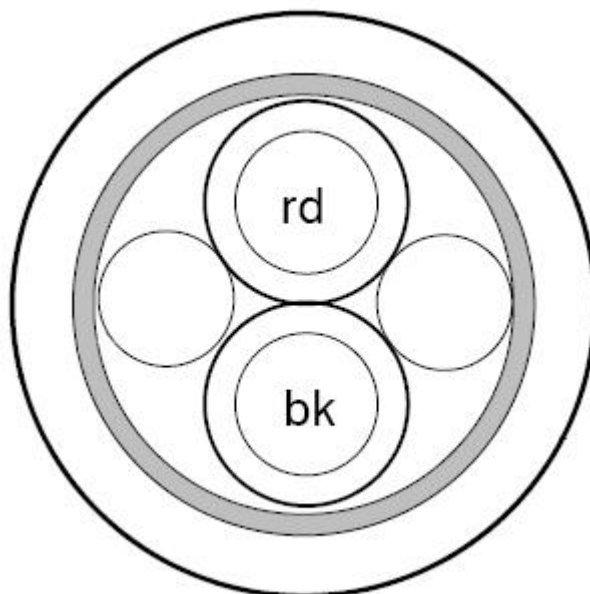

Figure 3.4 – Two conductor cable. © Huber + Suhner AB

Table 3.2 - Measures of the cables.

<i>Cable type</i>	<i>Cross-section area nom. [mm<sup>2</sup>]</i>	<i>Diameter of conductor max. [mm]</i>	<i>Diameter of insulation [mm]</i>	<i>Diameter of shield max. [mm]</i>	<i>Overall diameter nom. [mm]</i>
Unshielded	50	9.4	-	-	11.5±0.20
Shielded	50	9.4	11.5	12.6	14.9±0.3
Two Conductor	50	9.4	11.5±0.20	-	-

---



## 4 Cable Setups and Scenario to Analyze

In this chapter the different cable setups, the placing of the cables and the scenario which will be analyzed in the simulations and the laboratory experiment will be described.

### 4.1 Cable Setups

There are five cable setups which will be analyzed in this master thesis. The first setup is when two cables without shield are placed next to each other with no distance between them. The second cable setup is when the two cables with no shield are placed with a distance of 5 cm between them. The third and fourth setup is the same as the first and the second setup but with the shielded cables instead. Accordingly the third case is when two coaxial cables are placed next to each other with no distance between them and the fourth case is when the two coaxial cables have a distance of 5 cm between them. The two conductor cable with common shield is the last cable to test and is the fifth cable setup.

- Cables with no shield and no distance between them.
- Cables with no shield and a distance of 5 cm between them.
- Cables with shield and no distance between them.
- Cables with shield and a distance of 5 cm between them.
- Cable with two conductors and a common shield.

### 4.2 Placing of Cables

There will be an alternation of the placing of the cables to find out the impact of the electric field when the cables are placed next to a grounded girder. The impact of the magnetic field when the cables have different placing with respect to the girder will also be examined, since the girder is made of a material which conducts magnetic flux. The cables will be placed in two different places. In the calculations with Comsol Multiphysics the first placing is when the cables are placed with a distance of 0.5 m to the girder, in the laboratory tests the distance to the girder will be 5 cm. The distance of 0.5 m in the calculations will show how the magnetic field is affected if there were no girder in the setup. There is no possibility to place the cables 0.5 m from the girder in the measurements; 5 cm is used instead to see the influence of the girder. The second placing is when the cables are placed with no distance to the girder in both the calculations and the laboratory experiments.

- Cables placed with a distance of 0.5 m/5 cm to the girder.
- Cables placed with no distance to the girder.

### 4.3 Test Scenario

There will only be one test scenario. Turn on and turn off will not be examined since power electronics equipment usually have a soft turn on and off to avoid transients. The test scenario which will be examined is when the converter is operating in steady state. Steady state in a converter with components which are switching on and off constantly are when the circuit waveforms repeat with a period  $T$ .

---

## 5 Power Electronics

In this chapter will there be an introduction to power electronics and how to control it.

### 5.1 DC/DC-Converter

The converter which will be used during the laboratory experiment is a bidirectional DC/DC-converter. The converter constitutes of a buck converter joint together with a boost converter with a common capacitance and smoothing inductance.

#### 5.1.1 Buck Converter

A buck converter is a step-down converter; it produces a lower output voltage than the input voltage. Figure 5.1 shows a buck converter. When the transistor is conducting the diode is reversed biased, the inductor is storing up energy and the output voltage is equal to the input voltage. In the interval when the transistor is not conducting the diode is forward biased and the output voltage is provided from the inductor. By varying the time the transistor is conducting the output voltage can be controlled. The filter capacitance at the output is usually large to make the output near constant in steady-state [15].

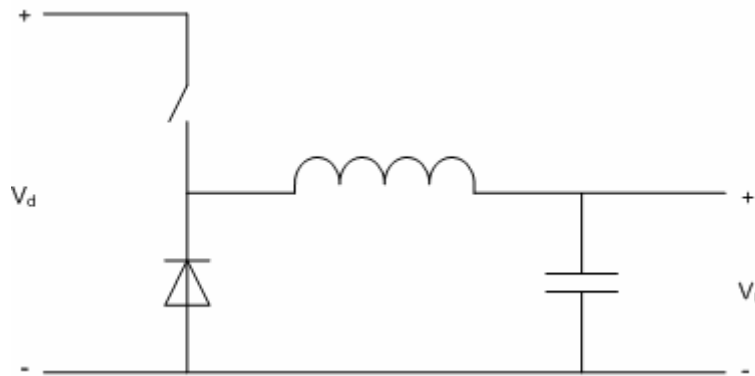

Figure 5.1 - Buck converter.

#### 5.1.2 Boost Converter

The boost converter is a step-up converter, used to step up the output voltage to a higher voltage level than the input voltage. The configuration of a boost converter can be seen in Figure 5.2. While the transistor is conducting the diode is reversed biased and the output is isolated from the input voltage. The diode is forward biased when the transistor is not conducting and the output receives energy from both the inductor and the input. The level of the output voltage is depending on the time the transistor is conducting. To achieve an almost constant output voltage at steady-state the filter capacitance needs to be large [15].

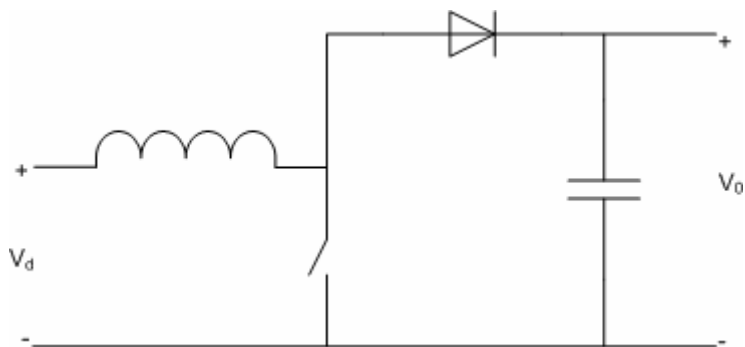

Figure 5.2 - Boost converter.

### 5.1.3 Bidirectional DC/DC-Converter

The configuration of the bidirectional DC/DC-converter can be seen in Figure 5.3. From the left it is a buck converter which steps down the voltage. The buck converter consists of the upper transistor and the lower diode. The boost converter can be seen from the right of the DC/DC-converter; it consists of the lower transistor and the upper diode. The ratings of the bidirectional DC/DC-converter can be seen in Table 5.1.

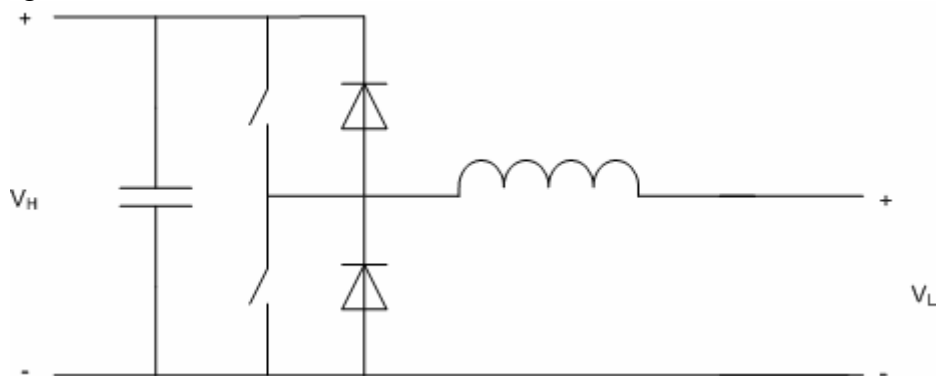

Figure 5.3 - Bidirectional DC/DC-Converter.

Table 5.1 - Ratings of DC/DC-Converter.

Maximum Current	330 A
Minimum Input Voltage	10 V
Maximum Input Voltage	500 V
Maximum Output Voltage	650 V and $\geq U_{in}$
Maximum Power	160 kW
Efficiency	95 %

### 5.1.4 Control of DC/DC-Converter

The converter is controlled by pulse width modulation, PWM. The output voltage level will be decided by the conduction time of the transistors. The switching frequency is constant in PWM switching; the switching frequency signal is compared with a control voltage. The transistors are conducting when the voltage control signal is higher than the switching signal. There are two operations modes of DC/DC-converters, continuous conduction mode and discontinuous conduction mode. The converter is in discontinuous conduction mode when the inductor current is zero at the end of the off period. The duty ratio is the ratio of the conduction time, the expression can be found in (5.1).

$$D = \frac{t_{on}}{T_s} \quad (5.1)$$

where  $D$  is the duty ratio,  $T_s$  is the period time of the switching frequency and  $t_{on}$  is the time the transistor is conducting. For a buck-boost converter in continuous conduction mode the voltage relation to the duty ratio can be found in (5.2).

$$\frac{V_L}{V_H} = \frac{D}{1-D} \quad (5.2)$$

---

## 6 Calculations

In this chapter the setup and results of calculations of the electric and magnetic fields is presented. The calculations have been done in the software Comsol Multiphysics version 3.3. There has been simplifications made during the calculations, the simplifications and the setup will be described in the beginning of this chapter. There will be one subchapter for each cable type, where the result of each cable will be presented. In the end of the chapter there will be a discussion of the calculations and the result of the calculations will be stated.

### 6.1 Simplifications

There are some simplifications made to the calculations. The nominal cross-section area of the conductor will not be used in the calculations; instead the conductor area is calculated with the maximum diameter of the conductor. This simplification neglects the fill factor of the conductor, and assumes that the conductor is a solid copper conductor with circular cross-section. The conductor is assumed to be made of copper; the conductivity of copper is  $5.8 \cdot 10^7$  S/m. The simplifications made to the shield are to assume that the shield is a copper tube instead of a braid of copper. The shield is also assumed to be made of copper. Since the shield is assumed to be a copper tube instead of a braid, there will be no electric field outside the shield. Therefore there will only be electric field calculations for the unshielded cable type. The calculations are simplified by not using data from a drive cycle or at a current with ripple during the calculations, there will just be a constant current density. Since the surrounding field has the same distribution in z-direction there is no need for a 3D cavity. Using a 2D cavity minimizes the problem which needs to be solved.

### 6.2 Setup and Analysis

#### 6.2.1 Setup of Calculations

The application mode used in Comsol Multiphysics is a 2D mode. For the unshielded cables there are both an electrostatic and a magnetostatic problem solved. When solving an electrostatic problem, the “Electrostatics, Generalized” module is used. It can be found in the “AC/DC Module”, in the “Statics” folder. For all magnetic field calculations the used application mode is “Perpendicular Induction Currents, Vector Potential”; it can be found in the “AC/DC Module” in “Statics” under “Magnetostatics”.

The cables are placed next to each others in the first case and with a distance of 5 cm between them in the second case. The cables are placed in two different locations; with a distance of 0.5 m to an iron I-girder and next to the iron girder. The girder is assumed to have a height of 20 cm and a thickness of 1 cm.

#### 6.2.2 Setup of Electric Field Calculations

In the sub domain settings the material constants is set. The setup of the sub domain settings and the boundary conditions can be seen in Figure 6.1. The sub domain settings are where the material constants are set for the cavities which are used in the calculations. In the boundary settings is the conditions set for the boundaries of the cavities. The differential equations are solved in a large box, which is surrounding the cables and the girder. Comsol Multiphysics require the large box to be able to solve the problem. If the large box was not there the problem would only be solved inside the cables, since Comsol Multiphysics only solves the problem inside the drawn cavities. The sub domain settings are set to copper for the conductor, REMS for the jacket, iron

for the girder and air for the surroundings. The constants for each of the material can be seen in Table 6.1. The boundaries of the surrounding box are set to electric insulation, the boundaries of the girder are set to ground and the boundaries of the jacket of the cables are set to continuity. The upper conductors boundaries are set to an electric potential of 300 V and the lower conductors boundaries are set to an electric potential of -300 V, which gives a potential difference of 600 V.

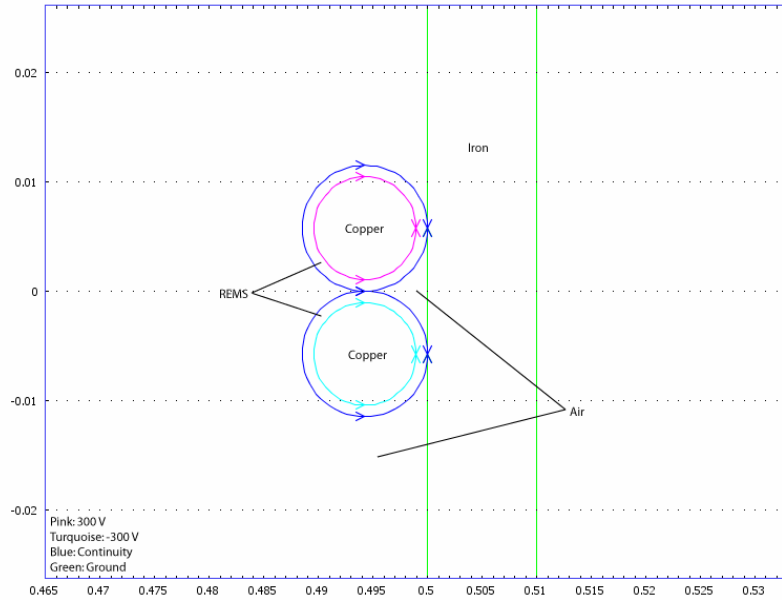

Figure 6.1- Sub domain settings and boundary conditions for electric field calculations.

Table 6.1 - Material constants for electric field calculations.

Material	Conductivity [S/m]	Relative permittivity
Air	0	1
Copper	$5.998 \cdot 10^7$	1
Iron	$1.12 \cdot 10^7$	1
REMS	0	4.79

### 6.2.3 Setup of Magnetic Field Calculations

The setup of the sub domain, the material constants of the cavities, in the calculations can be seen in Figure 6.2, the surrounding box is not seen in the figure. The cables and the girder are surrounded by a large box, the field equations is only solved inside the box. In the sub domain settings the conductors and the shields are set to copper, the insulation and jacket is set to REMS, the I-girder is set to iron and the surrounding is set to air. The conductivity and the relative permeability of the materials mentioned above can be seen in Table 6.2. The copper conductors have an external current density. The current density is calculated with the following formula

$$J = \frac{I}{A} = \frac{I}{\pi r^2}. \quad (6.1)$$

By using (6.1) the current density of a conductor of 50 mm<sup>2</sup>, which is conducting a current of 200 A is calculated to have a current density of  $2.9 \cdot 10^6$  A/m<sup>2</sup>. The upper conductor is set to have a current density of  $2.9 \cdot 10^6$  A/m<sup>2</sup> and the lower conductor is set to have a current density of  $-2.9 \cdot 10^6$  A/m<sup>2</sup>. The boundary conditions are set to continuity for all boundaries except for the boundaries of the surrounding box, which is set to magnetic insulation.



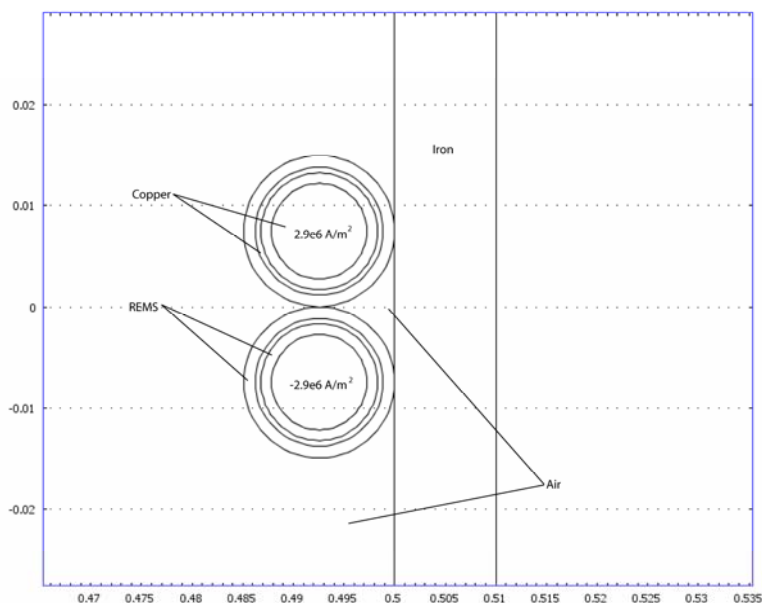

**Figure 6.2 - Sub domain settings of the calculations for magnetostatics.**

**Table 6.2 - Sub domain settings for the materials used in the calculations.**

<i>Material</i>	<i>Conductivity [S/m]</i>	<i>Relative permeability</i>
Copper	$5.998 \cdot 10^7$	1
Air	0	1
Iron	$1.12 \cdot 10^7$	4000
REMS	0	1

### 6.2.4 Analysis Procedure

A surface plot of the electric/magnetic field will be shown for each setup. The electric field intensity and the magnetic flux density shown in the surface plot will be examined by using the cross-section plot tool. Both a vertical and horizontal cross-section plot will be used. The horizontal cross-section plot is made in the middle between the cables and the vertical cross-section plot is made in the centre of the two cables. Figure 6.3 shows an outline of the cross-section plots. The cross-section plot tool generates a graph of the magnetic flux, where zero in the plot is where the line is started. In these cases the horizontal plot is started from the left and the vertical plot is started from the top.

In the calculations of the electric field there is a big difference in the top value of the horizontal and the vertical cross-section plot. This is because the vertical cross-section line is not exact in the middle of the cables, it is a little to the left. Since the field is decreasing very fast in the x-direction the top value of the vertical plot is much decreased. Even though the line is just a very little bit to the left it makes a big difference in the result. If the line would have been placed where it should, in the centre of the cables, the top value of the horizontal and the vertical plot would be the same. This can also be seen in the results of the calculations of the magnetic fields, but the magnetic field is not decreasing as fast as the electric field. Therefore the slip of the line is not affecting the results as much as in the calculations of the electric field.

A comparison of the peak of the field intensity, in the horizontal plot, for cables placed next to each others and with a distance between them is misleading. The cables placed with no distance between them have the highest field between them. The peak of the field for the cables placed with a distance between them has the highest field on the

jacket of the cable, and not in the distance between them, where the vertical cross-section is made.

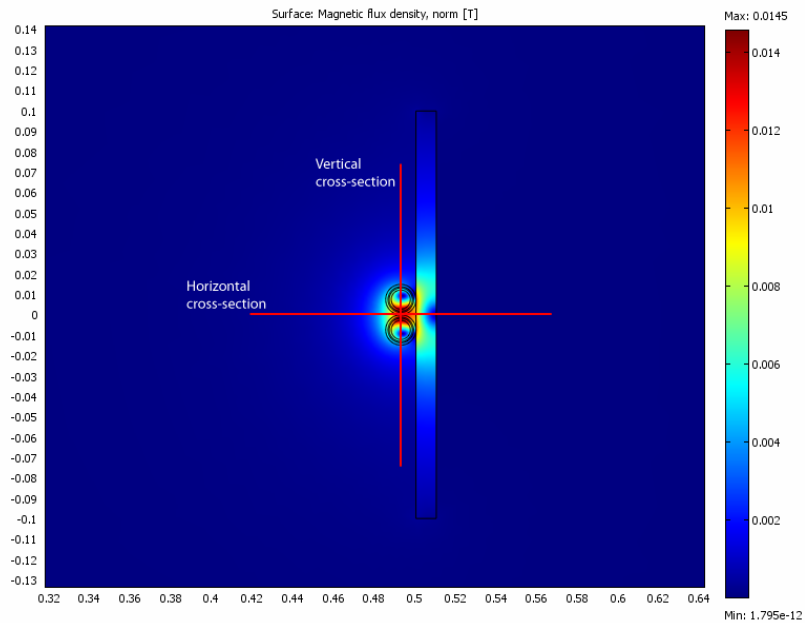

Figure 6.3 - Outline of cross-section plot.

### 6.3 Calculations of the Electric Field

In this chapter the results of the calculations of the electric field for unshielded cables are found. In the end of the chapter there is a discussion of the results of the electric field calculations.

#### 6.3.1 Results of Unshielded Cables

The electric field of the cables are at first examined when the cables are placed with a distance of 0.5 m to the girder and secondly when the cables are placed next to the girder. In the end of the subchapter are the results of the unshielded cables presented.

##### Placing with a Distance to the Girder

The distribution of the electric field intensity is shown in Figure 6.4; the cables are placed with no distance between them and a distance of 0.5 m to the grounded girder. The field intensity is highest at the point where the cables meet. The level of the field will be examined with a horizontal and a vertical cross-section plot.

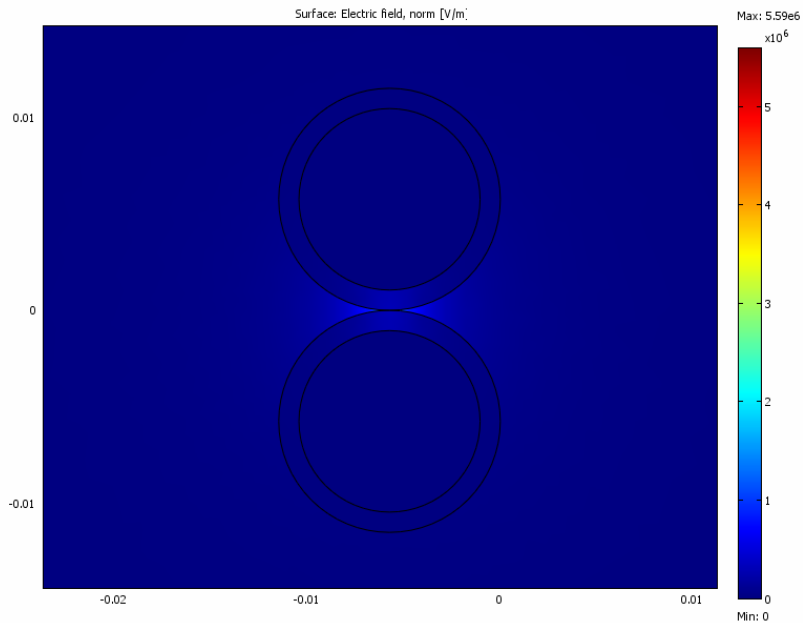

**Figure 6.4 - Electric field of unshielded cables placed with no distance between them and 0.5 m to the grounded girder.**

Figure 6.5 shows a horizontal cross-section plot of the electric field intensity when the cables are placed with no distance between them. The electric field has a peak between the cables, and reaches 1950 kV/m. 4 cm from the jacket of the cable has the field decreased to 1.60 kV/m

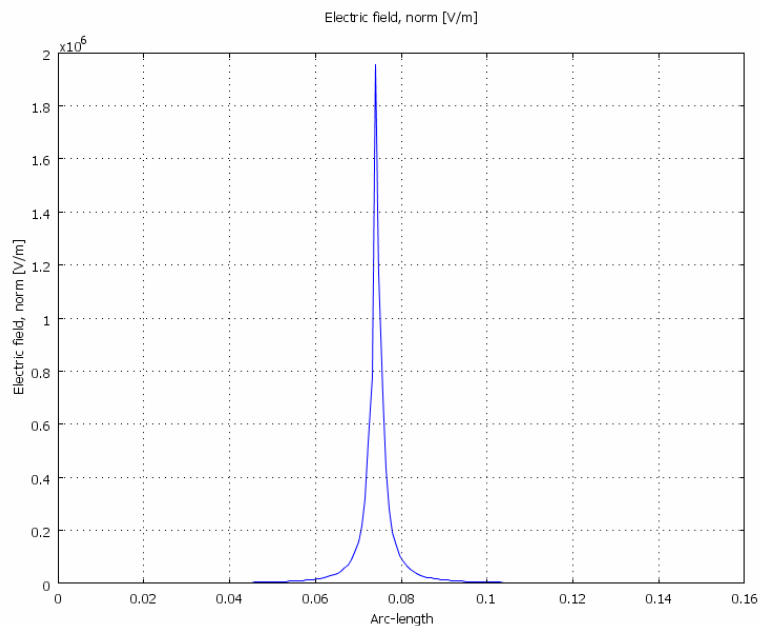

**Figure 6.5 - Horizontal cross-section plot of the electric field intensity of two cables placed with no distance between them.**

The electric field intensity of two cables placed with no distance between them is shown in Figure 6.6; it is a vertical analysis of the electric field intensity. The highest electric field is found between the cables, it reaches 278 kV/m. The area where the intensity is zero in the plot is in the conductors. The lower peaks which can be seen in the plot are found right outside the jacket of the cables. 4 cm from the jacket of the cable the field intensity has decreased to 1.30 kV/m.

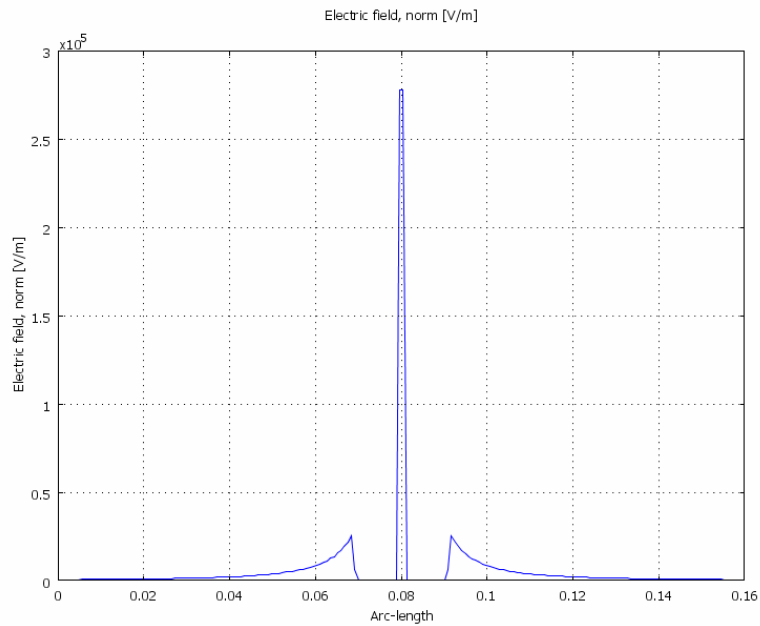

**Figure 6.6 - Vertical cross-section plot of the electric field intensity of two cables placed with no distance between them.**

Figure 6.7 shows a surface plot of the electric field intensity of two cables placed with a distance of 5 cm between them and a distance of 0.5 m to the grounded girder. As seen in the plot the field is spread between the cables when there is a distance between them. The highest field is found on the jacket of the cable. An examination with a horizontal and vertical cross-section plot will follow.

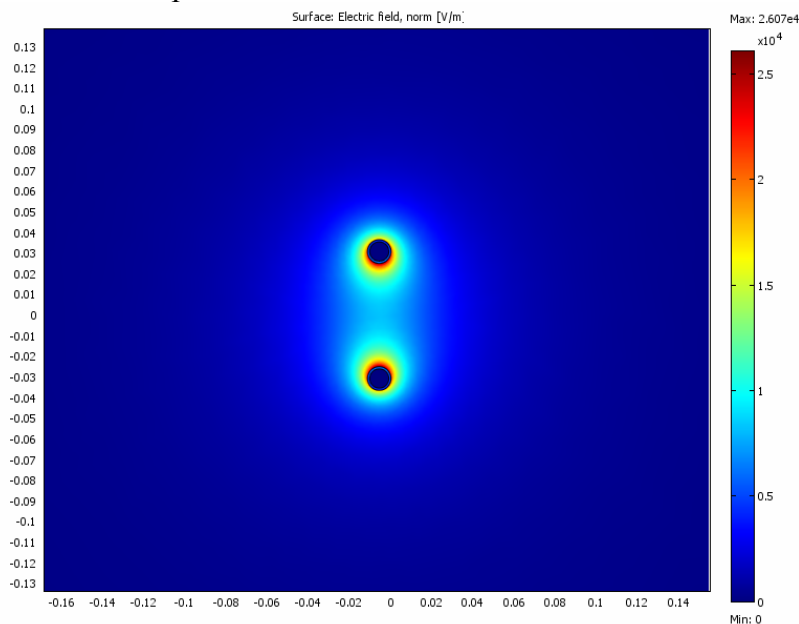

**Figure 6.7 - Electric field intensity of unshielded cables placed with a distance of 0.05 m between them and 0.5 m to the grounded girder.**

Figure 6.8 shows a horizontal cross-section plot of the electric field intensity of two cables with a distance of 0.05 m between them. The peak of 8.34 kV/m is between the cables. 4 cm from the jacket of the cables the field has decreased to 2.50 kV/m.

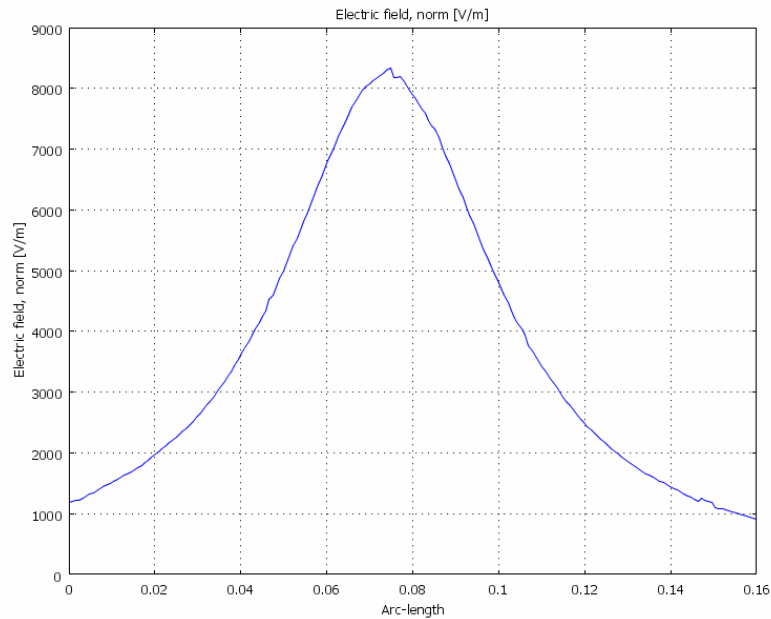

**Figure 6.8 - Horizontal cross-section plot of the electric field intensity of two cables placed with a distance of 0.05 m between them.**

The electric field intensity of two cables placed with a distance of 0.05 m between them is shown in Figure 6.9, as a vertical cross-section plot. The highest peaks, which reach 24.1 kV/m is on the jacket of the cable, the second peaks are on the opposite side of the cable, also on the jacket of the cable. The dip between the two highest peaks is in the distance between the cables, the areas where the field intensity are zero is in the conductor of the cables. At a distance of 4 cm from the jacket of the cables the field intensity has decreased to 1.53 kV/m.

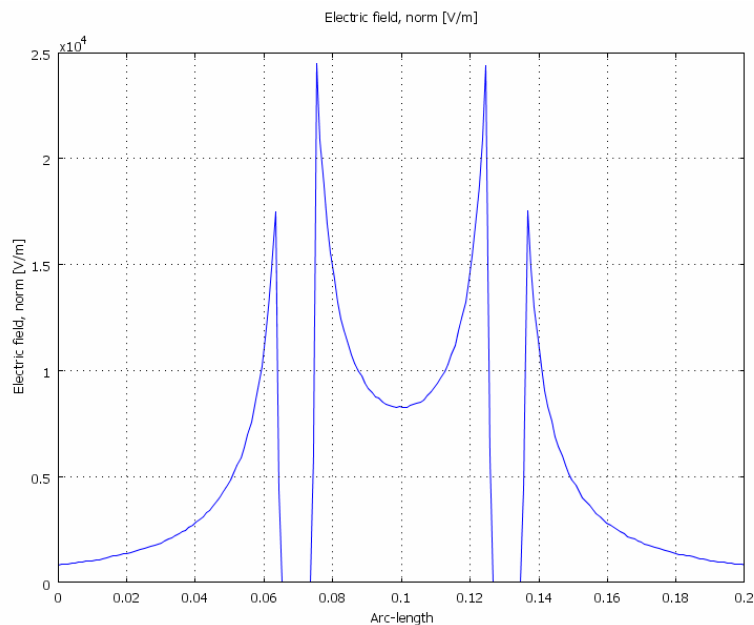

**Figure 6.9 - Vertical cross-section plot of the electric field intensity of two cables placed with a distance of 0.05 m between them.**

### Placing with No Distance to the Girder

Figure 6.10 shows a surface plot of the electric field intensity of two cables placed with no distance between them and next to a grounded girder. The highest field intensity is found where the cables meet and where the cables meet the girder.

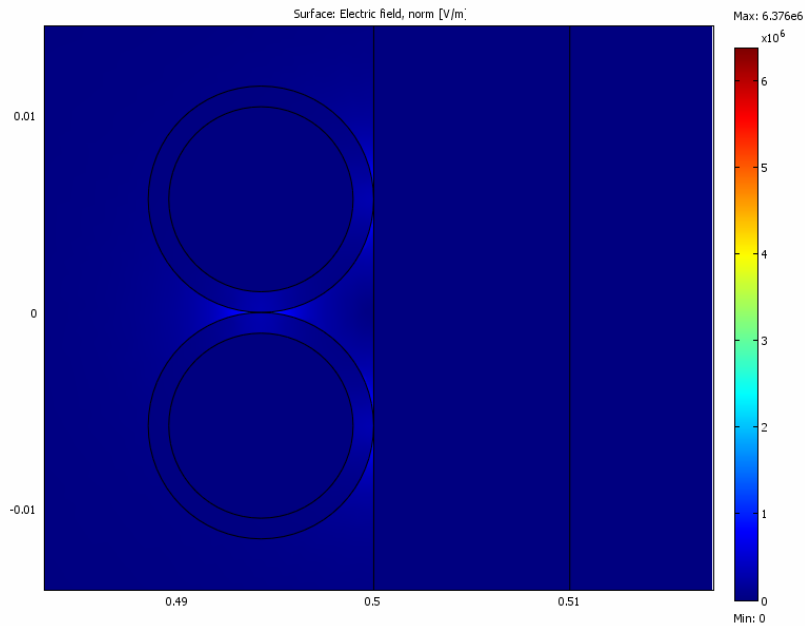

**Figure 6.10 - Electric field intensity of unshielded cables placed with no distance between them and no distance to the grounded girder.**

Figure 6.11 shows a horizontal cross-section plot of the electric field intensity of two cables placed with no distance between them and placed next to a grounded girder. The peak of the field intensity is found between the cables, and reaches 1950 kV/m. 4 cm from the jacket of the cables is the field intensity decreased to 0.84 kV/m. In the grounded girder and on the opposite side of the girder is the field intensity zero.

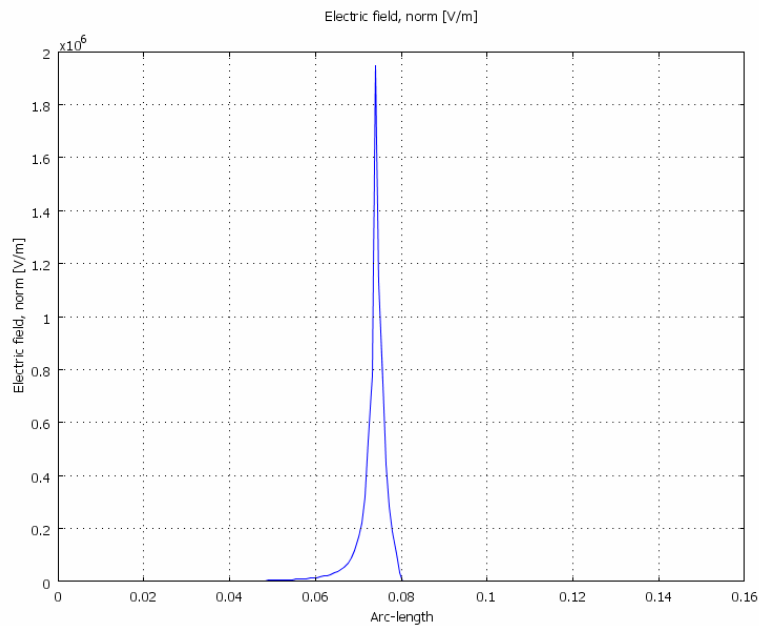

**Figure 6.11 - Horizontal cross-section plot of the electric field intensity of two cables placed with no distance between them and next to a grounded girder.**

The vertical cross-section plot shown in Figure 6.12 shows the electric field intensity of two cables placed next to each others and next to a grounded girder. The peak of the field intensity reaches 278 kV/m and is found between the cables. 4 cm from the jacket of the cables the field intensity is decreased to 0.84 kV/m.

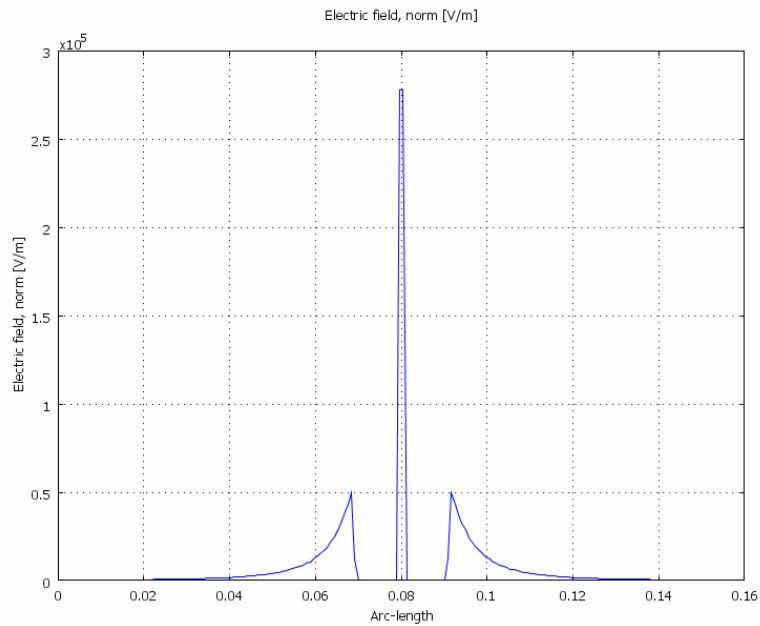

**Figure 6.12 - Vertical cross-section plot of the electric field intensity of two cables placed with no distance between them and next to a grounded girder.**

The electric field intensity of two cables placed with a distance of 0.05 m between them and no distance to the grounded girder is shown as a surface plot in Figure 6.13. The field is at highest at the points where the cables meet the grounded girder.

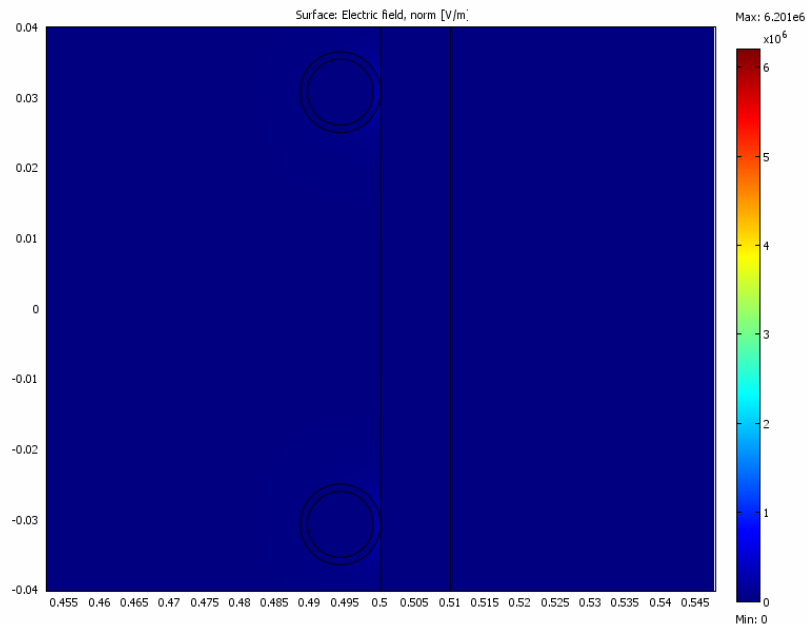

**Figure 6.13 - Electric field intensity of the cables placed with a distance of 0.05 m between them and no distance to the grounded girder.**

The electric field intensity of two cables placed with a distance of 0.05 m between them and placed next to a grounded girder is shown in Figure 6.14, as a horizontal cross-section plot. The peak of the field is found between the cables, and reaches 4.70 kV/m. The field intensity is zero in the girder and on the opposite side of the girder. 4 cm from the jacket of the cables the field has decreased to 1.75 kV/m.

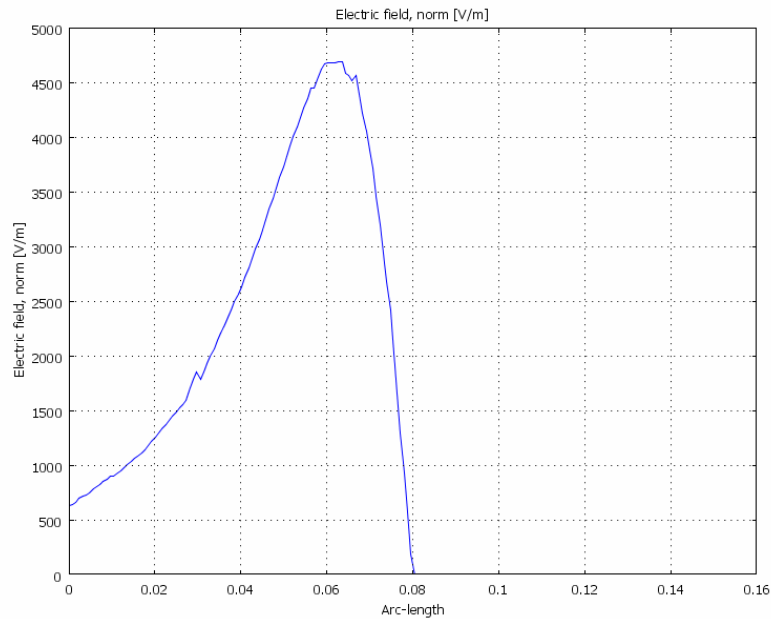

**Figure 6.14 - Horizontal cross-section plot of the electric field intensity of two cables placed with a distance of 0.05 m between them and next to a grounded girder.**

Figure 6.15 shows a vertical cross-section plot of the electric field intensity of the cables when they are placed with a distance of 0.05 m between them and placed next to the grounded girder. The highest peaks are found right outside the jacket of the cables, and they reach 48.4 kV/m. The field intensity is decreased with increasing distance from the cables, 4 cm from the jacket of the cables the field is decreased to 1.35 kV/m.

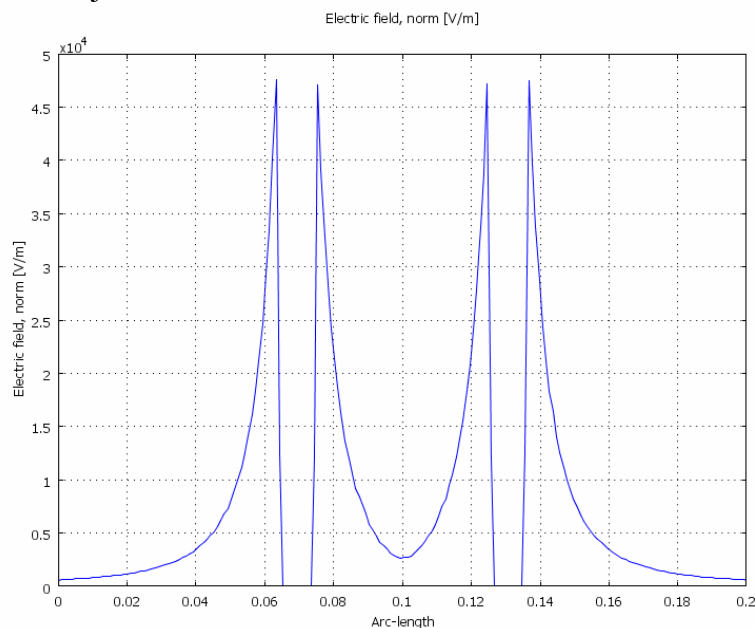

**Figure 6.15 - Vertical cross-section plot of the electric field intensity of two cables placed with a distance of 0.05 m between them and next to a grounded girder.**

### Discussion of Results

The results of the electric field calculations are compiled in Table 6.3. The value of the peak of the field is higher for the cables placed with no distance between them. Comparing the results of the cables with no distance between them and the cables placed with 5 cm between them, when the cables are placed 0.5 m from the grounded girder, shows that the peak value are much higher for the cables placed with no distance



between them. When the cables placed with no distance between them are placed next to the grounded girder the peak value of the field is not changed. The peak value of the field of the cables placed with a distance of 5 cm between is increased when the cables are placed next to the grounded girder. The electric field is zero on the opposite side of the girder when the cables are placed next to the girder. The field 4 cm from the cables is lower for the cables with no distance between them when the cables are placed next to the girder. Placing next to the grounded girder has a positive impact for the cables placed with no distance between them. When the cables with a distance between them are placed next to the grounded girder the vertical values of the electric field is lowered and the horizontal value of the electric field is increased. The increase in the horizontal field is due to the girder which is helping the field to spread in the horizontal direction.

**Table 6.3 - Summarize of the electric field intensity of the unshielded cables.**

<i>Horizontal/ Vertical analysis</i>	<i>Distance between cables [m]</i>	<i>Distance to girder [m]</i>	<i>Peak of field [kV/m]</i>	<i>Field 4 cm from jacket of cable [kV/m]</i>	<i>Field opposite side of girder [kV/m]</i>
H	0	0.5	1950	1.60	-
V	0	0.5	278	1.30	-
H	0.05	0.5	8.34	2.50	-
V	0.05	0.5	24.1	1.53	-
H	0	0	1950	0.84	0
V	0	0	278	0.84	-
H	0.05	0	4.70	1.75	0
V	0.05	0	48.4	1.35	-

## 6.4 Calculations of the Magnetic Field

In this chapter the results of the magnetic fields will be presented, starting with unshielded cables, then shielded cables and last the cable with two conductors with a common shield.

### 6.4.1 Results of Unshielded Cables

First the magnetic flux density is examined when the cables are placed with a distance of 0.5 m from the magnetic girder. Secondly the magnetic flux density is examined when the cables are placed with no distance from the magnetic girder to see the impact of the girder. The result will be discussed in the end of this subchapter.

#### Placing with a Distance to the Girder

Figure 6.16 shows a surface plot of the magnetic flux density of two cables placed with no distance between them and 0.5 m to the magnetic girder. The magnetic flux is highest between the cables.

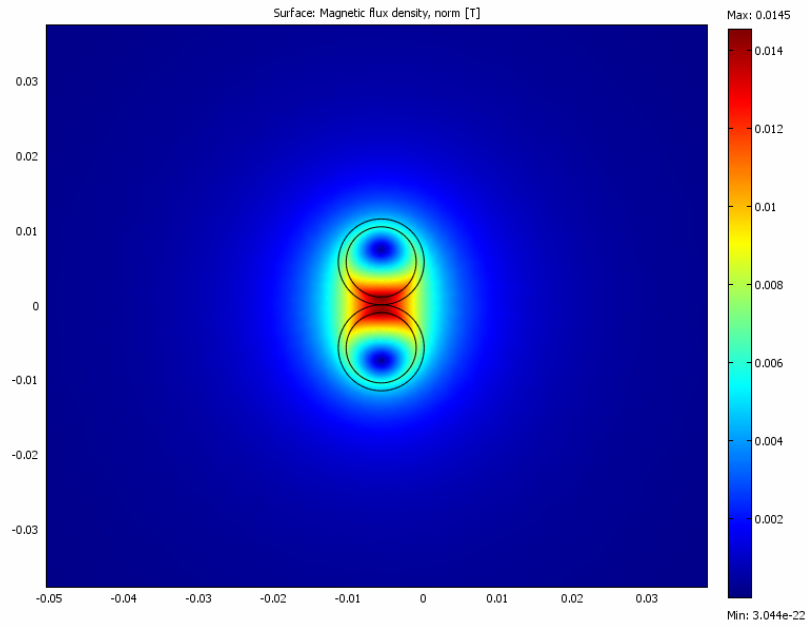

**Figure 6.16 - Magnetic flux density of shielded cables which are placed with no distance between them and 0.5 m to the girder.**

A horizontal cross-section of the magnetic flux density for cables with no distance between them is shown in Figure 6.17. The maximum flux is between the cables, the magnetic flux density decreases with increasing distance to the cables. The cables which have no distance between them have a peak of 14.5 mT between them. Looking at a point 4 cm from the jacket of the cables, the flux has decreased to 0.20 mT.

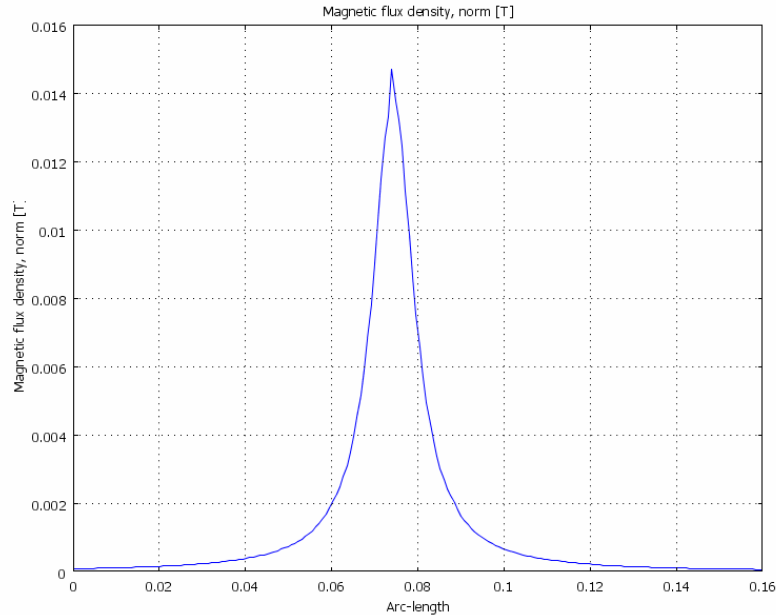

**Figure 6.17 - Horizontal cross-section plot of the magnetic flux density of two cables placed with no distance between them.**

Figure 6.18 shows a vertical cross-section plot of the magnetic flux density of the cables which are placed next to each others. Also here the peak of the flux is between the cables; the peak of the flux reaches 14.0 mT. At a distance of 4 cm from the jacket of the cable the flux has decreased to 0.20 mT.

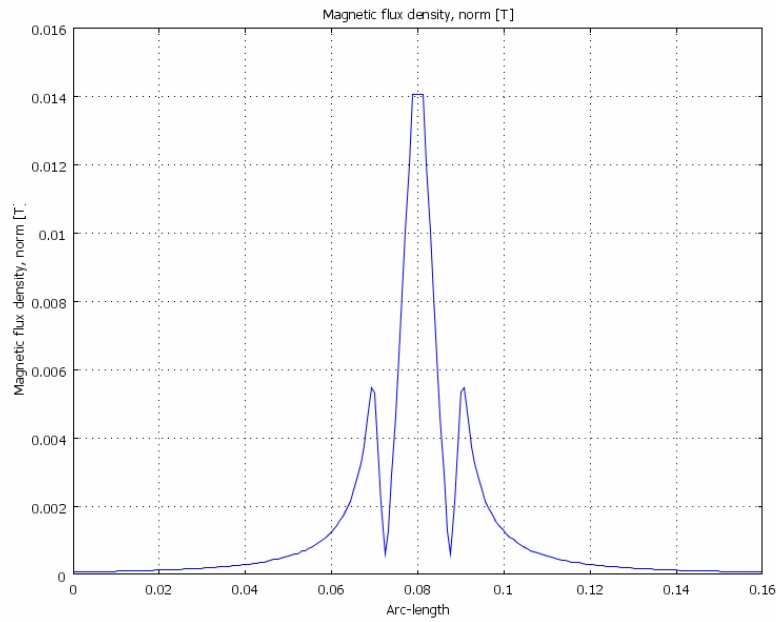

**Figure 6.18 - Vertical cross-section plot of the magnetic flux density of cables with no distance between them.**

The magnetic flux density of two cables placed with a distance of 0.05 m between them and a distance of 0.5 m to the magnetic girder is shown as a surface plot in Figure 6.19. The magnetic flux density is spread between the cables when there is a distance between them.

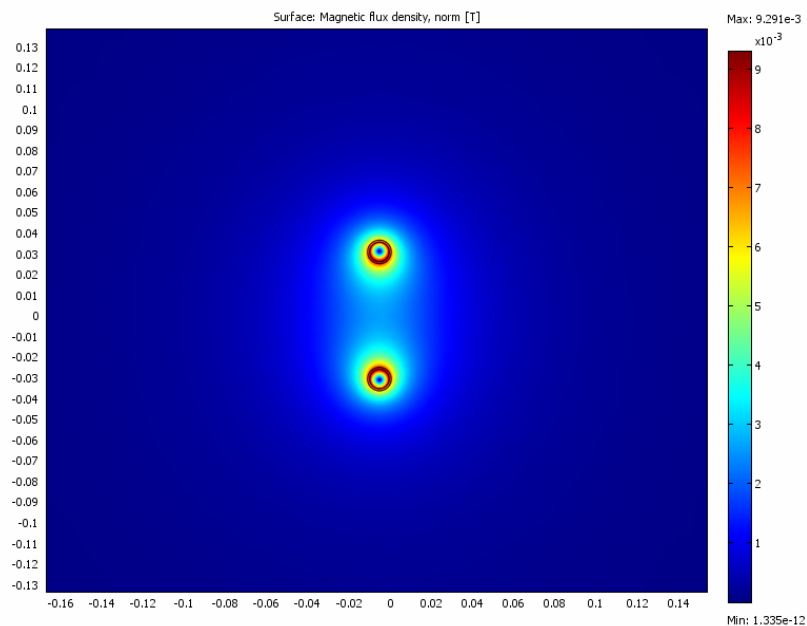

**Figure 6.19 - Magnetic flux density of unshielded cables placed with a distance of 0.05 m between them and 0.5 m to the girder.**

Figure 6.20 shows a horizontal cross-section plot of the magnetic flux density of the cables with a distance of 0.05 m between them. The peak of the magnetic flux of the cables reaches 2.70 mT. At a point 4 cm from the jacket of the cables the flux has decreased to 0.80 mT.

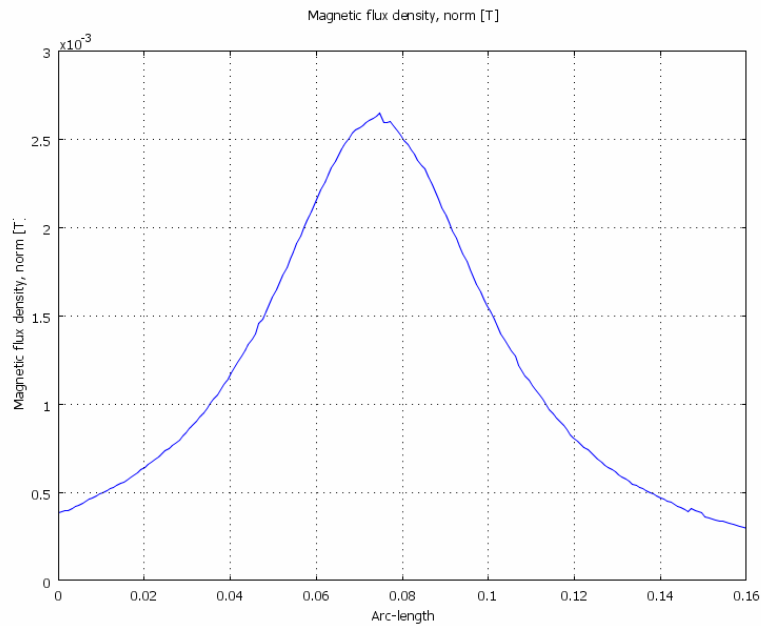

**Figure 6.20 - Horizontal cross-section plot of magnetic flux density of two cables placed with a distance of 0.05 m between them.**

Figure 6.21 is a plot of a vertical cross-section of the magnetic flux density of the cables with a distance between them. Between the two cables the flux is 2.60 mT, it is then increased and the highest flux is found between the jacket and the conductor, it reaches 8.50 mT. The lowest flux is found in the middle of the conductors and then the flux is increased in the jacket. Outside the cable the flux is decreased exponentially and at a distance of 4 cm from the cable the flux is 0.52 mT.

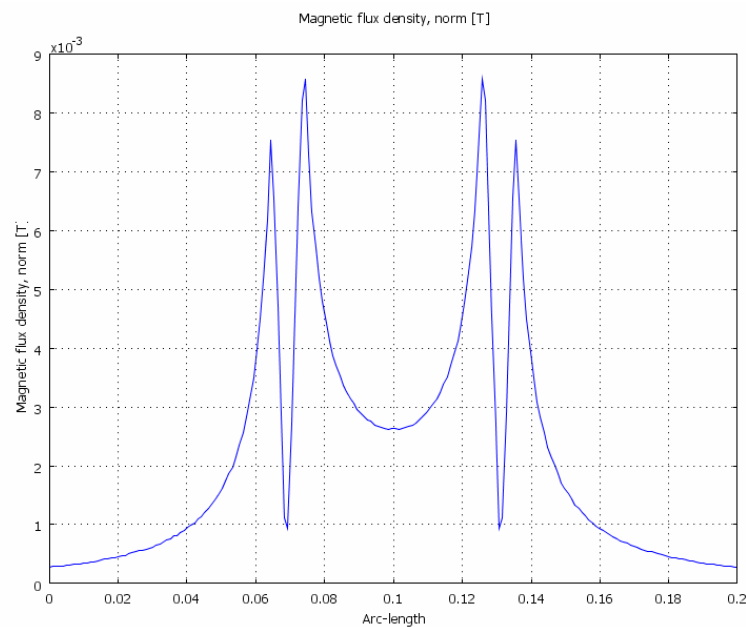

**Figure 6.21 – Vertical cross-section plot of the magnetic flux density of two cables placed with a distance of 0.05 m between them.**

### Placing with No Distance to the Girder

Figure 6.22 shows the magnetic flux density as a surface plot of two cables placed with no distance between them and no distance to the magnetic girder. The magnetic flux density is highest between the cables but it is also high in the magnetic girder.

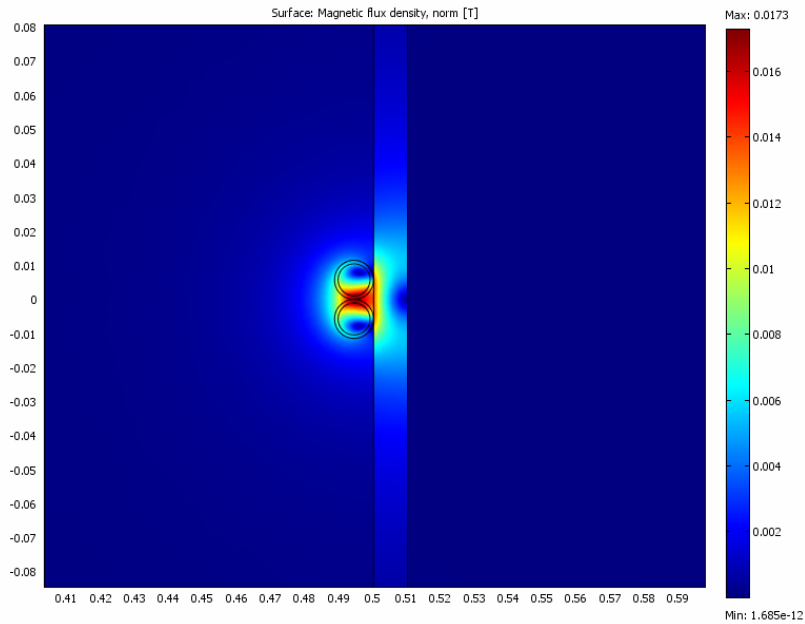

**Figure 6.22 - Magnetic flux density of unshielded cables placed with no distance between them and no distance to the girder.**

Figure 6.23 shows a horizontal cross-section plot of the magnetic flux density when the cables are placed with no distance between each other and next to a magnetic girder. The maximum flux between the cables is 17.5 mT. The flux in the air is decreased and 4 cm from the cables the flux has decreased to 0.34 mT. The flux density is decreased linearly in the girder, on the opposite side of the girder the flux density is zero.

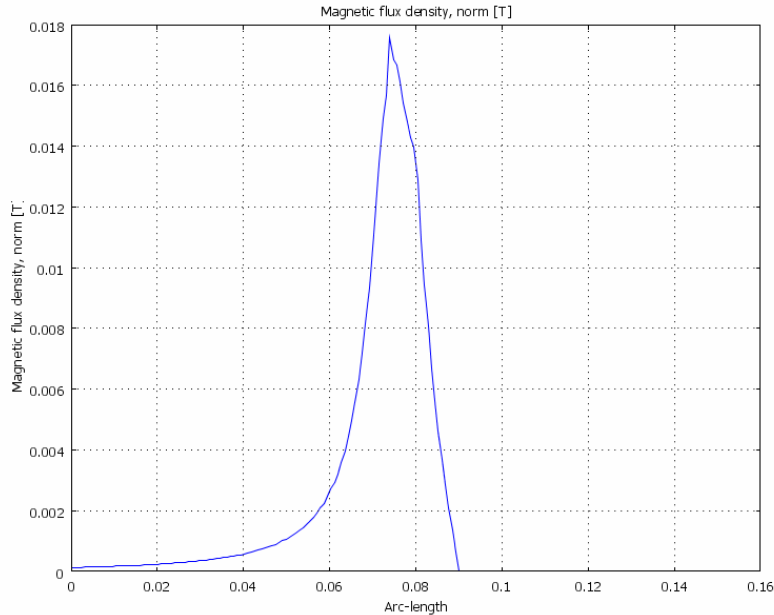

**Figure 6.23 - Horizontal cross-section plot of the magnetic flux density of two cables placed with no distance between them and next to a magnetic girder.**

Figure 6.24 shows a vertical cross-section plot of the magnetic flux density of two cables with no distance between them and placed next to a girder made of magnetic material. The peak of 16.8 mT is in the middle between the two cables. The two lower peaks are in the jacket of the cables, and the exponentially decreasing flux is in the air next to the cables. 4 cm from the jacket of the cables the flux is decreased to 0.36 mT.

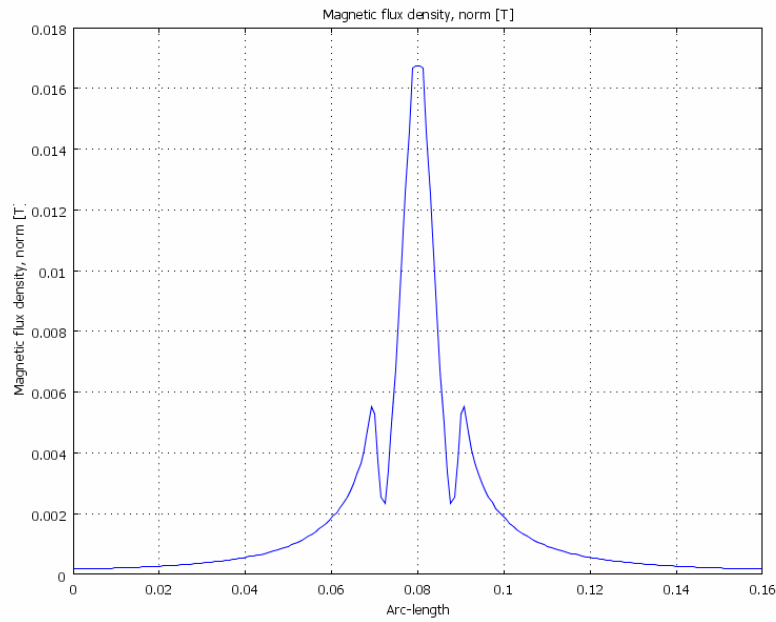

**Figure 6.24 - Vertical cross-section plot of the magnetic flux density of two cables with no distance between them and next to a magnetic girder.**

The magnetic flux density of two cables placed with a distance of 0.05 m between them and next to a magnetic girder is shown in Figure 6.25 as a surface plot. The highest flux is spread in to the magnetic girder.

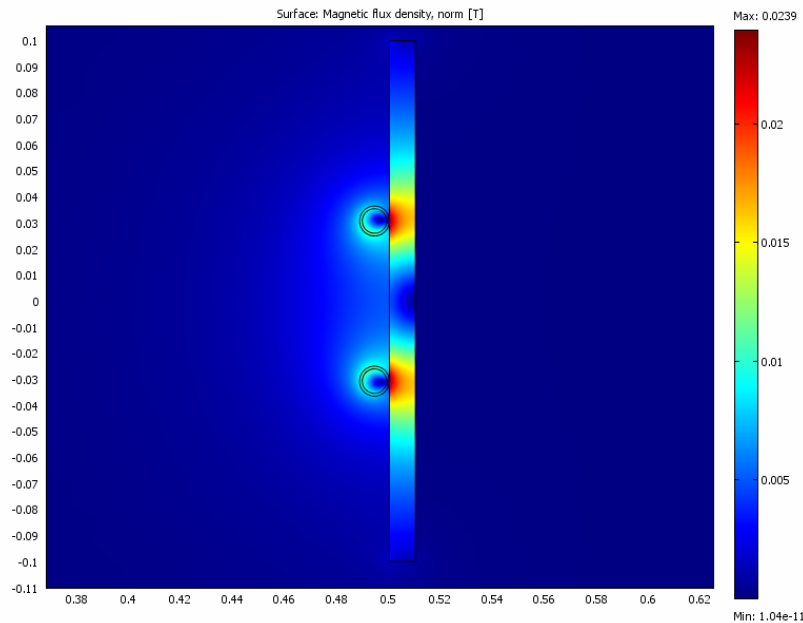

**Figure 6.25 - Magnetic flux density of unshielded cables placed with a distance of 0.05 m between them and no distance to the grounded girder.**

Figure 6.26 shows a horizontal cross-section plot of the magnetic flux density of two cables with a distance of 0.05 m between them placed next to a magnetic girder. The peak of the flux is in the middle between the cables and reaches 4.90 mT at the edge of the girder. At a distance of 4 cm from the cables is the flux density decreased to 1.30 mT. The flux density is decreasing linearly in the girder and has decreased to 0.11 mT on the opposite side of the girder.

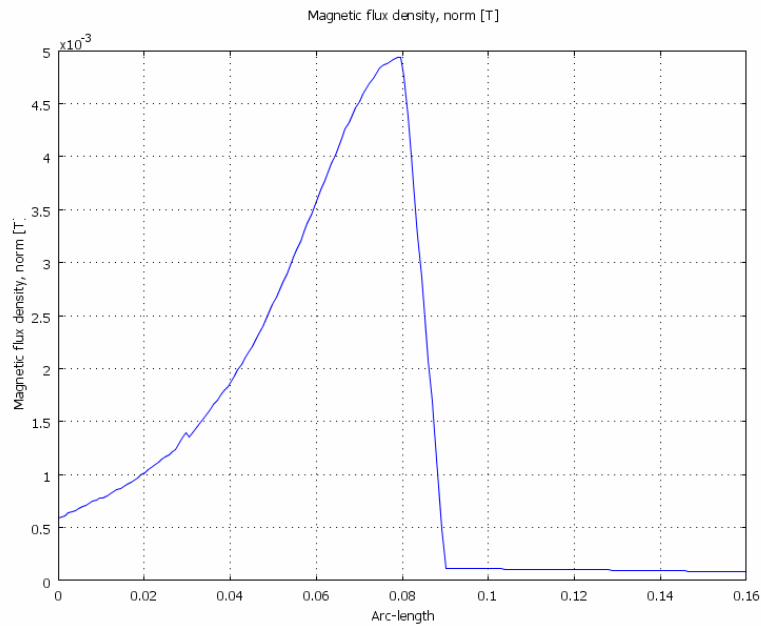

**Figure 6.26 - Horizontal cross-section plot of the magnetic flux density of two cables placed with a distance between them and next to a magnetic girder.**

Figure 6.27 shows a vertical cross-section plot of the magnetic flux density of two cables with a distance of 0.05 m between them placed next to a magnetic girder. The flux in the middle between the cables is 4.80 mT. The maximum flux is in the jacket of the conductor, it is 10.9 mT. At a distance of 4 cm from the cables the flux is decreased to 1.20 mT.

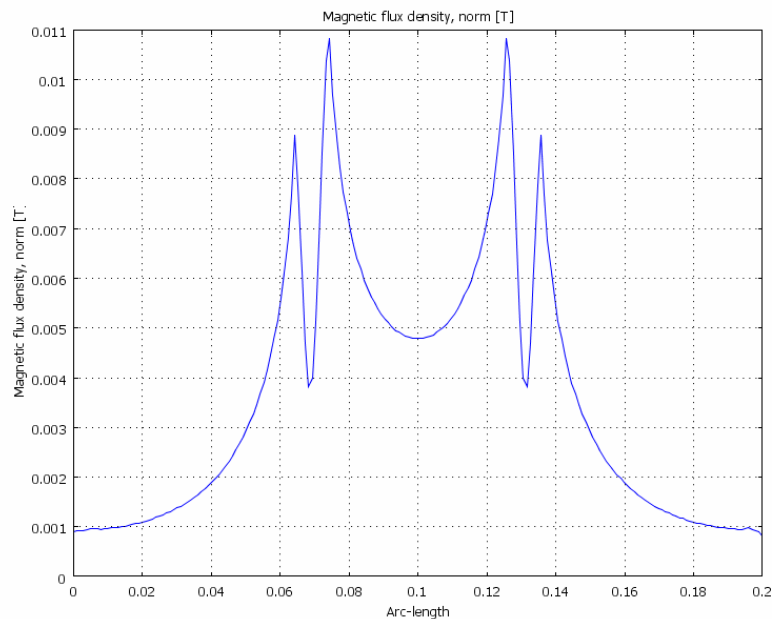

**Figure 6.27 - Vertical cross-section plot of the magnetic flux density of two cables with a distance of 0.05 m between them and placed next to a magnetic girder.**

### Discussion of Results

The results of the calculations of the magnetic fields can be seen in Table 6.4. The peak of the magnetic flux is higher for the cables with no distance between them than for the cables which has a distance of 5 cm between them. The flux is decreasing faster for the cables with no distance between them than for the cables with a distance of 5 cm between them. When the cables are placed next to the magnetic girder the values of the

flux is increased. For the cables with no distance between them there is no flux on the opposite side of the girder.

**Table 6.4 - Summarize of the magnetic flux density of the unshielded cables.**

<i>Horizontal/ Vertical analysis</i>	<i>Distance between cables [m]</i>	<i>Distance to girder [m]</i>	<i>Peak of flux [mT]</i>	<i>Flux 4 cm from jacket of cable [mT]</i>	<i>Flux opposite side of girder [mT]</i>
H	0	0.5	14.5	0.20	-
V	0	0.5	14.0	0.20	-
H	0.05	0.5	2.70	0.80	-
V	0.05	0.5	8.50	0.52	-
H	0	0	17.5	0.34	0
V	0	0	16.8	0.36	-
H	0.05	0	4.90	1.30	0.11
V	0.05	0	10.9	1.20	-

### 6.4.2 Results of Shielded Cables

In this subchapter the results of the calculations of the shielded cables with different placing are presented. The results when the cables are placed 0.5 m from the magnetic girder are presented first, and then is the results when the cables are placed next to the magnetic girder presented. The results are followed by a discussion of the results.

#### Placing with a Distance to the Girder

The magnetic flux density of the shielded cables when they are placed with no distance between them is shown in Figure 6.28 as a surface plot. The highest magnetic flux density is found between the cables.

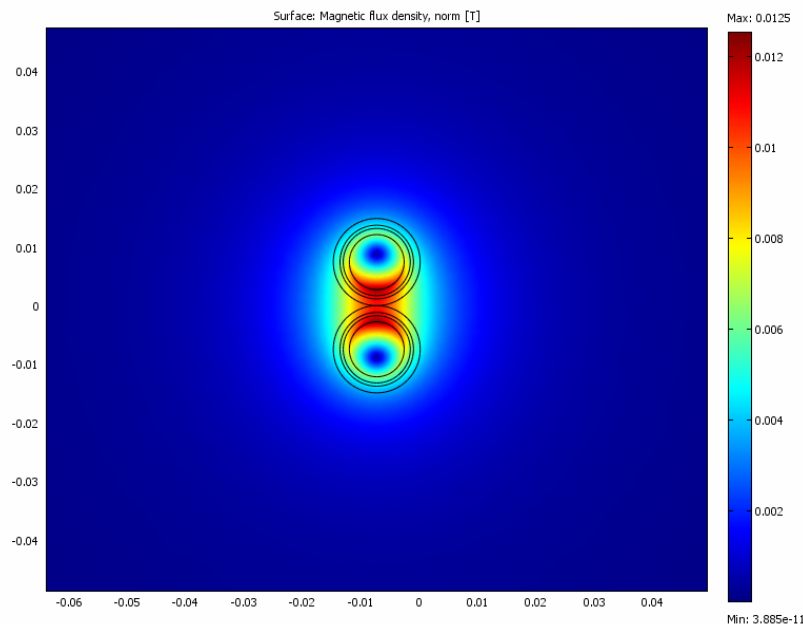

**Figure 6.28 - Magnetic flux density of shielded cables placed with no distance between them and a distance of 0.5 m to the magnetic girder.**

A horizontal cross-section plot of the magnetic flux density of the shielded cables with a distance of 0.5 m to a magnetic girder can be seen in Figure 6.29. The peak of the flux is between the cables, the peak is 11.6 mT. The flux decreases with increasing distance to the cables. 4 cm from the jacket of the cables the flux has decreased to 0.25 mT.



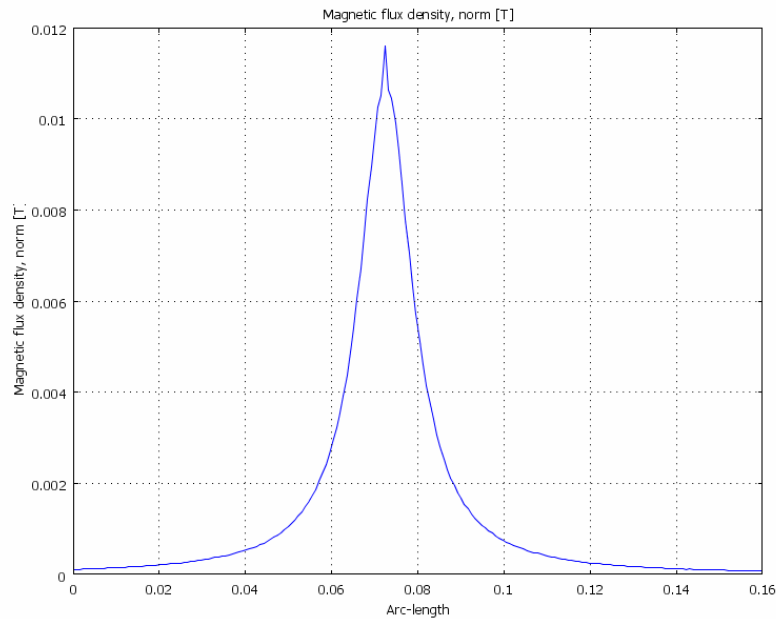

**Figure 6.29 - Horizontal cross-section plot of the magnetic flux density of two shielded cables placed with no distance between them.**

In Figure 6.30 shows a vertical cross-section plot of the magnetic flux of two shielded cables placed next to each others. The peak of the flux is in the insulation between the conductor and the shield; it reaches 12.3 mT. The second peak in the plot reaches 6.00 mT and is also in the insulation between the conductor and the shield. 4 cm from the jacket of the cable the flux is decreased to 0.20 mT.

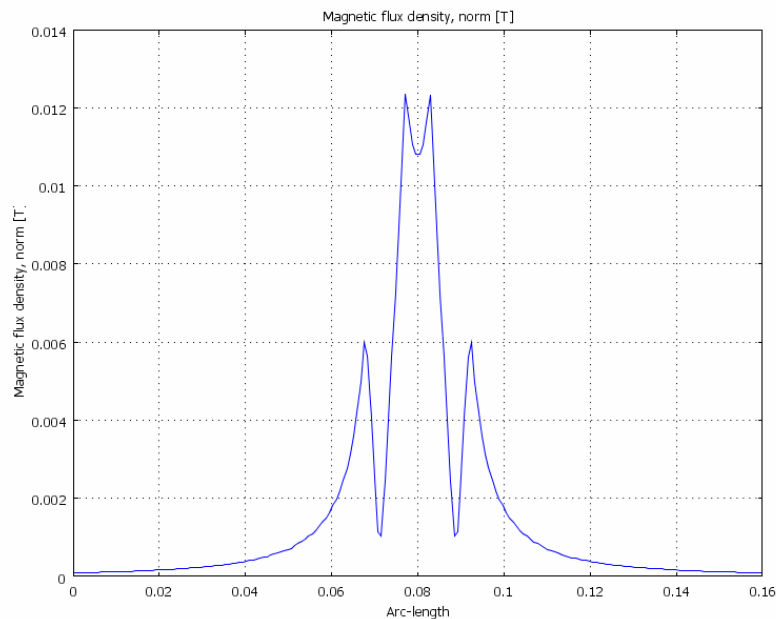

**Figure 6.30 - Vertical cross-section plot of the magnetic flux density of two shielded cables placed with no distance between them.**

Figure 6.31 shows a surface plot of the magnetic flux when the shielded cables are placed with 0.05 m between them and 0.5 m to the girder made of magnetic material. The highest flux is found in the insulation of the cables, the flux is spread between the cables.

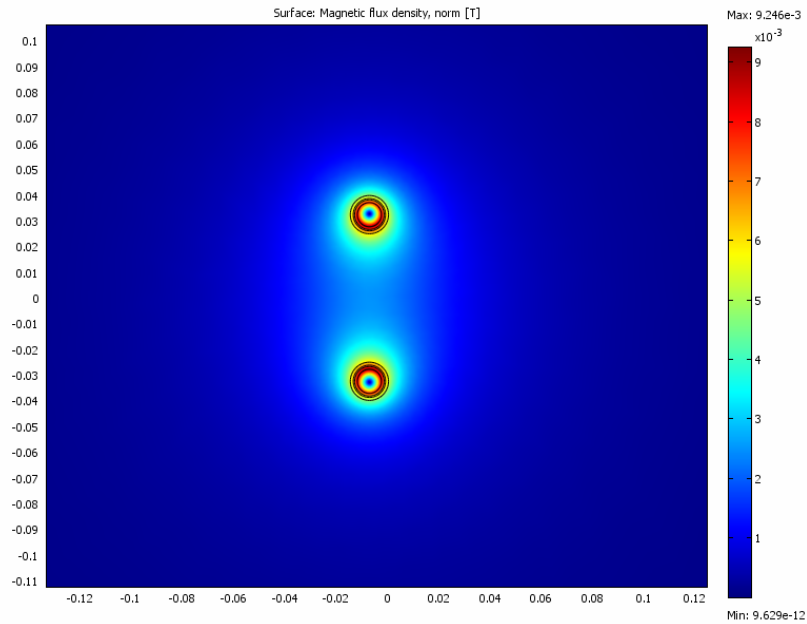

**Figure 6.31 - Magnetic flux density of shielded cables placed with a distance of 0.05 m between them and a distance of 0.5 m to the magnetic girder.**

The magnetic flux density of the shielded cables with a distance between them and placed 0.5 m from the magnetic girder is shown in Figure 6.32 as a horizontal cross-section plot. The peak of the flux is 2.50 mT; the peak is in the middle between the two cables. The flux is then decreasing with the increasing distance to the cables and at 4 cm from the jacket of the cables the flux has decreased to 0.78 mT.

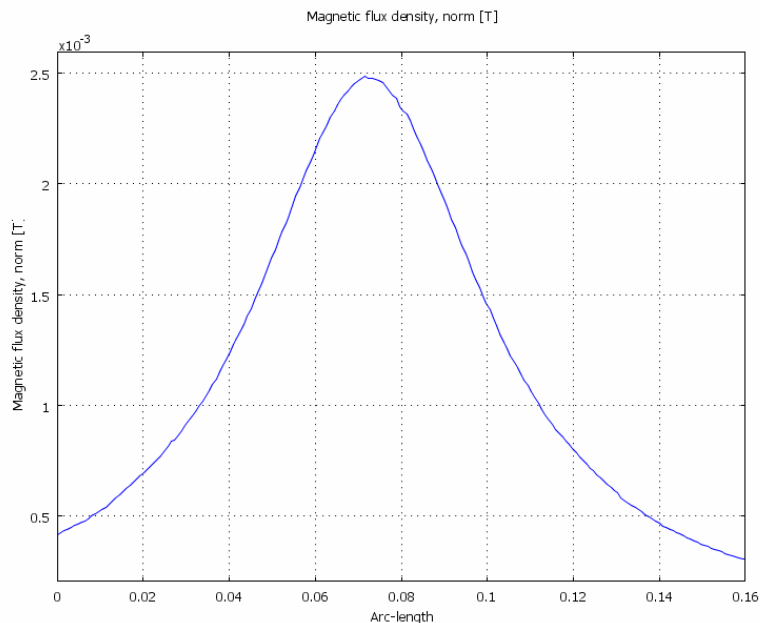

**Figure 6.32 - Horizontal cross-section plot of the magnetic flux density of two shielded cables placed with a distance of 0.05 m between them.**

The flux density of the shielded cables placed with a distance between them can be seen in Figure 6.33, which is a vertical cross-section plot of the magnetic flux density. The maximum flux density of the two cables is at the edge of the conductors, where it reaches 9.00 mT. The second peak of the flux, which is shown in the plot, is also on the edge of the conductors, on the opposite side, it reaches 7.20 mT. The flux is decreasing with the distance, 4 cm from the jacket of the cable the flux has decreased to 0.50 mT.

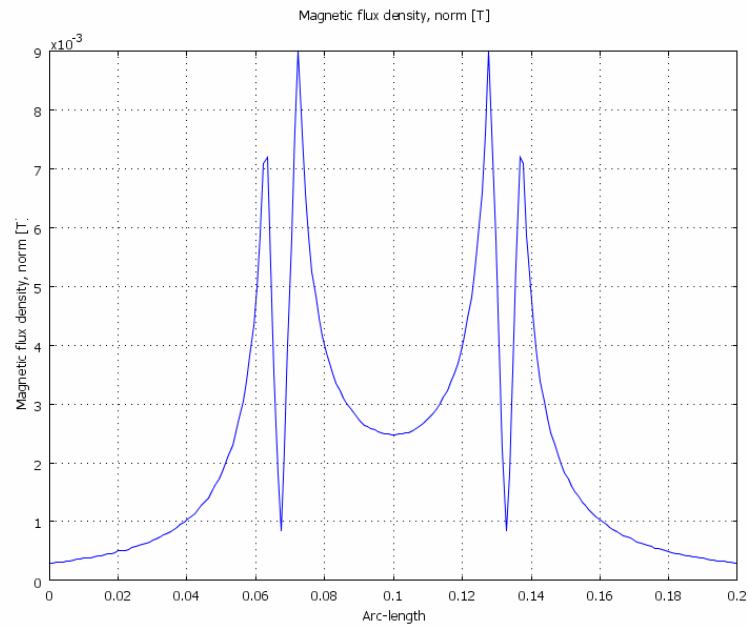

**Figure 6.33 - Vertical cross-section plot of the magnetic flux density of two shielded cables with a distance of 0.05 m between them.**

### Placing with No Distance to the Girder

The magnetic flux density of the shielded cables with no distance between them and no distance to the magnetic girder is shown as a surface plot in Figure 6.34. The highest field is found between the cables and is also spread into the girder.

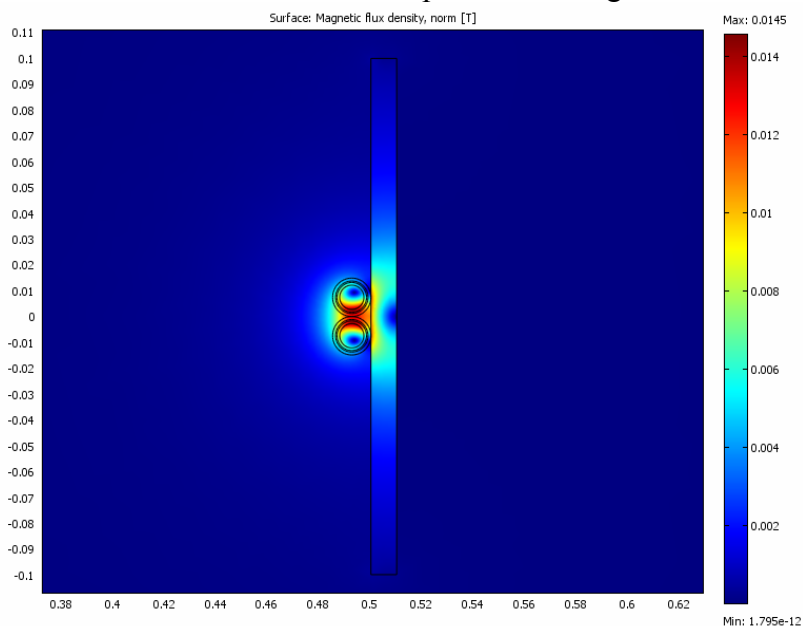

**Figure 6.34 - Magnetic flux density of shielded cables placed with no distance between them and no distance to the girder.**

Figure 6.35 shows the magnetic flux density of the shielded cables placed next to each others and next to the magnetic girder, in a horizontal cross-section plot. The peak of the flux, of 14.0 mT, is between the cables. The flux is decreasing with increased distance to the cables, in the girder the field is decreasing linearly and on the opposite side of the girder, from the cables, the flux is zero. In the air the flux is decreasing exponentially and 4 cm from the jacket of the cables the flux has decreased to 0.39 mT.

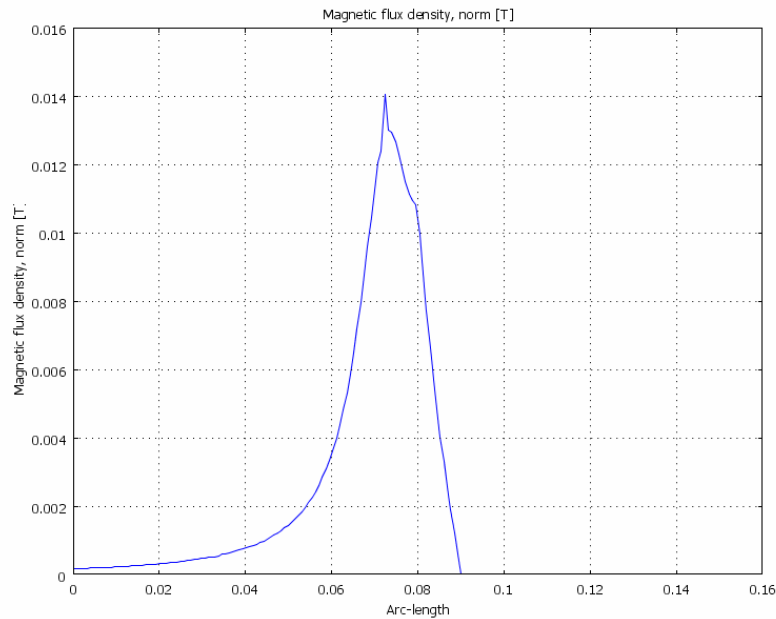

**Figure 6.35 - Horizontal cross-section plot of the magnetic flux density of two shielded cables with no distance between them and placed next to a magnetic girder.**

Figure 6.36 shows a vertical cross-section plot of the magnetic flux density of shielded cables which have no distance between them and which are placed next to a magnetic girder. There are two high peaks of the flux in the plot, they reach 14.4 mT and they are in the insulation of the cables. The dip between the peaks is in the jacket and the shield of the two cables which are placed next to each others. The flux is at lowest in the conductors and the second peaks are in the insulation. The flux is decreasing exponentially in the air outside the cables. In the air, 4 cm from the jacket of the cables, the flux has decreased to 0.41 mT.

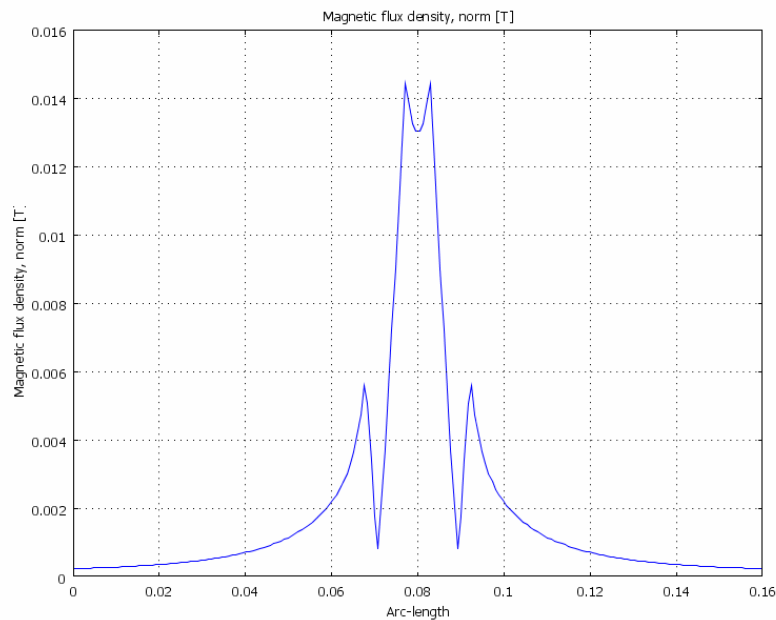

**Figure 6.36 - Vertical cross-section plot of the magnetic flux density of two shielded cables with no distance between them and placed next to a magnetic girder.**

The magnetic flux of the shielded cables, which are placed with a distance of 0.05 m between them and next to a magnetic girder, is shown as a surface plot in Figure 6.37.

The highest flux is found in the insulation of the cables, the flux is not spread into the girder.

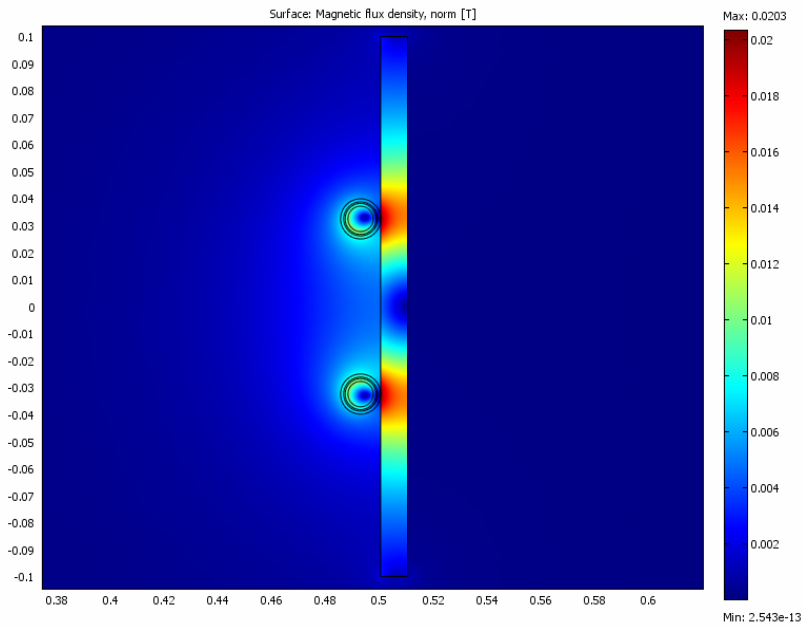

**Figure 6.37 - Magnetic flux density of shielded cables placed with 0.05 m between them and no distance to the magnetic girder.**

A horizontal cross-section plot of the magnetic flux of the cables with a distance of 0.05 m between them is shown in Figure 6.38. The peak of the flux is on the edge of the girder between the two cables, it is 4.60 mT. In the girder the magnetic flux is decreasing linearly and at the opposite side of the girder, from the cables, the flux has decreased to 0.12 mT. From the jacket of the cables the flux is decreased exponentially and at a distance of 4 cm from the jacket the flux has decreased to 1.20 mT.

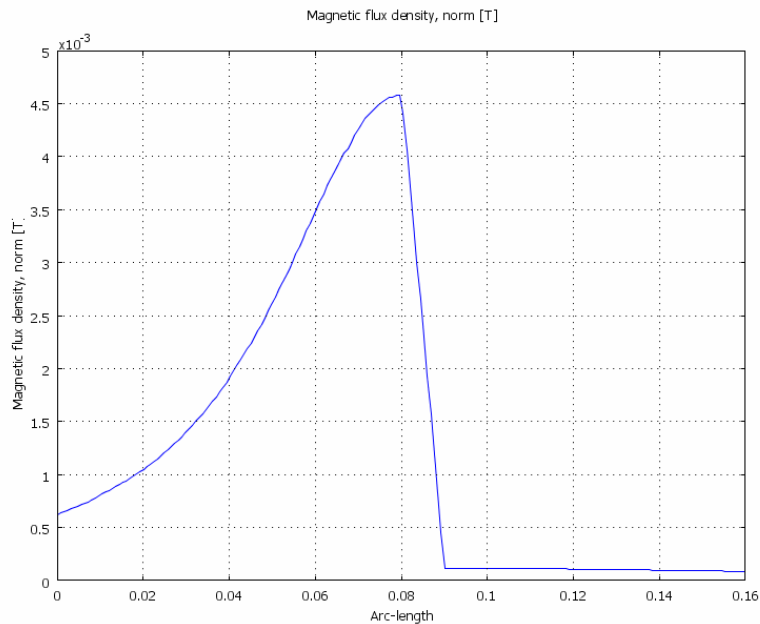

**Figure 6.38 - Horizontal cross-section plot of the magnetic flux density of two shielded cables with a distance of 0.05 m between them and placed next to the magnetic girder.**

A vertical cross-section plot of the magnetic flux density of the cables placed with a distance between them and next to a magnetic girder is shown in Figure 6.39. The two highest peaks of the flux density reach 10.4 mT, and are in the insulation of the cables.

The dip, which is between the two peaks, is in the air between the two cables. The second peaks, which are lower, are in the insulation on the opposite side of the cables. The exponentially decrease is in the air, 4 cm from the jacket of the cables the flux has reached 1.15 mT.

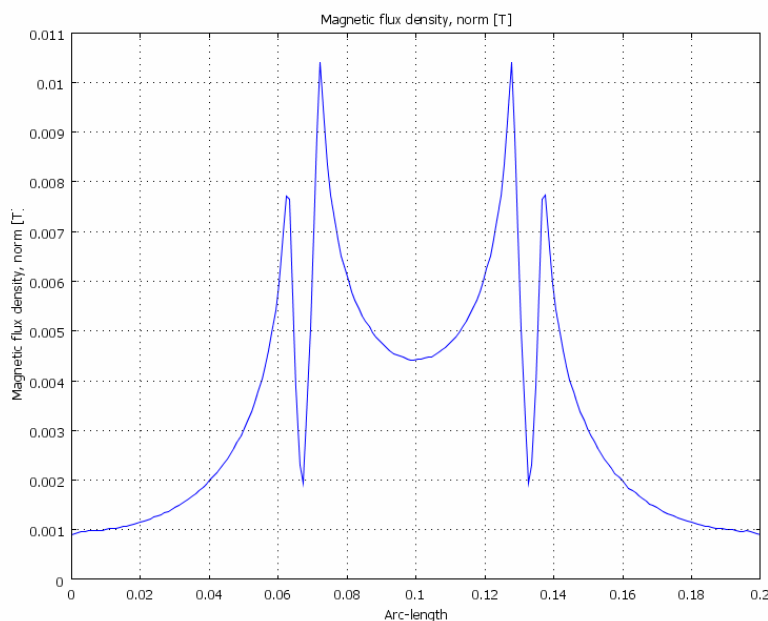

**Figure 6.39 - Vertical cross-section plot of the magnetic flux density of two cables placed with a distance of 0.05 between them and next to a magnetic girder.**

### Discussion of Results

Table 6.5 shows the result of the magnetic flux calculations for the shielded cables. The results for the shielded cables follow the same pattern as the results for the unshielded cables. The flux between the cables is higher for the cables placed close to each other than for the cables with a distance between them. The flux is however decreasing faster with increasing distance from the cables for the cables with no distance between them. When the cables are placed close to a magnetic girder the flux is increased in all cases. For the cables placed next to each other the flux is zero on the opposite side of the girder. For the cables with a distance between them there is a flux on the other side of the girder.

**Table 6.5 - Summarize of the magnetic flux density of the shielded cables.**

<i>Horizontal/ Vertical analysis</i>	<i>Distance between cables [m]</i>	<i>Distance to girder [m]</i>	<i>Peak of flux [mT]</i>	<i>Flux 4 cm from jacket of cable [mT]</i>	<i>Flux opposite side of girder [mT]</i>
H	0	0.5	11.6	0.25	-
V	0	0.5	12.3	0.20	-
H	0.05	0.5	2.50	0.78	-
V	0.05	0.5	9.00	0.50	-
H	0	0	14.0	0.39	0
V	0	0	14.4	0.41	-
H	0.05	0	4.60	1.20	0.12
V	0.05	0	10.4	1.15	-

### 6.4.3 Results of Two Conductor Cables

First the magnetic flux density is examined when the cable with two conductors and a common shield is placed with a distance of 0.5 m to a magnetic girder. Secondly the flux is examined when the cable is placed next to the magnetic girder.

#### Placing with a Distance to the Girder

Figure 6.40 shows a surface plot of the magnetic flux density of the cable with common shield when it is placed 0.5 m from the girder which is conducting magnetic flux. The flux is highest where the insulation of the conductors meets.

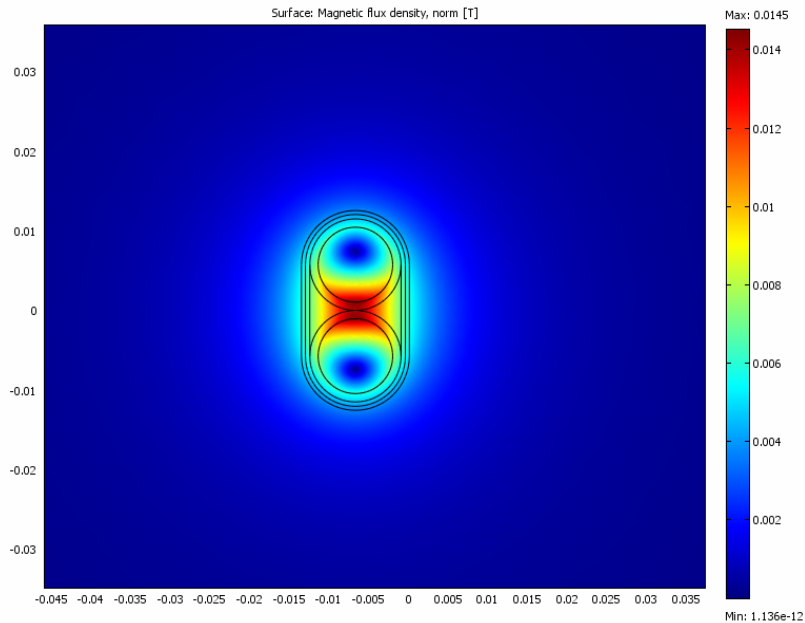

**Figure 6.40 - Magnetic flux density of the cable with common shield placed with a distance of 0.5 m to the magnetic girder.**

The cable with two conductors with a common shield is placed with a distance of 0.5 m to the magnetic girder; a horizontal cross-section plot of the magnetic flux density is seen in Figure 6.41. The peaks and the dip are between the two conductors, the peak reaches 13.5 mT. 4 cm from the cable the flux has decreased to 0.21 mT.

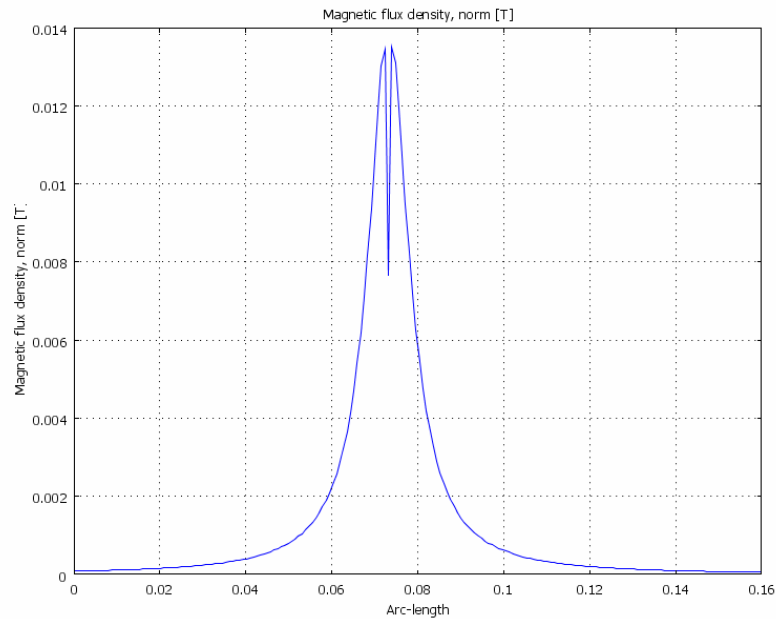

**Figure 6.41 - Horizontal cross-section plot of the magnetic flux density for a cable with two conductors with a common shield and a distance of 0.5 m to the magnetic girder.**

Figure 6.42 shows a vertical cross-section plot of the magnetic flux density of the cable with two conductors with a common shield. The peak of the flux is 14.0 mT, and this peak is located between the insulation of the two conductors. The dips are in the conductor and the second peaks, which are lower, are also in the insulation of the conductors but on the opposite side. The flux is decreasing with increasing distance to the conductors, 4 cm from the jacket of the cable the flux has decreased to 0.17 mT.

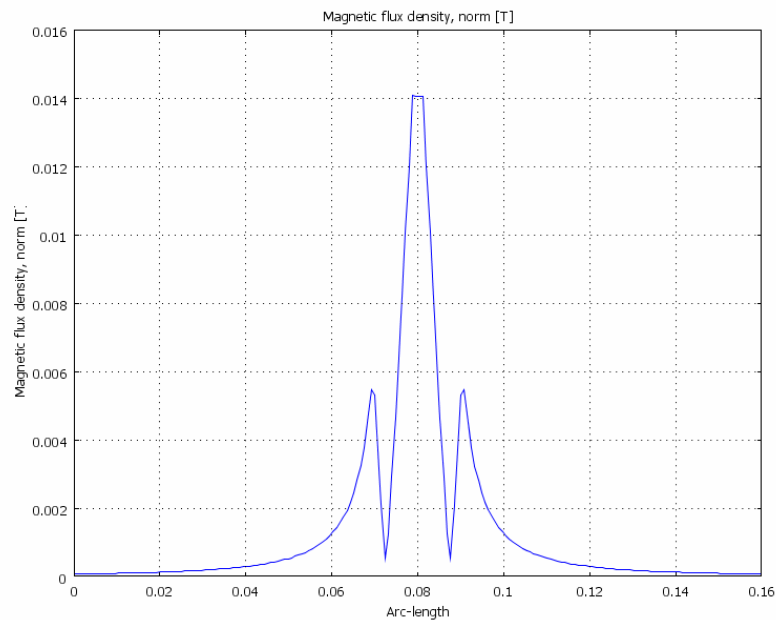
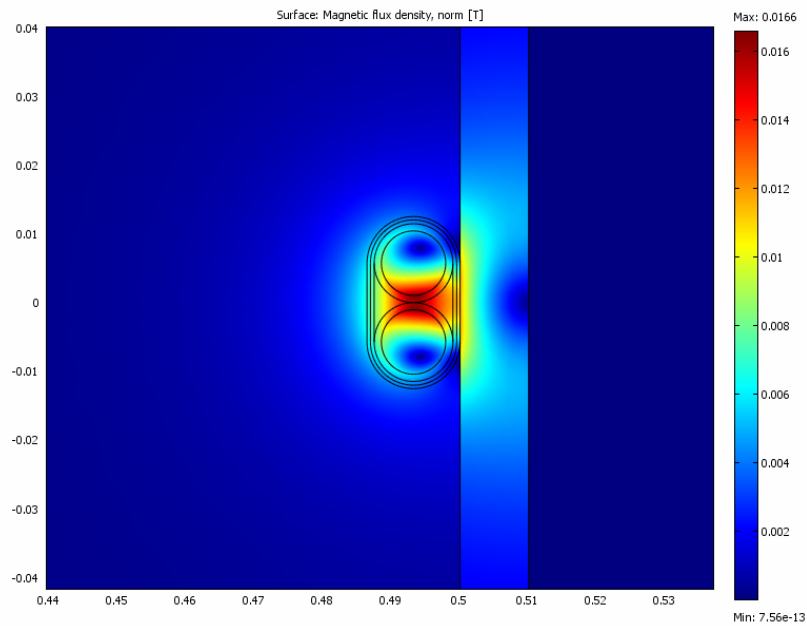

**Figure 6.42 - Vertical cross-section plot of the magnetic flux density for a cable with two conductors with a common shield and a distance of 0.5 m to the magnetic girder.**

### Placing with No Distance to the Girder

The magnetic flux of the cable with two conductors with a common shield is placed with no distance to the magnetic girder is shown in Figure 6.43 as a surface plot. The flux is highest between the cables but is also spread into the magnetic girder.





**Figure 6.43 - Magnetic flux density of the cable with common shield placed with no distance to the magnetic girder.**

A horizontal cross-section plot of the magnetic flux density is shown in Figure 6.44; the cable is placed next to the girder. The peak of the flux is 20.4 mT and is between the cables. The flux has decreased to 0.31 mT at a distance of 4 cm from the cable and on the other side of the girder the flux is zero

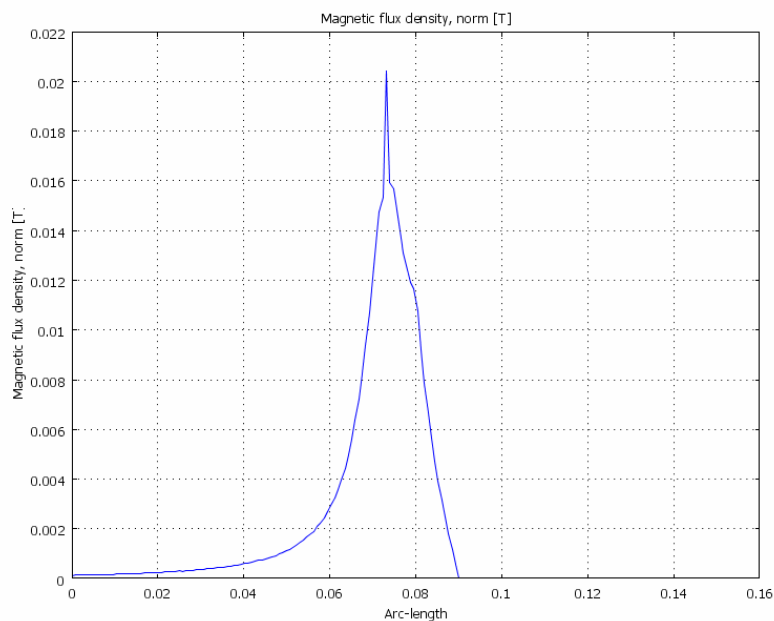

**Figure 6.44 - Horizontal cross-section plot of the magnetic flux density for a cable with two conductors with a common shield and no distance to the magnetic girder.**

The magnetic flux density of a vertical cross-section plot of the cable when it is placed next to the girder is seen in Figure 6.45. The peak of the flux is 16.1 mT. The field is decreasing with increasing distance to the cable and 4 cm from the cable the field has decreased to 0.33 mT.

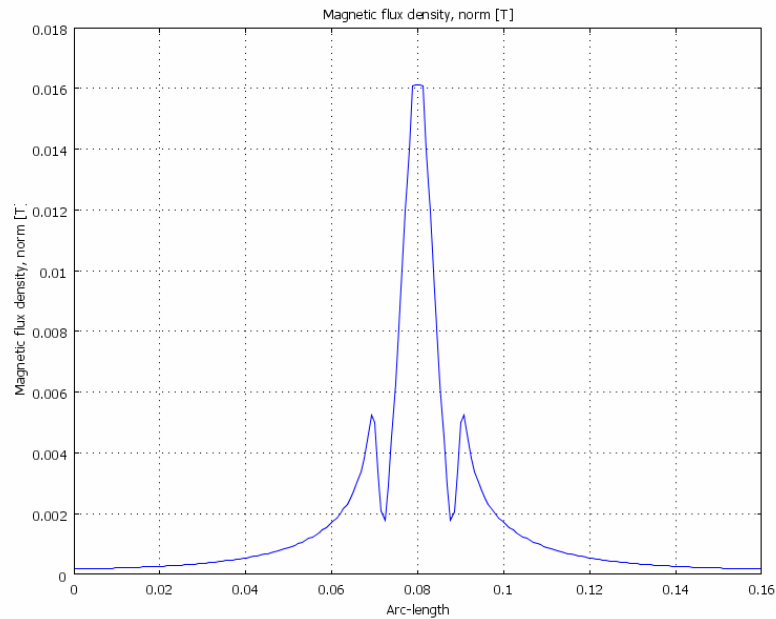

**Figure 6.45 - Vertical cross-section plot of the magnetic flux density for a cable with two conductors with a common shield and no distance to the magnetic girder.**

### Discussion of Results

The result of the calculations of the magnetic flux of the cable with a common shield is shown in Table 6.6. The results of the calculations are that the peak of the flux and the flux at a distance from the cable is higher when the cable is placed close to the girder which is conducting magnetic flux. When the cable is placed next to the girder there is only flux in three directions instead of four, there are no flux on the opposite side of the girder.

**Table 6.6 - Summarize of the magnetic flux density of the cable with two conductors with a common shield.**

<i>Horizontal/ Vertical analysis</i>	<i>Distance between cables [m]</i>	<i>Distance to girder [m]</i>	<i>Peak of flux [mT]</i>	<i>Flux 4 cm from jacket of cable [mT]</i>	<i>Flux opposite side of girder [mT]</i>
H	0	0.5	13.5	0.21	-
V	0	0.5	14.0	0.17	-
H	0	0	20.4	0.31	0
V	0	0	16.1	0.33	-

### 6.5 Conclusions of the Calculations

The conclusions from the magnetic field calculations are that the cable type does not affect the magnetic flux density; it is only affected by the placing of the cables. The shielded cables show a slightly different surface plot than the unshielded cables and the cable with common shield. That is because of the shield and the insulation is increasing the distance between the conductors. The cables with no distance between them shows a higher peak of the flux than the cables with a distance between them, but the flux is decreasing faster for the cables placed with no distance between them. The flux is strengthened between the cables, because the flux of the two cables has the same direction between the cables. Outside the jacket of the cables the fluxes have opposite direction which will weaken the field. It is more important to have low flux in a distance from the cables than between them. Probably there will not be any components placed

on the cables but with a distance to them. Placing the cables close to the girder will increase the flux but will restrict it to three dimensions.

The conclusions from the electric field calculations are that the electric field is decreasing faster when the cables are placed with no distance between them. The peak value of the electric field of the cables placed with no distance between them is not changed with the distance to the grounded girder. The electric field at a distance from the cables is lower when the cables are placed next to the grounded girder than if the cables are placed with a distance to the girder.

---

## 7 Measurements

This chapter will describe the measurements. The simplifications made to the test setup are described, then is the test setups and the measurement methods described. There is a discussion of the results of the measurements of the electric and the magnetic fields. In the last subchapter is a comparison of the measurements and the calculations. Photos from the measurements can be seen in Figure 1 - Figure 8 in Appendix B – Photos from the Measurements.

### 7.1 Simplifications

The test setup is simplified from the real system. In the real system there is an AC/DC-inverter instead of the DC/DC-converter. The DC/DC-converter has been used in thesis works at Volvo Technology before. It is used because of the availability and the ease of controlling. It would be harder to control the inverter which is used in the real system. It is also harder to get hold of one of the inverters used in the real application today since hybrid technology for heavy duty vehicles is rare. The laboratory part of the thesis will be accomplished in a shielded room, where there is limited space. Since the test cell is small an electric motor will not fit in the cell. There will be a battery on the low voltage side of the converter and a resistance on the high voltage side of the converter.

### 7.2 The Test Circuit

The test circuit can be seen in Figure 7.1. The batteries which are used are of type NiMH, they are manufactured by Cobasys. NiMH is rechargeable, the anode is made of a hydrogen-absorbing alloy and the cathode is made of nickel. NiMH batteries are often used in hybrid vehicles, for example Toyota Prius [17]. The load is a resistance, which was borrowed from Chalmers University of Technology. The load has a resistance of  $500\ \Omega$  per phase and has a limit of power of 3 kW. The phase resistances will be connected in parallel to achieve a resistance of  $167\ \Omega$ . The breaker which is connected to the  $100\ \Omega$  resistance is closed first, to avoid rushing the current into the capacitances of the DC/DC-Converter. The test cables, the DC/DC-converter and the control of the DC/DC-converter are described in chapter 3.2 and chapter 5 respectively.

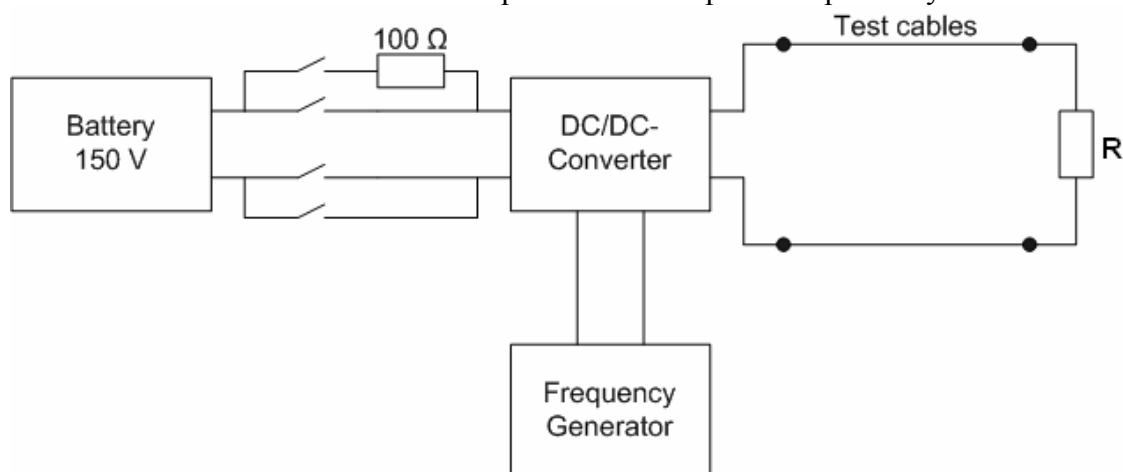

Figure 7.1 - The test circuit.

### 7.3 Measurement Instruments

The instruments used to measure the electric fields are the equipment owned by the test and verification group at Volvo 3P. The electric fields will be measured with a spectrum analyzer; the used spectrum analyzer is made by Rohde & Schwarz. The antennas used

in the measurements are one active monopole antenna which has a measurement range from 30 Hz – 50 MHz and one antenna which has a measurement range from 30 MHz – 3 GHz. The magnetic flux intensity is measured with a Gauss meter with a transverse probe which uses Hall Effect to measure the flux. The Gauss meter is developed by F. W. Bell, Inc. Both the Gauss meter and the probe are borrowed from the division of Applied Physics at Chalmers University of Technology. A list of the measurement instruments can be seen in Table 7.1.

**Table 7.1 - Measurement instruments used in the laboratory experiment.**

<i>Instrument</i>	<i>Manufacturer</i>	<i>ID number</i>
Spectrum analyzer	Rohde & Schwarz	EMC 60456
Gauss meter	F. W. Bell, Inc	07-13-70 24
Amplifier	HP 8447D	EMC 60116
Active Monopole Antenna	EMCO	ANT 60097
Antenna	Schaffner	ANT 60330

## 7.4 Electric Field Measurements

### 7.4.1 Result

The emissions of electric field from the cables in the test setup are measured with the above mentioned measuring equipment. While doing the reference measurement, which is used to find out which emissions come from the cables and which does not, very high electric field emissions was found. Several measures were performed to find the source of the high electric fields. All equipment used to control the DC/DC-converter was moved outside the test cell but the emissions did not lower despite the effort. A test measure was accomplished even though no satisfactory reference measure has been made. Figure 7.2 shows the electric field of the test measure, where the field is minimized as much as possible, and the field should be lower than the red line showing in the plot. There were no changes in the level of the emissions even when the cable type was altered. This implicates that the emissions are produced by the DC/DC-converter, which is not what was intended to study. There were no possibilities to move the DC/DC-converter outside the shielded room since there where no conduit entry in the cell. Since the purpose was to study the electric field emissions of the cables there is a need for a new test setup to be able to compare the cable types.

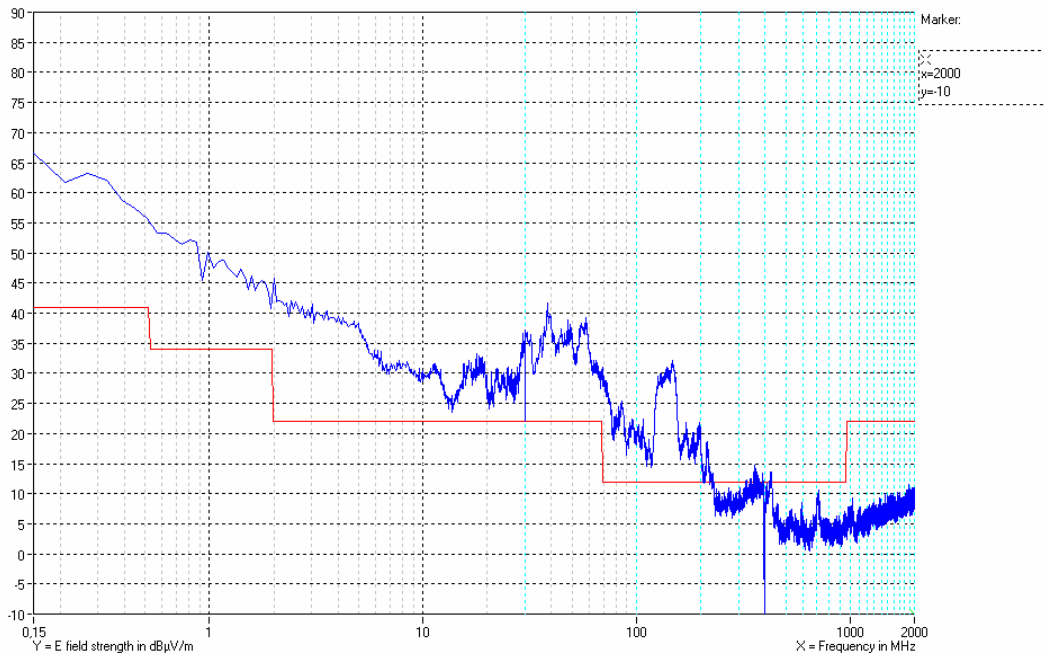

Figure 7.2 - Result of a test measurement, where the field was minimized as much as possible.

### 7.4.2 New Test Setup

The test circuit is changed to be able to see differences between the cable types. Instead of the DC/DC-converter a frequency generator is used. The in signal to the cables is a regular sine-wave with varying power; the power level is adjusted to have a high power signal in all measurements. The power level can be seen in the tables in Appendix A – Results of Electric Field Measurements. The measurements will not give any absolute results of the electric fields but there will be results which will make it possible to compare the cable types to each others. The frequency generator is sending a sine-wave with a frequency which is changed in predetermined steps. The level of the electric field is measured with the spectrum analyzer, at the fundamental frequency. The field is zero at all frequencies except at the fundamental frequency and at the harmonics. The return conductor is connected to the signal ground from the frequency generator which is also the same ground as the grounded plane which the cables are place on. The cables have low resistance and to avoid standing waves on the cables a resistance of 2 Ω is used as load. The new test setup can be seen in Figure 7.3, Table 7.2 holds a list of the equipment used in the new test setup.

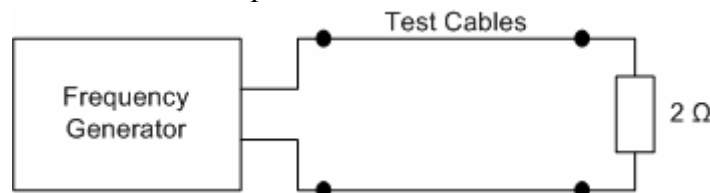

Figure 7.3 - The new test setup.

Table 7.2 - Laboratory equipment in the new test setup.

<i>Instrument</i>	<i>Manufacturer</i>	<i>ID number</i>
Signal Generator	Rohde & Schwarz	EMC 60455
Power Supply	SCR	LAG 60044
Load	Powerload 500	Övr 14
Multimeter	Tektronix	UID 60436
Current Clamp	Prova	TAM 60468

### 7.4.3 Results of Electric Field Measurements

The results of the electric field measurements can be found in Table 1 and Table 2 in Appendix A – Results of Electric Field Measurements. The result is put together in the following graphs, to find the difference between the cable types and the placing of them. The lower-case d gives the distance between the cables and the upper-case d gives the distance to a grounded plane. The disturbances in the real application is in low frequencies, the actual PEC has a switching frequency of 10-15 kHz, therefore the most important result in the graphs is at the low frequencies. The difference between the cables is shown in dBμV in the graphs, (7.1) is used to calculate the difference in volt, [18],

$$U[V] = 10^{\frac{U[dB\mu V]}{20}} \cdot 1\mu V . \tag{7.1}$$

Figure 7.4 shows the electric field of the shielded cables. The blue and the yellow line shows the cables placed 5 cm from the grounded plane with the shield unconnected, the orange and the grey line shows the same cables but when the shield is connected to ground. The graph shows the importance of connecting the shield to ground properly, since the cables with unconnected ground have higher electric field. Depending on which problems should be minimized the ground should be connected in different ways. It is not an easy task to find the right grounding for the shield; it can be connected in both ends or only in one end. In this case the shield is only connected in one end to avoid a loop where a noise current can flow. Comparing the cables with unconnected shield to the unshielded cables one can see that the shielded cables with unconnected shield has a higher electric field than the unshielded cables.

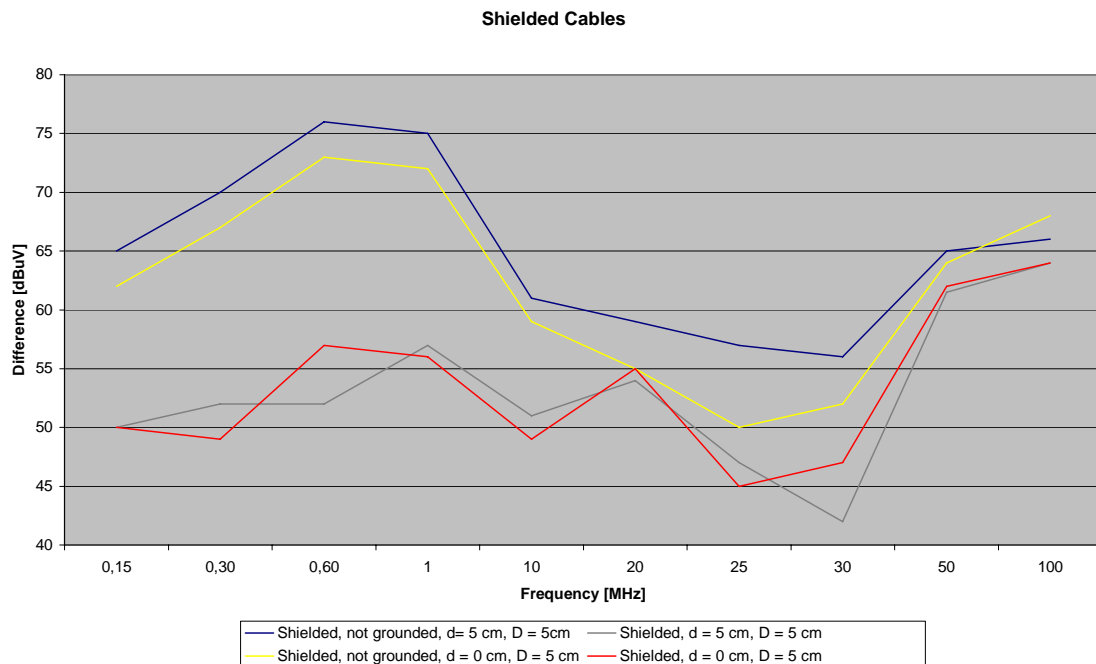

Figure 7.4 - Difference between shielded cables with the shield connected to ground and the shield not connected to ground.

### Results of the Cable Types

Each cable type and placing has its own color of the line in the following plots. E.g. the unshielded cables with no distance between them and no distance to the grounded girder have a green line in all the plots and the cable with common shield which is place 5 cm from the girder has a brown line. Figure 7.5 shows the result of the unshielded cables. Comparing the unshielded cables one can see that the worst result is achieved when the



unshielded cables are placed with a distance between them and a distance to the grounded plane, which was expected. The area between the signal cable and ground is working as an antenna. In the worst case, when the cables are placed 5 cm from each other and 5 cm from the grounded plane, the antenna effect is both between the cables and between the cables and the grounded plane. When the cables have no distance between them and are placed 5 cm from the grounded plane should give a similar result as the cables placed next to the grounded plane and 5 cm between them, the yellow line respectively the black line. The result should be the same since the area between the cable with the signal and the return cable is the same as the area between the signal cable and the grounded plane, resulting in similar antenna effects. The cables with no distance between them and no distance to ground should give the best result since the antenna is reduced, that cable setup also shows the best result in the low frequencies.

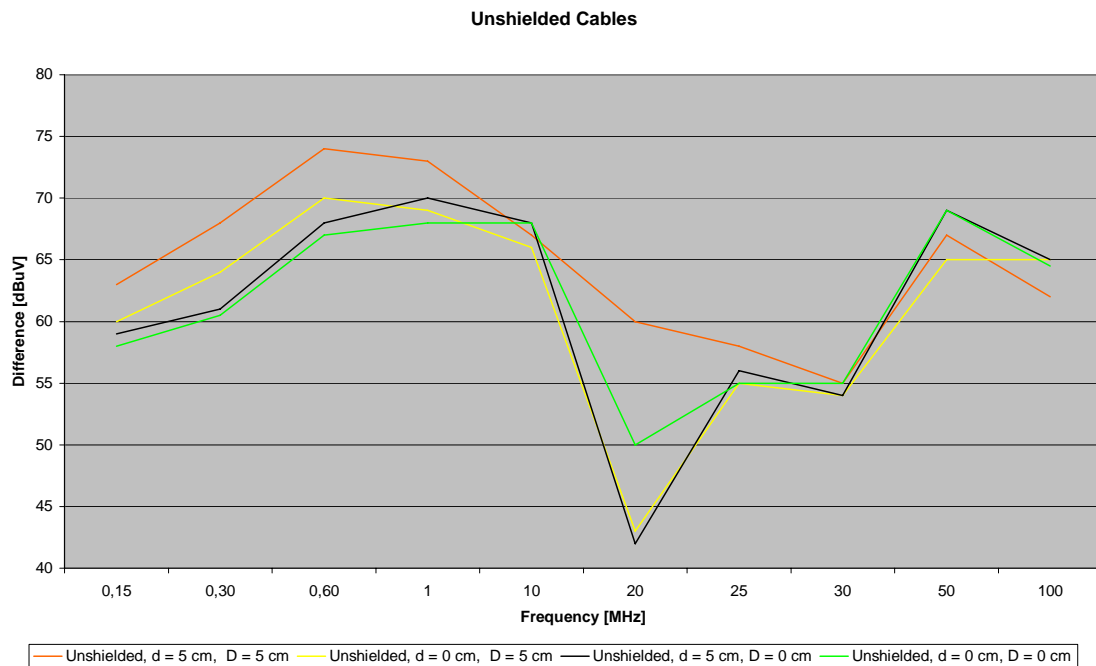

**Figure 7.5 - Results electric field measurements of unshielded cables.**

The result of the shielded cables can be found in Figure 7.6. The result of the shielded cables is hard to interpret since the result is very varying with the frequency. In the lowest frequencies the cables placed next to the grounded plane seems to be the best, which are the pink and the turquoise line. The antenna effect seen in the unshielded cables is much affected by the shield which is connected to ground.

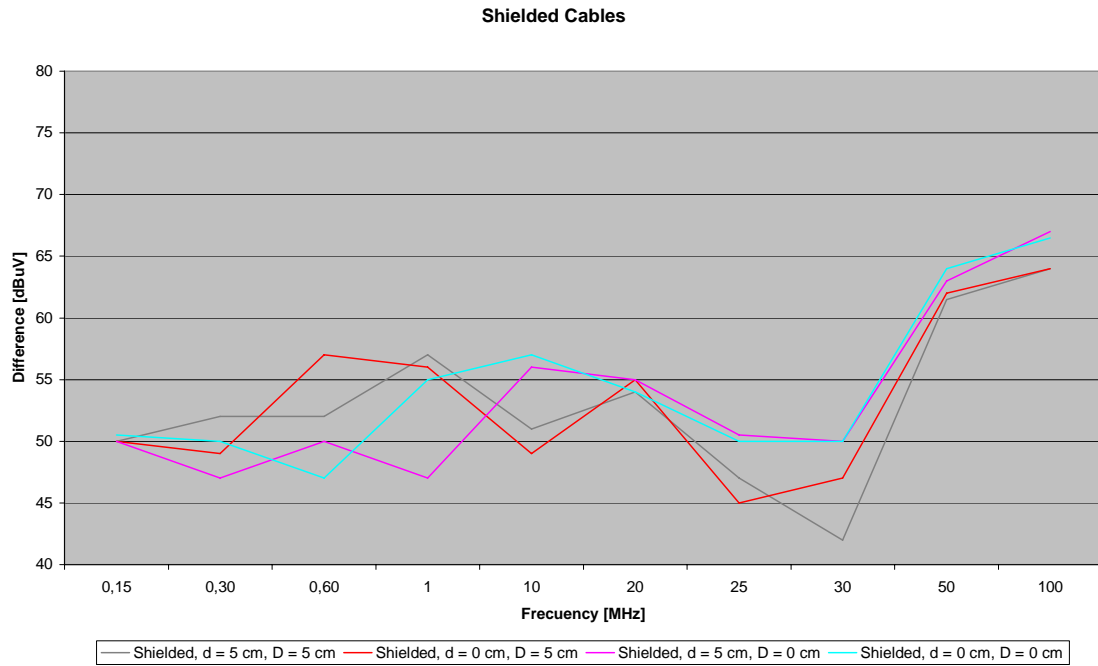

Figure 7.6 - Results of electric field measurements of shielded cables.

Figure 7.7 shows the results of the measurements of the electric field of the cable with a common shield. The result depending on the distance to the grounded plane is almost the same for the cable at all frequencies, the difference is not that big; therefore the placing is not very important for this cable type.

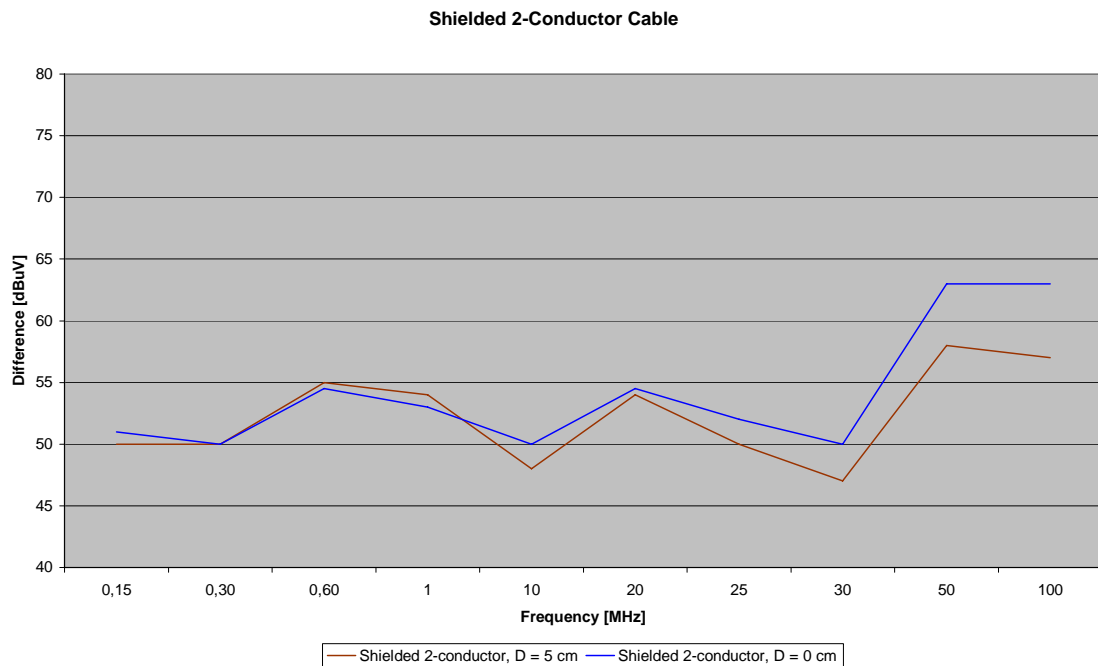
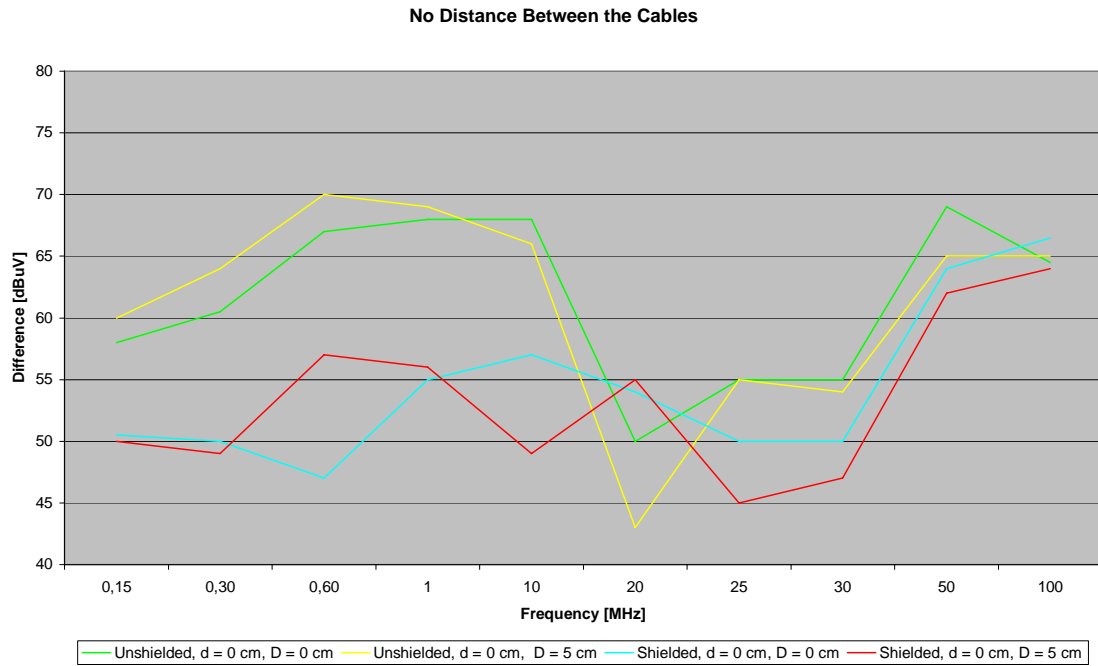

Figure 7.7 - Results of electric field measurements of a cable with a common shield.

### Results when Varying Distance Between the Cables

Figure 7.8 shows the difference in electric field between the unshielded and the shielded cables when they are placed with no distance between them and with different distances to the grounded plane. The unshielded cables have the higher levels of the field than the shielded cables.



**Figure 7.8 - Results of electric field measurements of shielded and unshielded cables placed with no distance between them.**

The electric field of the cables placed with a distance between them is shown in Figure 7.9. Sometimes it may not be possible to place the cables next to each others, and then the cable choice is very important to minimize the antenna effect. Comparing the unshielded and the shielded cables one can see that the shielded cables show a much lower electric field than the unshielded cables. In the lowest frequencies the shielded cable with no distance to the grounded plane shows the best result. Compared to the unshielded cables the antenna effect is reduced with about 10 dB $\mu$ V.

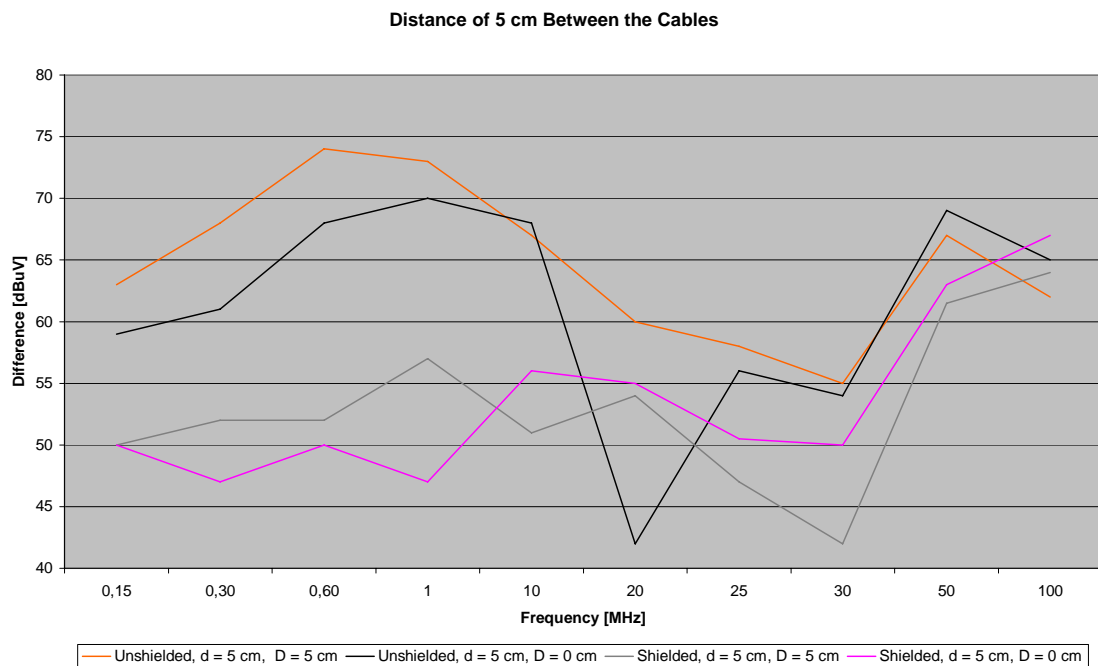

**Figure 7.9 - Results of electric field measurements of unshielded and shielded cables placed with a distance of 5 cm between them.**

### Results when Varying Distance to Girder

Figure 7.10 shows the electric field when the cable types are placed with a distance to the grounded plane. The shielded cable types show the best result, the distance between the cables is not very important, it is more important with shielded cables. Comparison of the shielded cables and the cable with common shield shows almost the same result.

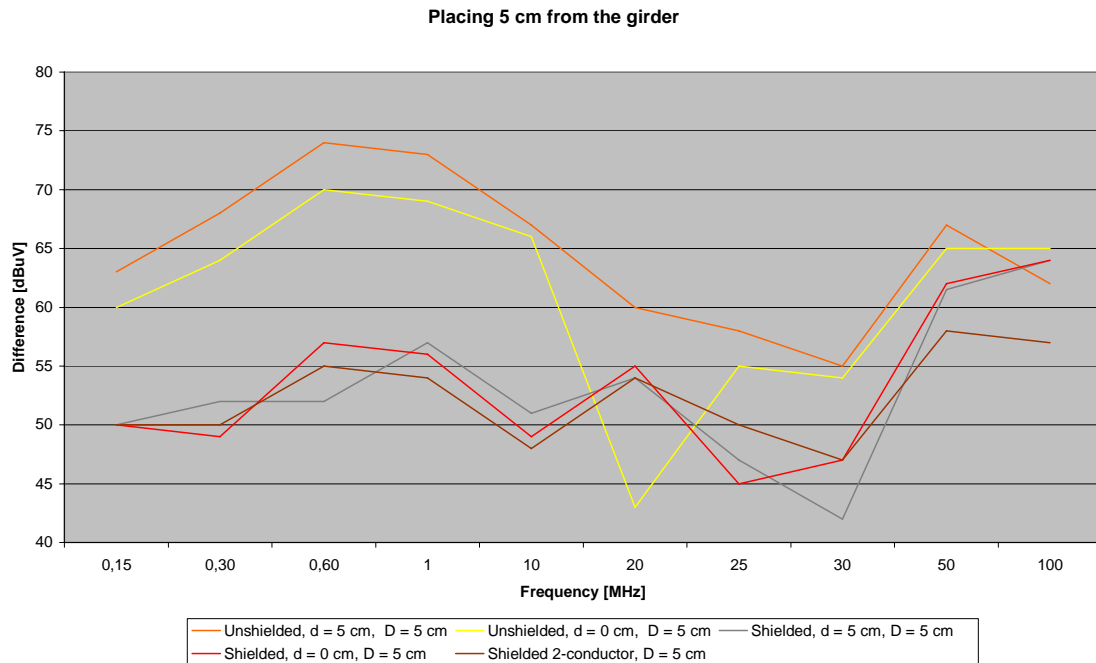

**Figure 7.10 - Results of electric field measurements when the three cable types are placed with a distance of 5 cm from the grounded plane.**

In Figure 7.11 is the electric field of the three different cable types show, when they are placed directly on the grounded plane. Also this plot shows that the importance of choosing a shielded cable instead of an unshihelded cable. The difference in electric field is not very big for the shielded cable and the cable with a common shield. In the lower frequencies the shielded cable with no distance to ground seems to give the best result.

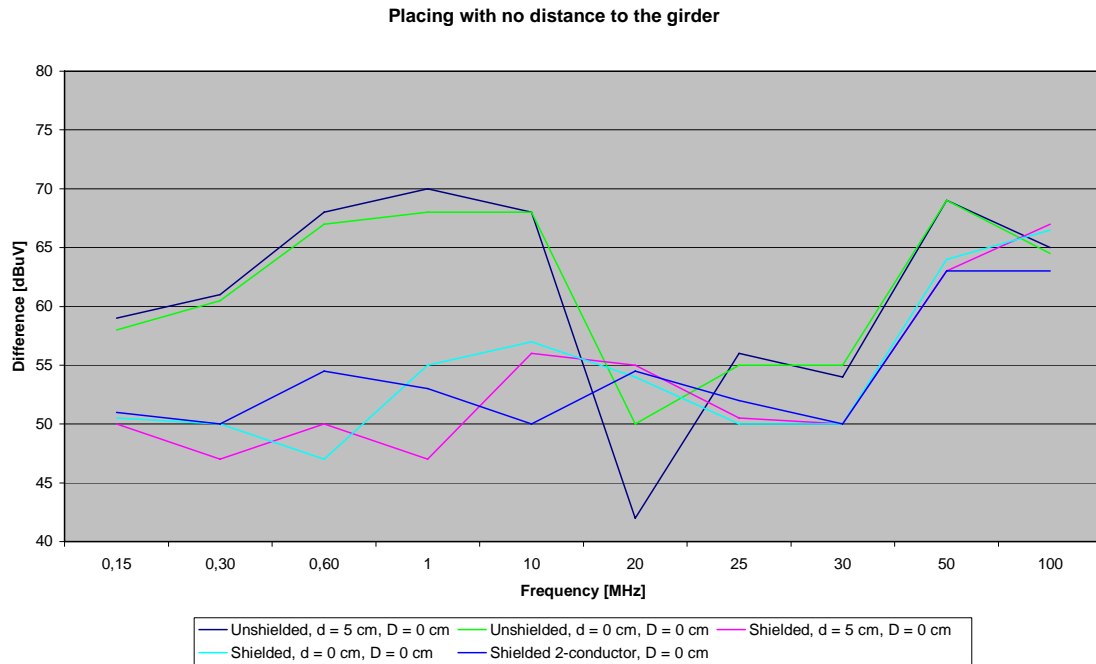

Figure 7.11 - Results of the electric field measurements when the three cable types are placed with no distance to the grounded plane.

## 7.5 Magnetic Field Measurements

### 7.5.1 Test Setup

The resistance which was used in the original test setup has a resistance of  $167 \Omega$  when the phases were connected in parallel, and it has a power tolerance of 3 kW. This was a problem because the resistance was limiting the current when the magnetic field measurements were implemented. Therefore there was a need for a load with low resistance and which could stand high current. One powerload, an electrical instrument with possibilities to adjust the load current, was borrowed from the instrument pool at Volvo. Since the measurement instrument for magnetic field was analog it would be hard to measure fluctuating magnetic fields. To achieve a constant current to measure a constant magnetic field is a DC power supply used instead of the DC/DC-converter. The DC power supply is regulated to supply 10 V and 10 A through the test cables to the powerload. The test setup can be seen in Figure 7.12.

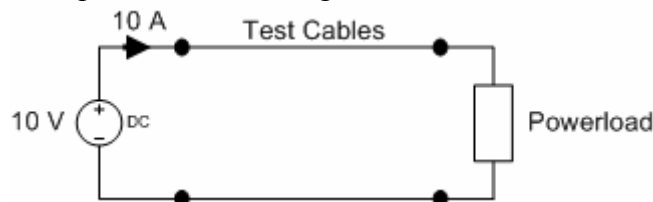

Figure 7.12 - The test setup for magnetic field measurements.

### 7.5.2 Measurement Method

In the first test setup the cables were placed on a 5 cm thick expanded polystyrene foam to create a distance to a table which is covered by a grounded sheet of copper. In the second test setup the cables are placed directly on the grounded copper sheet. At first the cables are placed with a distance of 5 cm between them and the Hall Effect probe is placed 3 cm above the cables. The Gauss meter is adjusted to zero before the measure, to subtract the earth magnetic field. The Gauss meter gives the peak value of

the field. The value of the field is registered by the Gauss meter, then the return conductor is moved towards the carrier conductor and is placed with no distance between them, then the new value is registered. This procedure is used on both the unshielded and the shielded cables; the cable with the common shield is only examined when it is placed directly on the grounded copper plane and when it is placed with a distance to the copper plane.

### 7.5.3 Results

The results from the magnetic field measurements can be seen in Table 7.3. When the unshielded cables are placed with a distance between them there will be a magnetic field around the conductors. The peak value of the field is 28  $\mu\text{T}$ . When the cables are moved together the field is decreased. When the cables are placed with no distance between each other the magnetic fields which are produced around the conductors are canceled, because they have the opposite direction. The magnetic field is not changed when the cables are placed directly on the grounded plane, since copper is not good at conducting magnetic flux. The shielded cables show the same result as the unshielded cables; this is an expected result since the only difference is the shield. The shield does not affect the magnetic field; in this case it only moves the grounded plane closer to the conductor. The shield is made of copper which is a bad magnetic flux conductor; therefore the shield does not affect the magnetic flux. The shield has only effect on minimizing electric fields not magnetic. The two conductors of the cable with common shield is twisted, two measurement points are used on this cable, when the both conductors are placed next to each others in the horizontal plane and when one conductor is placed on top of the other conductor. When the conductor are placed next to each others in the horizontal plane the field is canceled, when they are placed on top of each others the field is 6  $\mu\text{T}$ .

**Table 7.3 - Results of magnetic field measurements.**

<i>Cable type</i>	<i>Distance between cables [m]</i>	<i>Distance to grounded plane [m]</i>	<i>Magnetic flux [Gauss]</i>		<i>Magnetic flux [<math>\mu\text{T}</math>]</i>	
Unshielded	0.05	0.05	0.28		28	
Unshielded	0	0.05	0		0	
Unshielded	0.05	0	0.28		28	
Unshielded	0	0	0		0	
Shielded	0.05	0.05	0.28		28	
Shielded	0	0.05	0		0	
Shielded	0.05	0	0.28		28	
Shielded	0	0	0		0	
Two Conductor	-	0.05	0	0.06	0	6
Two Conductor	-	0	0	0.06	0	6

### 7.6 Discussion of the Measurements

The result of the unshielded cables shows that the lowest electric fields are achieved when the cables are placed with no distance between each others and next to the grounded plane. The shielded cables showed a result which was difficult to interpret, but the best result ought to be when the cables are placed on the grounded plane. The cable with two conductors with a common shield shows almost no difference in the lower frequencies, depending on the distance to the grounded plane. Looking at the plot of the results when the cables are placed with no distance between them and at the plot of the cables with a distance between them a big difference between the cable types can

be seen. The shielded cables give lower electric field than the unshielded cables both when there is no distance between the cables and when there is a distance of 5 cm between them. In the plots where the cables are placed with no distance to the girder and at a distance of 5 cm to the girder it is also seen that the unshielded cables gives much higher field than the shielded cable types. Figure 7.13 shows the result of the three cable types which showed the best results. The unshielded cables have a higher difference in electric field than the shielded cable types, but the results of the shielded cable types does not differ much in difference of electric field.

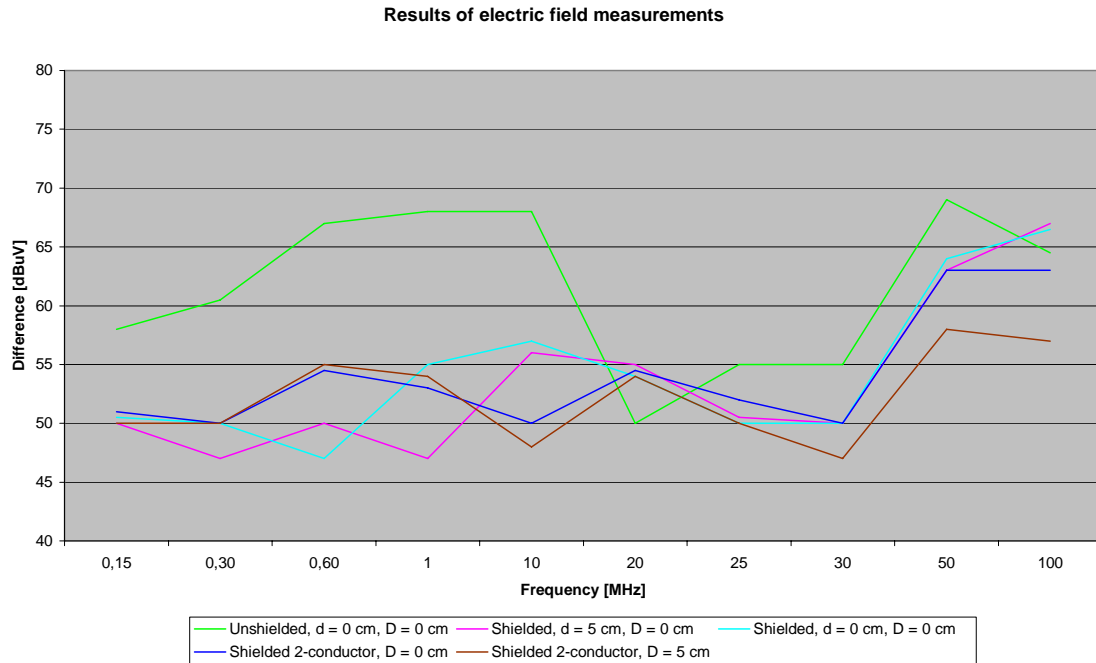

**Figure 7.13 - Electric field of the cables with the best results.**

The magnetic field is not affected by the grounded plane which was made of copper, copper conducts magnetic flux bad. The magnetic flux is neither affected by the shield, since the shield is made of copper which has the same permeability as air and REMS. The magnetic flux is only affected by the placing of the cables considering the distance between the carrier and the return. When the cables are placed with no distance between them the magnetic flux is extinguished. The flux density is increasing with increasing distance between the carrier and the return. To minimize the magnetic flux the cables should be placed with no distance between them.

## 7.7 Comparison with Calculations

The results of the measurements and calculations of the electric field are hard to compare, since the measurement and the calculations differ much in setup and measurement points. The values from the calculations of the electric field, which are used are in the comparison with the measured values, are the electric field at a distance from the cables. The result from the measurements, that the unshielded cable gives the lowest fields when it is placed with no distance between them and no distance to the grounded girder is also seen in the calculations. When the cables are placed on the grounded plane with a distance of 5 cm between them shows the same result as the cables placed with no distance between them and 5 cm to the grounded plane both in the calculations and the measurements. The cables placed with 5 cm between them and 5 cm to the grounded plane shows the worst result of the unshielded cables. The result of the calculations corresponds to the result of the measurements.

The results from the calculations of the magnetic field are showing the same result as the measurements. The magnetic field is not changed when the cable type is changed. When the cables are placed with no distance between them the magnetic field is lowered in both the calculations and the measurements. Since the material which the cables were placed on in the measurements was not magnetic, there can not be a comparison of how the magnetic girder changes the flux.



## 8 Conclusion

The test setup with the DC/DC-Converter, which was used in the first setup of the electric field measurements, showed very high emissions, see Chapter 7.4.1. The results from the measurements with the DC/DC-Converter showed that the casing of the electric equipment is more important than the cable type and the placing of the cables. Suppression must be accomplished at the source of the disturbances; the cables will only help to spread the disturbances.

The electric field is minimized by the cable type, the shielded cable types shows the lowest emissions. At 0.15 MHz there is a difference of 8 dB $\mu$ V between the unshielded and the shielded cables, and at 0.60 MHz is the difference increased to 18 dB $\mu$ V. The unshielded cables have a difference of 5 dB $\mu$ V or more at almost all frequencies. There where very little difference between the shielded cables and the cable with common shield, the shielded cables show lower emissions than the cable with common shield at the lowest frequencies. At 0.15 MHz is there almost no difference in the emissions of the electric fields. The difference between the shielded cables and the cable with common shield is increased, and at 0.30 MHz the difference is 3 dB $\mu$ V. At 0.60 MHz the difference has increased to 5 dB $\mu$ V. At the higher frequencies there is almost no difference between the shielded cables and the cable with common shield. Since the PEC has a low switching frequency, 10-15 kHz, the most of the disturbances will be at the lower frequencies. The separately shielded cables are easier to handle than the cable with common shield, which is an important aspect for installations built in a serial production. The cable with common shield was hard to bend and place as intended, the shielded cables were easier to place and bend the right way. The electric field is decreasing faster if the cables are placed with no distance between them and the magnetic field is extinguished if the cables are placed with no distance between them. At 10 A is the magnetic field 28  $\mu$ T when the cables are placed with 5 cm between them. The distance between the cables should be minimized to lower the electromagnetic fields. The magnetic field is increased when the cables are placed with no distance to the girder which is conducting magnetic flux, but the electric field is minimized when the cables are placed with no distance to the grounded girder. The electric field is lowered with 5 dB $\mu$ V when the shielded cables are placed with no distance to the grounded girder. The electromagnetic field is only spread in three directions when the cables are placed next to the girder. The best placing of the cables is depending of which field to minimize. The emissions of the electric field are minimized by placing the cables with no distance between them and with no distance to the grounded girder. Minimizing the magnetic field is done by placing the cables with no distance between them and with a distance to the girder which is conducting magnetic flux.

Recommendation: Separately shielded cables placed next to the girder with no or as little distance between them as possible. If the cables are placed next to the girder with a distance between them extra care is need to be taken since the girder will help the flux to spread and that can stress adjacent components.

---

## 9 Future Work

It is hard to simulate a system. It is almost impossible to simulate the loads in a HHDV, since the power consumption of the loads is changing. It is impossible to adapt all the loads in a HHDV to avoid standing waves. Even if the system is good for one simulation it might not give the right results in the next simulation if one load is changed. One future step in EMC analysis is to measure the electromagnetic fields in the real application, a functional HHDV, but then the focus will not probably be on the cables. To focus more on the cables a setup which is will give the same emissions like the actual setup can be examined. Having a setup which will give a rippling DC voltage of 600 V and a fluctuation current of 200 A would be an interesting case to examine. Then it would be interesting to examine how different grounding methods and how different clamping methods affects the electromagnetic field emissions Since the calculations gave results which was corresponding well to the measurements, it would be interesting to calculate a more advanced case than the one calculated in this thesis. The shield of the cables could be made more like a braid to get good results of the calculations of the electric fields. Instead of a static case data from a drive cycle can be used. It could be useful to compose a guideline of cable routing on system level. The guideline can improve the routing of the cables to avoid EMI problems which might be found at validations. This would lower the expenses by avoiding rerouting of the cables at a later stage in the project.

---

## 10 References

- [1] Cheng, David K. (1993). *Fundamentals of Engineering Electromagnetics*. Reading, Mass.: Addison-Wesley.
- [2] *Electric Displacement* (2007). (Electronic) Encyclopædia Britannica. Accessible: Encyclopædia Britannica Online. (2007-01-30)
- [3] Beams, Jesse W. (2000). *Electromagnetic field*. (Electronic) AccessScience. Accessible: AccessScience. (2007-01-30)
- [4] White, Donald R. J. (2002). *Electric Interference*. (Electronic) AccessScience. Accessible: AccessScience. (2007-01-30)
- [5] Keiser, Bernhard E. (2002). *Electromagnetic Compatibility*. (Electronic) AccessScience. Accessible: AccessScience. (2007-01-30)
- [6] White, Donald R. J. (2000) *Suppression (Electricity)*. (Electronic) AccessScience. Accessible: AccessScience. (2007-01-30)
- [7] Aykan, Aydin (1999). *Magnetic Field Measurement*. (Electronic) Wiley Encyclopedia of Electrical and Electronics Engineering. Accessible: Wiley Encyclopedia of Electrical and Electronics Engineering. (2007-02-01)
- [8] Kanda, Motohisa (1999). *Electromagnetic Field Measurement*. (Electronic) Wiley Encyclopedia of Electrical and Electronics Engineering. Accessible: Wiley Encyclopedia of Electrical and Electronics Engineering. (2007-02-01)
- [9] Volvo Group (2006). *Electro-Magnetic Compatibility, EMC*. Version 2. (Unpublished)
- [10] The Commission Directive 2004/104/EC
- [11] Waldron, Robert D. & Bailey, Earle A. (2000). *Electric Susceptibility*. (Electronic) AccessScience. Accessible: AccessScience. (2007-02-05)
- [12] *Magnetic Susceptibility* (2007). (Electronic) Encyclopædia Britannica. Accessible: Encyclopædia Britannica Online. (2007-02-05)
- [13] ATIS Committee T1A1 (2001). *Definition Electromagnetic Susceptibility*. (Electronic) Accessible: [http://www.atis.org/tg2k/\\_electromagnetic\\_susceptibility.html](http://www.atis.org/tg2k/_electromagnetic_susceptibility.html)
- [14] Huber + Suhner AG. *Group Site*. (Electronic) Accessible: <http://www.hubersuhner.com>. (2007-02-12)
- [15] Mohan, Ned, Undeland, Tore M. & Robbins, William P. (2003). *Power Electronics: Converters, Applications and Design*. Hoboken, N.J.: John Wiley & Sons, Inc.
- [16] Ott, Henry W. (1988). *Noise Reduction Techniques in Electronic Systems*. New York: John Wiley & Sons, Inc.
- [17] *Nickel Metal Hydride Battery*. Wikipedia, The Free Encyclopedia. (Electronic) Accessible: [http://en.wikipedia.org/wiki/Nickel\\_metal\\_hydride\\_battery](http://en.wikipedia.org/wiki/Nickel_metal_hydride_battery). (2007-05-04)
- [18] Circuit Design, Inc. (Electronic) Accessible: [http://www.cdt21.com/products/tech\\_info/guide5.asp](http://www.cdt21.com/products/tech_info/guide5.asp) (2007-06-25)

---

## Appendix A – Results of Electric Field Measurements

**Table 1 – Results of electric field measurements of cables placed with a distance of 5 cm to a grounded plane.**

Power (dBm)	Frequency (MHz)	Unshielded, d = 5 cm, D = 5 cm	Unshielded, d = 0 cm, D = 5 cm	Shielded, d = 5 cm, D = 5 cm	Shielded, d = 0 cm, D = 5 cm	Shielded 2-conductor, D = 5 cm
-15	0.15	63	60	50	50	50
-15	0.30	68	64	52	49	50
-15	0.60	74	70	52	57	55
-20	1	73	69	57	56	54
-35	10	67	66	51	49	48
-65	20	60	43	54	55	54
-65	25	58	55	47	45	50
-65	30	55	54	42	47	47
-30	50	67	65	61.5	62	58
-30	100	62	65	64	64	57

**Table 2 – Results of electric field measurements of cables placed with no distance to a grounded plane.**

Power (dBm)	Frequency (MHz)	Unshielded, d = 5 cm, D = 0 cm	Unshielded, d = 0 cm, D = 0 cm	Shielded, d = 5 cm, D = 0 cm	Shielded, d = 0 cm, D = 0 cm	Shielded 2-conductor, D = 0 cm
-15	0.15	59	58	50	50.5	51
-15	0.30	61	60,5	47	50	50
-15	0.60	68	67	50	47	54.5
-20	1	70	68	47	55	53
-35	10	68	68	56	57	50
-65	20	42	50	55	54	54.5
-65	25	56	55	50.5	50	52
-65	30	54	55	50	50	50
-30	50	69	69	63	64	63
-30	100	65	64.5	67	66.5	63

---



## Appendix B – Photos from the Measurements

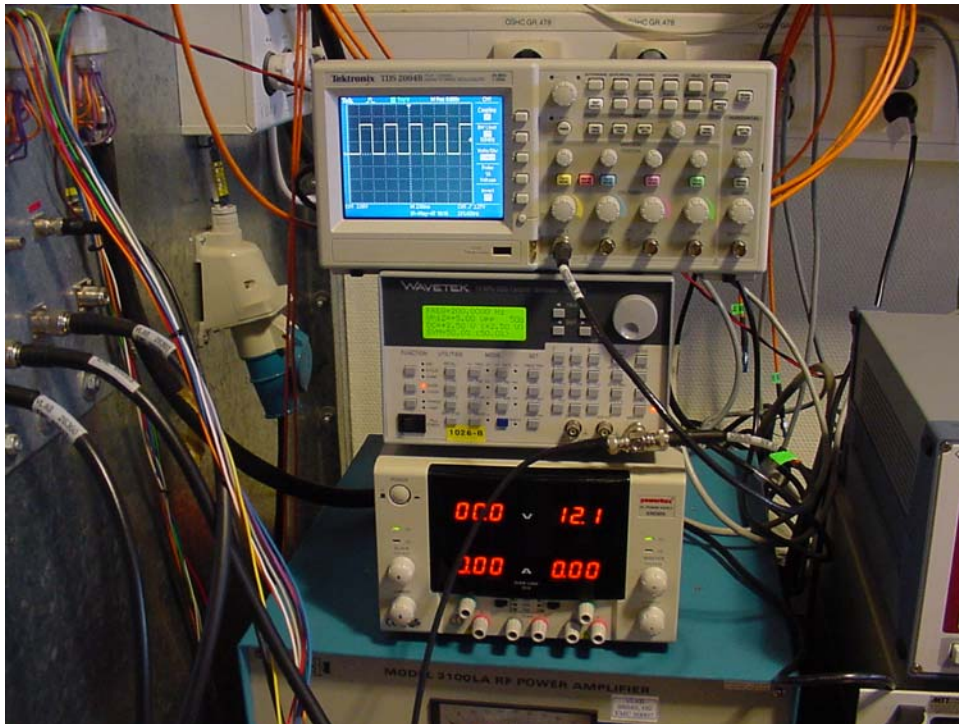

Figure 1 - Equipment used to control the DC/DC-Converter.



Figure 2 - The antenna, the DC/DC-Converter, the breakers and the test cables in the electric field measurements.



**Figure 3 - The shielded cables placed with no distance between them 5 cm from the grounded plane.**

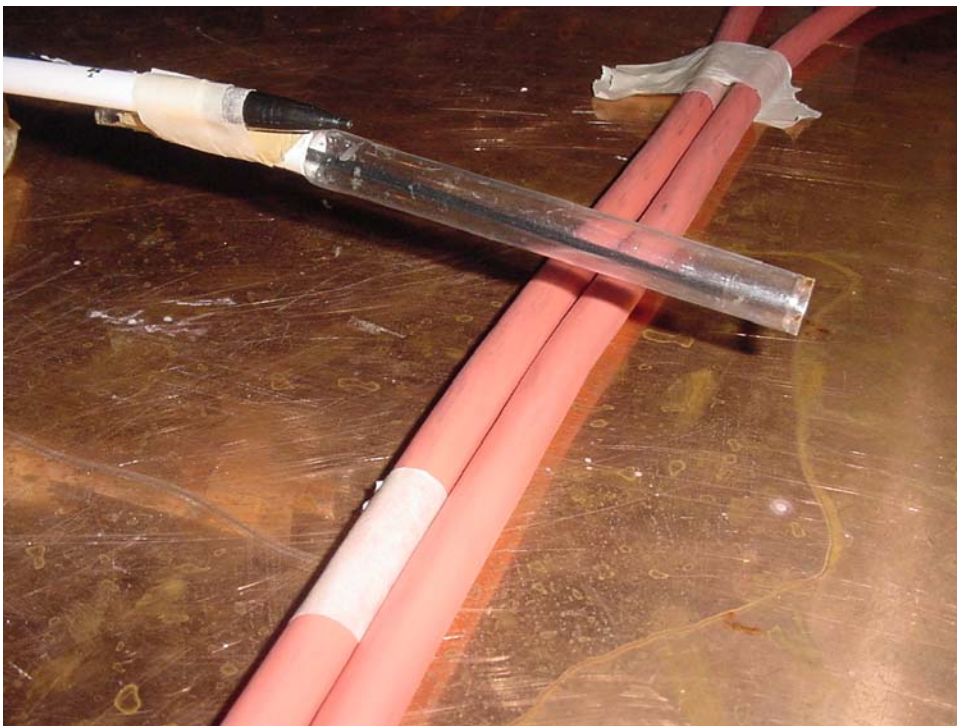
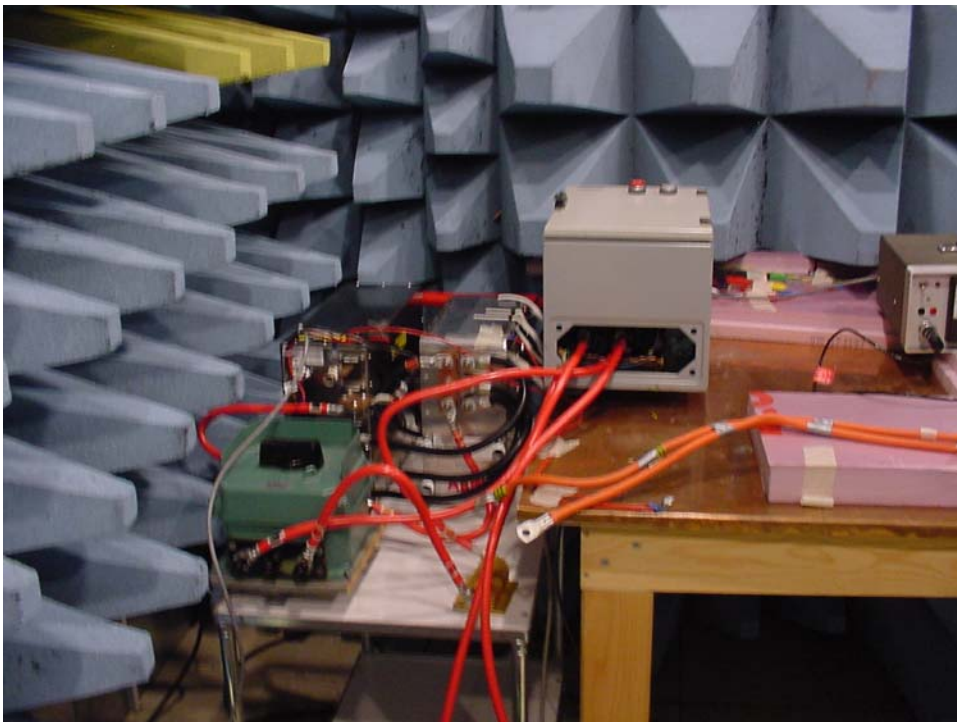

**Figure 4 - Measurement of magnetic field with Hall Effect sensor of unshielded cables placed with no distance between them and placed on the grounded plane.**





**Figure 5 - Measurement of magnetic field with Hall Effect sensor of unshielded cables placed with a distance of 5 cm between them and placed on the grounded plane.**



**Figure 6 - The DC/DC-Converter and the breakers.**

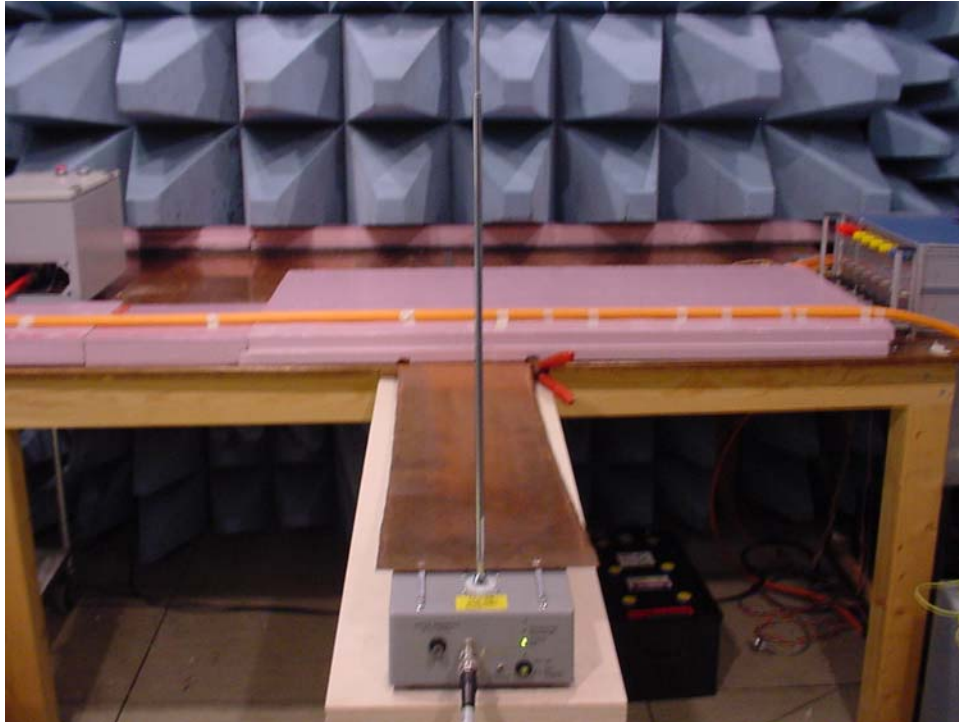

Figure 7 - The active monopole antenna which was used during the electric field measurements.



Figure 8 - The display of the Gauss meter which was used during the magnetic field measurements.