

CHALMERS

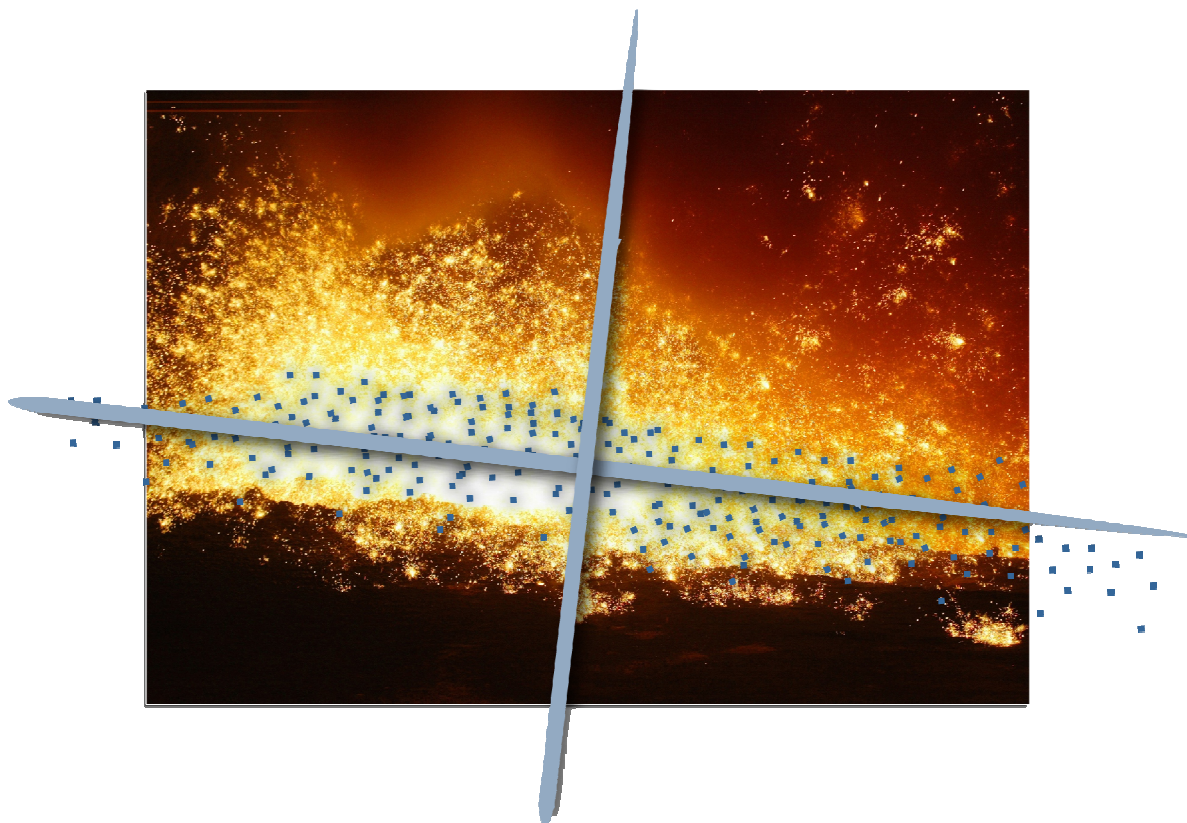

Identifying, visualizing and quantifying process disturbances at SSAB Oxelösund using multivariate modelling

Diploma Thesis in the Biotechnology Engineering Programme

HENRIK RÅDBERG

Department of Chemical Reaction Engineering
Division of Chemistry and Biotechnology
CHALMERS UNIVERSITY OF TECHNOLOGY
Göteborg, Sweden, 2007



This report is a part of a research project supervised by
IVL Swedish Environmental Research Institute Ltd.

**Identifying, visualizing and quantifying process disturbances at SSAB Oxelösund
using multivariate modelling**

© Henrik Rådberg, 2007

Department of Chemical Reaction Engineering
Chalmers University of Technology
SE-412 96 Göteborg, Sweden

Department of Chemical Reaction Engineering
Göteborg, 2007

*Cover: Crude iron discharge from blast furnace, SSAB Tunnsplåt AB, Luleå
Photo: Stig-Göran Nilsson (2002)
The illustration shows principal components describing variation in a data set*

Abstract

Identifying, visualizing and quantifying process disturbances at SSAB Oxelösund using multivariate modelling

Henrik Rådberg
Department of Chemical Reaction Engineering
Chalmers University of Technology

Modern process lines give rise to huge amounts of data which are stored in databases. Multivariate analysis comprises useful tools to grasp useful information from the datasets. In the present study principal component analysis (PCA), projection to latent structures (PLS) and hierarchical PCA has been used to create models of five process steps at a Swedish steelworks. The focus has been to identify and explain relations to quality problems in each step, both within the step itself, but also from upstream processes using hierarchical PCA.

The five process steps that have been modelled are the blast furnace, desulphurization in the torpedo car, basic oxygen steelmaking in the LD–LBE-converter, secondary steelmaking in ladle and ladle furnace and, finally, continuous casting of slabs. Among the results achieved it is found that:

- PLS prediction of crude iron analysis from blast furnace discharge has been made with a fraction of explained variance for external validation (Q_{PS}^2) above 20% for P, Cr, Cu, Ti, CaO, SiO₂, MgO and basicity. The data resolution was relatively low.
- Hierarchical modelling revealed correlations between the process steps, e.g. that LD-converter treatments registered as severe slopping heats have a titanium content in the incoming crude iron that is higher than average.
- Heats with too high phosphorous content after LD-treatment can be identified as having low silicon content in the crude iron, which makes it impossible to create the necessary slag amount for desired phosphorous cleaning effect.
- High sulphur content in the torpedo car demands a long treatment time. If the silicon content is low in such a batch, there is an evident risk that it will not have high enough temperature in the secondary steelmaking.
- Capturing reasons for quality problems during casting is difficult due to the low variation in data. The main variations exist between the steel qualities. However, the importance of casting properties such as oscillations for visual quality of the slabs, and temperature and steel analysis for slab inner quality have been recognized.

Keywords: Multivariate analysis; PCA; PLS; hierarchical modelling; process modelling; blast furnace; steelworks

Sammanfattning

Moderna processindustrier ger upphov till stora mängder data som sparas i databaser. För att analysera dessa datauppsättningar och få ut användbar information används ofta statistiska verktyg i form av multivariata metoder såsom principalkomponent analys (PCA) och projektion till latent strukturer (PLS). PCA används för klassificering och för att skaffa sig en överblick över de observationer (objekt) som finns i datauppsättningen medan PLS används för prediktion av en eller flera intressanta responser (Y-variabler). I detta arbete PCA och PLS använts för att modellera fem processteg på SSAB Oxelösunds stålverk. Fokus har legat på att identifiera och förklara samband mellan kvalitetsproblem i varje processteg. Sambanden har sökts såväl inom processteget som i tidigare processer genom användning av hierarkisk modellering.

De fem processteg som undersökts är masugn, avsvavling i torpeder, färskning i LD-LBE-konverter, skänkmetsallurgi och stränggjutning. Bland erhållna resultat märks följande:

- PLS-prediktion av råjärnsanalyser från masugnstappningar har gett förklaringsgrader på över 20% vid extern validering (Q_{PS}^2) för följande ämnen: P, Cr, Cu, Ti, CaO, SiO₂, MgO samt basicitet.
- Hierarkisk modellering har påvisat samband mellan processteg, exempelvis att LD-charger med stora utkok haft högre titanhalt i råjärnet än medelvärdet av alla observationer.
- Charger med för hög fosforhalt efter färskning uppvisar samband med låg kiselhalt i det inkommande råjärnet. Den låga kiselhalten förhindrar att tillräckligt mycket slagg kan bildas vilket hämmar fosfosreningen.
- Hög svavelhalt i råjärnet kräver långa behandlingstider i avsvavlingssteget. Om dessutom kiselhalten är låg är det stor risk att chargen hamnar lägre i temperatur än gränsvärdet vid skänkbehandlingen tillåter.
- Modellering av kvalitetsproblem vid stränggjutningen har försvårats av låg variation i datauppsättningen eftersom de främsta variationerna återfinns mellan olika stålqualiteter. Samband mellan kokillens oscillering och stålämnets ytkvalitet har dock kunnat fastställas, liksom inverkan av temperatur och stålsammansättning i gjutlådan på stålämnets inre kvalitet.

Contents

Abstract	3
Sammanfattning	4
Contents	5
1. Objectives and scope	7
1.1. Objectives	7
1.2. Scope	7
2. Theoretical background	8
2.1. Multivariate statistical methods	8
2.1.1. Principal component analysis (PCA)	9
2.1.2. Projection to latent structures (PLS)	13
2.1.3. Hierarchical modelling	16
2.2. Steelmaking	16
2.2.1. Overview of the process	17
2.2.2. Thermodynamics and kinetics	18
2.2.3. Crude iron production: Blast furnace	19
2.2.4. Desulphurization: Torpedo car	21
2.2.5. Basic oxygen steelmaking: LD–LBE-converter	21
2.2.6. Secondary steelmaking: TN-station and ladle furnace	22
2.2.7. Continuous casting	23
2.2.8. Challenges in the production line	24
2.3. Previous studies of steelworks using multivariate methods	25
3. Data treatment and modelling	27
3.1. Data pretreatment	27
3.1.1. Data extraction and structure	27
3.1.2. Variable selection	28
3.1.3. Block construction	29
3.2. Modelling	29
3.2.1. Block modelling	29
3.2.2. Hierarchical modelling	31
4. Results	32
4.1. Block modelling	32
4.1.1. Blast furnace (BF)	32

4.1.2.	Desulphurization (TP)	34
4.1.3.	Basic oxygen furnace (LD)	35
4.1.4.	Secondary steelmaking (SS)	36
4.1.5.	Continuous casting (CC)	37
4.2.	Hierarchical modelling	39
4.2.1.	Slopping	40
4.2.2.	Analysis misses	40
4.2.3.	Temperature misses	40
4.2.4.	Slab quality	41
5.	Discussion and conclusions	42
5.1.	Blast furnace modelling	42
5.2.	Desulphurization and LD-treatment	42
5.3.	Secondary steelmaking	43
5.4.	Continuous casting	43
6.	Proposals	45
	Acknowledgements	46
	References	47
	Appendix A: Engelsk–svensk ordlista	49
	Appendix B: Variable list	50
	Primary observation identification	50
	Observation labels	50
	Variables in the blast furnace block	51
	Variables in the desulphurization block	52
	Variables in the basic oxygen furnace block	53
	Variables in the secondary steelmaking block	54
	Variables in the continuous casting block	56

1. Objectives and scope

The amount of process data collected at modern process facility makes it possible to use multivariate techniques to gather useful information about the process in a variety of ways, for example:

- Classify a process state as belonging to normal operation or not.
- Reveal underlying explanations to known disturbances.
- Detect unknown disturbances and suggest causalities.
- Predict important quantities or qualities.

It is however important to have an idea of what phenomena that may be present and possible to study before starting to collect and treat data. This study is performed as a part of a research project supervised by IVL Swedish Environmental Research Institute, and the objectives and scope are described in subsequent sections.

1.1. Objectives

Data from both ironworks and steelworks are included in the study and divided into blocks which correspond to the process steps. The main objective is to identify, visualize and quantify process disturbances at the plant by modelling each block and also connect data from the iron- and steelworks using hierarchical modelling. The top-level model is based on the models for each of the data blocks.

The process disturbances may cause faults such as non-satisfactory and varying crude iron composition, slopping during basic oxygen steelmaking, failure reaching the liquid steel product specification and quality problems while casting. The aim is to describe these disturbances well enough for actions to be taken.

1.2. Scope

The process equipment at different steelworks may vary from each other, therefore the theoretical description of steel production as well as literature and papers studied are mostly for process lines similar to the one at SSAB Oxelösund. The term process line is here used for the five steps *crude iron production, desulphurization, basic oxygen steelmaking, secondary steelmaking and continuous casting*.

SSAB Oxelösund produces a variety of steel qualities. Internally these are named T-sorts, each having its specific process route and quality specification. Three T-sorts have been included in the data studied (in this study called T1, T2 and T3), constituting common products with challenges meeting quality targets, especially in the casting step. Although the T-sorts do not have exactly the same properties, they are included in the same dataset for comparison.

A wide range of phenomena and correlations in the process line may be studied using multivariate techniques, but focus in this study is to identifying factors affecting the quality targets in each process step and thereafter to quantify their influence. The quality targets are illustrated in figure 15 in section 3.1.3.

2. Theoretical background

In this chapter the tools used for data analysis are presented together with a description of the steelmaking process in general and the SSAB Oxelösund steelworks in particular.

2.1. Multivariate statistical methods

The aim for multivariate analysis is to present useful information from large amounts of data that may be difficult to grasp in more traditional ways. The methods used in this study are based on the idea of latent structures available in the original data.

The concept can be illustrated by a comparison with the human colour vision as is done by Martens and Naes (1991), see figure 1. The sunlight consists of several wavelengths, of which the ones between 400 and 700 nm are what we call visible light. If these wavelengths encounter a red cloth, the “red” (600–700 nm) are being reflected and eventually registered by the human eye, which registers the information as the three quantities red/green, yellow/blue and light/dark and passes this information on through nerve cells. Even though the incoming light consists of tens or more wavelengths, three variables (together with information about the light source’s original spectra, which the brain is aware of) is enough to produce meaningful colour information. These three pairs are in this case the latent variables that the incoming spectra are compressed into.

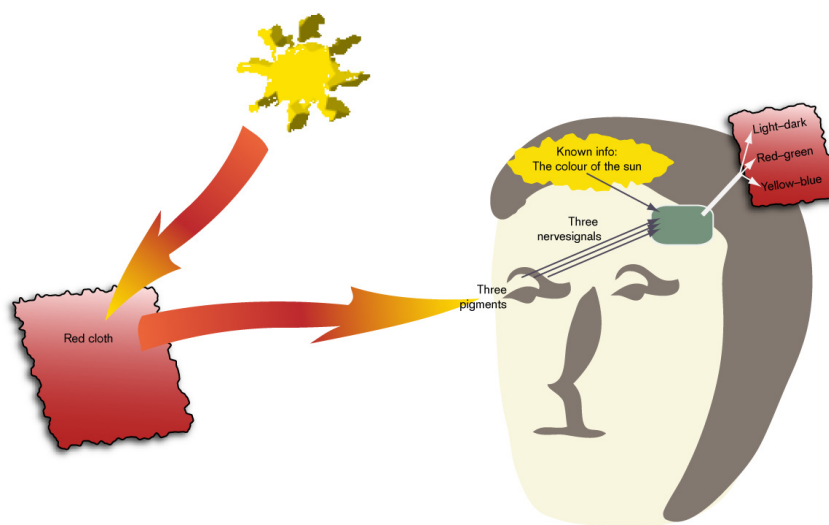

Figure 1. Colour vision as an illustration of latent variable construction. The sunlight consists of hundreds of wavelengths. The red wavelengths are reflected by the red cloth and captured by three pigments in the eye. Three nerve signals pass on the wavelength information to the brain which calculates the three-dimensional colour space.

In this study two latent variable methods have been used to model the different process steps at SSAB Oxelösund; principal component analysis and projection to latent structures (also known as partial least squares). A common thing with these methods is that they produce models that are more compact and statistically stable than the data matrix X (Martens & Martens 2001). In addition, results from the individual models have been implemented in a top model by hierarchical methods, described in subsection 2.1.3.

2.1.1. Principal component analysis (PCA)

Several objectives may be the background for using principal component analysis (PCA). Wold et al (1987) lists some of them in their PCA tutorial: simplification, data reduction, modelling, outlier detection, variable selection, classification, unmixing and prediction.

Using PCA to construct the latent variables out of a data matrix X is basically a task of least squares calculation. The different observations made are stored as rows (often called objects) in X and the variables measured constitute the columns. The main patterns in the data in X are captured in a few principal components (PCs), stored in the small matrices T and P' . The column vectors in T carry information about patterns in the observations while the rows in P' are related to the variables and their individual contributions to the principal component. Plotting is usually a good tool to visualize the information achieved in the PCs.

$$\begin{bmatrix} x_{11} & \cdots & x_{1K} \\ \vdots & \ddots & \vdots \\ x_{N1} & \cdots & x_{NK} \end{bmatrix} = \begin{bmatrix} t_{11} \\ \vdots \\ t_{N1} \end{bmatrix} \begin{bmatrix} p_{11} \\ \vdots \\ p_{K1} \end{bmatrix}' + \cdots + \begin{bmatrix} t_{1A} \\ \vdots \\ t_{NA} \end{bmatrix} \begin{bmatrix} p_{1A} \\ \vdots \\ p_{KA} \end{bmatrix}' + \begin{bmatrix} e_{11} & \cdots & e_{1K} \\ \vdots & \ddots & \vdots \\ e_{N1} & \cdots & e_{NK} \end{bmatrix}$$

Figure 2. Matrix notation for a schematic extraction of data matrix X into A principal components and residual matrix E .

The PC's can be calculated in a iterative manner using the NIPALS (non-linear iterative partial least squares) algorithm. The vector t_i ($i = 1 \dots A$, where A is the number of components calculated) is called the score vector and p_i is denoted loading vector. Geometrically the principal component may be interpreted as the straight line best fitted to the N data points in a space spanned by K variables.

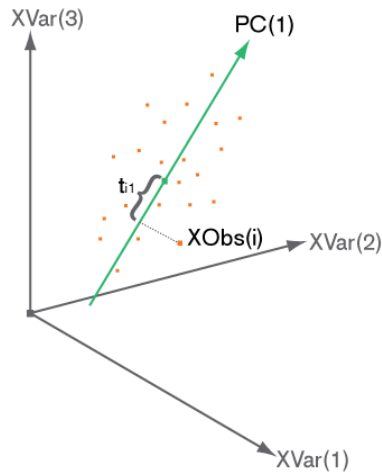

Figure 3. The score t_{ij} is the orthogonal projection of the j th observation onto the axis of the i th principal component. The loading vector p_i contains the direction coefficients for the PC.

The slope of the PC reveals the direction of maximal variance. The following components will be orthogonal to the previous ones, and by calculating $A = \min(K, N)$ components a whole new set of axes are constructed, i.e. a coordinate system transformation has been made. However, when using PCA in studies like this, there is no meaning in taking too many components since the observations and variables contain noise. Meaningful information is only available in the first few components and using too many PC's would only spoil the opportunity to classify or predict future observations.

Data pretreatment

Before the PCA is performed on the data matrix X it may be necessary to do some transformations, centring and scaling of data. These three steps are not performed by routine but depend on how input data looks.

Transformations may be used to correct for nonlinearities in original data. A common transformation is to take the logarithm of the X -values, but there is a lot of various specialized methods available. If different transformations are applied to the variables there is a risk for introducing a shear between the correlation matrix for X and the one for the transformed data set (Wold et al 1987).

Centring around each variable's mean is used to achieve more stable computations. Since PCA is used to model the variation between the objects, centring will not influence the interpretation (Martens & Martens 2001). The relation between original data and the principal components may then be written as $X = 1\bar{x} + TP' + E$, where 1 is a $K \times 1$ column vector only containing ones.

Scaling is used to compensate that some variables may have larger absolute values than others, thereby giving each variable possibility to contribute equally to the PC's. Usually scaling is performed by dividing each value with the standard deviation of the respective variable. In some cases scaling is not suggested, e.g. when modelling absorbance data the variables (wavelengths) are all of the same kind and scaling would have severe effect on the loadings p calculated.

Another pretreatment operation may be to create new variables, e.g. differences or ratios, calculated from the variables already present. Also, handling of missing data must be taken care of since all process data is not registered for all times. This may for example be due to transmission failures between sensor and database.

In the present study, centring, scaling and creation of new variables have been used but no transformations. Missing data has been handled by an algorithm which is a part of the software used for modelling¹.

Model validation

When the model has been calculated it is important interpret it and to perform a proper diagnose where its accuracy and other quality aspects are validated. In order to do that, several statistical tools and useful plots can be calculated and studied. A first overview normally includes checking the amount of explained variance R^2 and the amount of variance that the model is able to predict (often denoted Q^2 or $R_{prediction}^2$). These two properties vary between 0 and 1 where unity indicates a good performance. They are calculated as follows:

$$R^2 = \frac{SS_R}{SS_T} = 1 - \frac{SS_E}{SS_T}$$

where SS_R is the explained sum of squares, SS_T is the total sum of squares and SS_E is the residual sum of squares. If the degrees of freedom are accounted for, the so called adjusted R_2 can be calculated:

¹ Simca-P+ 11.5 from Umetrics AB, Umeå, Sweden.

$$R_{adj}^2 = 1 - \frac{\frac{SS_E}{K-A-1}}{\frac{SS_T}{K-1}} = 1 - (1 - R_2) \frac{K-1}{K-A-1}$$

where A is the number of components and K is the number of variables (if the number of observations, N , are less than K then N should be used instead of K). The R_{adj}^2 is used due to the fact that R^2 increases with every new component calculated, even if it does not model any important variance. R_{adj}^2 is able to compensate for the fact that a new component has been calculated and will only increase if more variance than would be expected from random noise is explained (Montgomery 2001).

$$Q_2 = 1 - \frac{PRESS}{SS_E}$$

where SS_E is the residual sum of squares of the previous component (i.e. in correspondence with the amount of variance remaining to be explained) and $PRESS$ is the prediction error sum of squares which is calculated as the sum of squares of the difference between real X -values and predicted ones:

$$PRESS = \sum_{i=1}^N \sum_{j=1}^K (x_{ij} - \hat{x}_{ij})^2$$

The predicted value \hat{x}_{ij} is achieved by cross validation (CV) which also is a tool for determining the number of significant components in the model. It can be done in several ways but is based on the idea of excluding some of the data, calculating a new model, use that model to predict the excluded values and then comparing the excluded and compared values when all data have been excluded one (and only one) time. In the software Simca-P+ used for modelling in this study, observations are first excluded for loadings to be calculated, then variables are excluded and scores calculated. The ratio $PRESS/SS_E$ is then used to determine if the component calculated is significant – a ratio smaller than unity indicates that the predictive ability has increased with the last component (Montgomery 2001). Q^2 may be calculated for a component, a variable in a component (Q_{var}^2) or summed for all components, denoted Q_{acc}^2 . Depending on whether trends in the data exist or not, the way the cross validation blocks are chosen is of importance for the calculation of Q^2 .

The relevance of the variables is for example determined by looking at the amount of explained variance. A measure for that is the modelling power, $Mpow$, where the residual standard deviation for variable k is related to the initial standard deviation for the variable (Umetrics 2002):

$$Mpow_k = 1 - \frac{\sigma_k}{\sigma_{k0}}$$

Plotting $Mpow$ for all variables enables good comparison of variable relevance. Excluding variables is however generally not recommended since removing the variable may seem to improve model properties but in reality that is not always true. Also apparently non-significant variables will contribute to the observations residuals or distance to model ($DmodX$, described in next subsection) (Wold 1987).

Plots and interpretation

The first principal components calculated reveal most of the information that can be readily interpreted. A first look at the data will therefore be to plot the scores and loadings, see figure 4 (a, b, c).

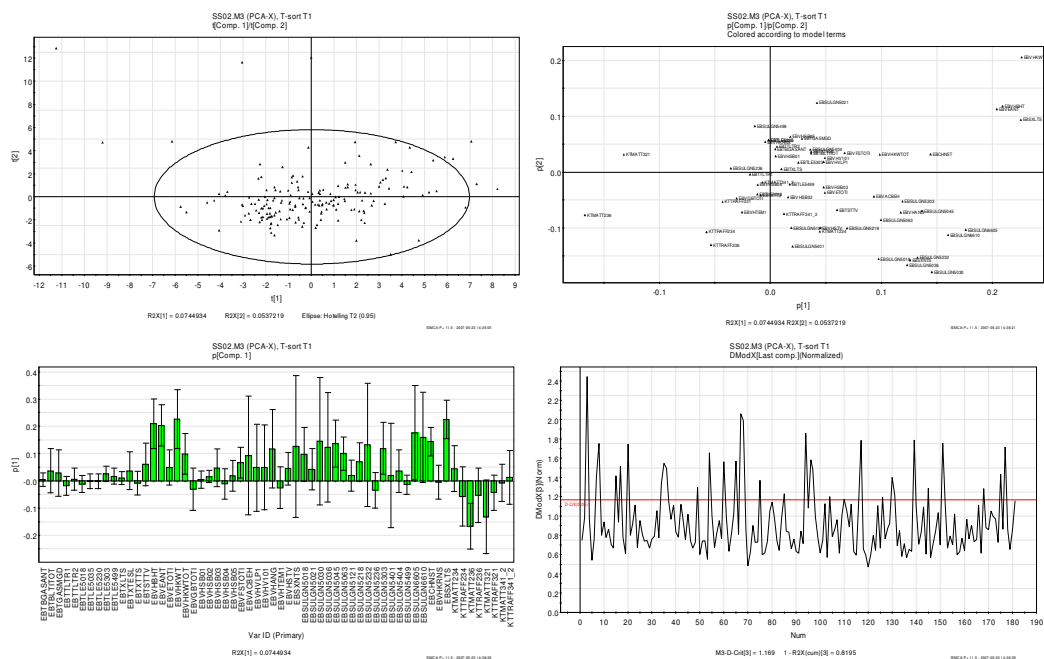

Figure 4. Upper left (a): Score scatter plot. Upper right (b): Loading scatter plot. Lower left (c): Loading column plot. Lower right (d): Distance to model plot.

Scores. The score plot describes the observations and can help to find classes of objects and objects that are similar, but also non-similar and opposite objects. The score plot is also often a useful tool to identify outliers. The ellipse shown in figure 4 (a) is a significance limit for Hotelling's T^2 and marks the largest distance from origin an object may have in order to statistically belong to the model. Any object outside this range may be an outlier but should be investigated further before it is excluded from the model calculation.

Loadings. Valuable information about which variables have most influence on the scores can be gathered from loading plots. For example; by comparing figure 4 (a) and (b) it can be noted that the variables in the upper left and lower right parts of the loading scatter plot are connected to the outlying observations in the score scatter plot. Subfigure (c) clearly shows important variables in the first principal component. Loadings for variables where the standard error indicator bar crosses zero should not be treated as significant in the model. It should be noted that the individual principal components in general does not necessarily model a specific variable but rather captures the direction of most variance orthogonal to the previous direction. However, it is often the case that some phenomena are modelled in each component.

Distance to model. Figure 4 (d) shows a plot of the distance to model-measure for each observation in the X -matrix (denoted $DModX$ in Simca-P+), i.e. the original object's distance to the model. $DModX_i$ is the same as the standard deviation of object i 's residual, σ_{e_i} , but often a normalized variant is used where it is related to the standard deviation of the whole model's residual, σ_{model} . The statistic

$$\left(\frac{\sigma_{e_i}}{\sigma_{model}}\right)^2$$

is approximately F-distributed and the limit for significant model membership is shown in the plot as D-crit (red line). It is possible to identify possible outliers in the *DModX*-plot that is not shown outside the Hotellings T^2 -range in the score plot, due to the fact that an observation may lie far from the model but still be projected close to origin in the score plot. However, the *DModX*-distance for an outlier should be at least two times the D-crit value (Umetrics 2002).

Leverage. An observation's influence on the model may be quantified using the leverage measure. This may for example be important in determining observations that have rotated the model hyper-plane (high leverage points located far from a principal component). The observation leverages are the diagonal values of the H-matrix (Montgomery 2001):

$$h_{ii} = \text{diag}(H) = \text{diag}(T(T'T)^{-1}T') \quad i = 1 \dots N$$

Predictions. New observations may be classified by the computed model using the loadings to calculate scores for the new objects. Plotting all the scores may then reveal relational information between the new objects and the ones that were used to create the model. The distance to the model may also be calculated for the new observations.

2.1.2. Projection to latent structures (PLS)

PCA is a useful tool for classifying and to get an overview of a set of observations characterized by many variables. However, if the variables in this data set X , can be seen as the causal ones for some measurable property or properties Y , it would be desirable to describe Y as a function of X . A robust and orthogonal method that is frequently used for this purpose is PLS, projection to latent structures (Geladi & Kowalski 1986, Renman 1998). The power of PLS is that principal components are calculated for both the independent variables in the X -block and the dependent ones in the Y -block, while trying to describe as much of the correlation between X and Y as possible (Martens & Martens 2001). Schematically, the procedure may be written as:

$$\begin{aligned} X &= 1\bar{x} + TP' + E \\ Y &= 1\bar{y} + UC' + F \end{aligned}$$

where U is the scores for the Y -block which are related to the X -block scores as $U = bT$. C is loading matrix for the Y -block and describes correlation between Y and T . There is also a set of loading weight vectors w^* , collected in matrix W^* , which describes the influence of each X -variable on the Y -scores U , i.e. the balance between X and Y^2 . When calculating the components a certain PLS algorithm is frequently used. If the Y -block consists of just one variable the algorithm is denoted PLS1, otherwise it is called PLS2 (Renman 1998). Once the components are calculated, it is possible to find the regression coefficients B as:

$$Y = 1\bar{y} + XB + F$$

The X -block of the model may then be analysed to check the goodness of the fit and outlier detection as stated in the text about PCA (section 2.1.1, both model validation and plotting). However, a perhaps better choice is to first get an overview of the X -variables

² In Simca-P+, w denotes the weights that combine the residuals of the X -variables and the Y -scores, while w^* are the weights between the original X -values and the Y -scores.

with a PCA-model and make necessary adjustments of the data set (i.e. observation removal or transformation – without removing useful information for the response variables) before starting to build a PLS-model.

Plots and interpretation

Once the PLS model has been fit it is necessary to check how well it describes the relation between X and Y . Statistics such as R^2 , Q^2 and distance to model ($DModY$) are available also for the Y -block and indicates explained variance among the dependant variables. Variable importance for the projection, VIP, is a measure of the variables capability to describe X and relate to Y and is calculated as the square of the loading weights w , weighted with the amount of explained Y -variance (SS_R) for each component (Umetrics 2002).

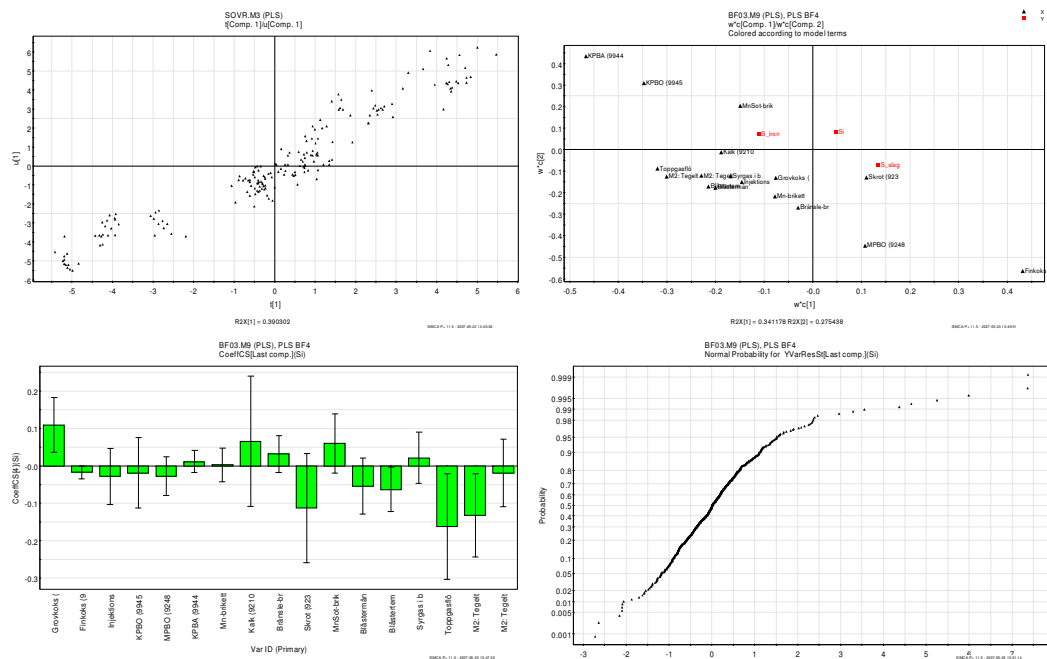

Figure 5. Upper left (a): Score scatter plot (t against u). Upper right (b): Loading weights (w^*c). Lower left (c): Regression coefficients plot. Lower right (d): Normal probability plot.

In figure 5 four useful plots are shown:

- In (a) t against u are plotted – in ideal cases this should give a perfect straight line, indicating full correlation between the X and Y scores and therefore good predictive ability.
- Plot (b) shows the relations between the X -variables and the Y -responses. This is done by plotting the loading weights w^* together with the weights for the Y -responses, c , and gives valuable information about important x 's for the different y 's.
- The regression coefficients shown in (c) may reveal information about the correlation between Y and the informative part of each X -variable. However, they do not carry any causal information unless design of experiments has been performed. This is due to the coefficients being dependent to each other and the Y -value will not change as much as each coefficient says.
- The plot in (d) is the normal probability plot which shows each observations standardized residual ($\frac{e_{obs}}{\sigma_e}$). Observations with a standardized residual larger than four (absolute number) should be considered as an outlier. (Umetrics 2002)

Predictions

Once the model has been fit and analysed it is important to check its predictive ability for unknown observations. The cross validation of course gives a good indication of the model accuracy but since that is a kind of internal validation procedure where data from the original dataset are used, it is recommended to perform external validation as well. The data used to build the model is often called training-set or calibration-set, while the data for prediction validation is named test- or prediction-set. Of course it is necessary to measure the Y -responses for the prediction-set by some standard method in order to be compared predicted and “true” values.

The procedure for prediction testing is rather straight-forward. The X -block scores, t_{pred} , for the prediction-set are calculated using the model loadings, thereafter Y -scores, u_{pred} , are calculated and then the Y -responses are obtained as $Y_{pred} = U_{pred}C^T$. Comparison of predicted and observed values and the residuals for training- and test-set may then give indications of the model performance. A useful tool is to plot observed responses against predicted, see figure 6.

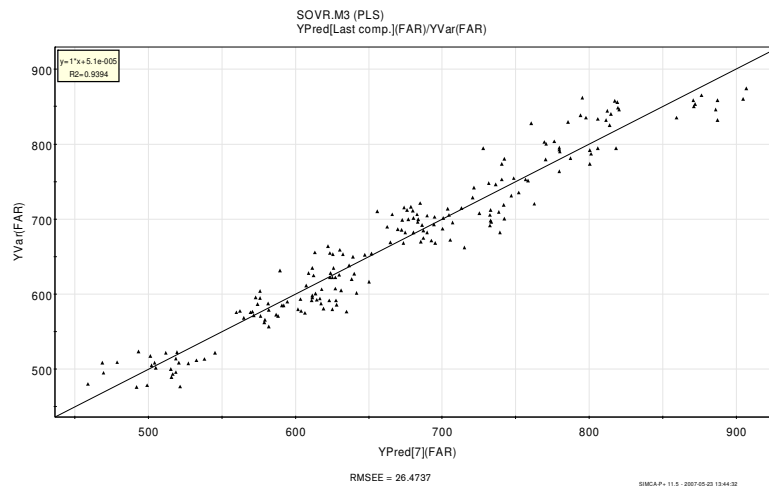

Figure 6. Predicted Y -values for observations plotted against observed Y -values for the same observations.

Another useful plot is the so called observation risk which shows the ratio between the observation residual for a predicted object and the observation residual for the same object when included in the model ($\frac{e_{obs}(pred)}{e_{obs}(model)}$). This is calculated for all the Y -variables and a value at 1.5 and above indicates that the observation influences the predictions very much when included in the model.

In order to quantify the predictive error, the root mean-squared error of prediction (RMSEP) may be calculated:

$$RMSEP = \sqrt{\frac{\sum_{i=1}^N (y_i - \hat{y}_i)^2}{N}}$$

This is a very useful number which has the same unit as the response itself, thereby indicating the size of the error. It is also possible to compare RMSEP with the standard error for the analysis method used when measuring the “true” (observed) values (Martens & Naes 1991, Andersson et al 2004).

2.1.3. Hierarchical modelling

Although multivariate modelling techniques certainly are able to handle a lot of variables and build proper models with only a few dimensions, there are situations where dividing the data into blocks may improve modelling capabilities. For example, model results from a PCA of a process line with variables from different steps may be difficult to interpret due to lack of simple structure of the principal components. Dividing the variables into logical and meaningful blocks may lead to better models and the ability to build a super level model based on the scores from the underlying models, describing common variation and relationships between the blocks (Wold et al 1996).

Figure 15 in section 3.1.3 shows the setup in the present study where five process steps in the iron- and steelworks make up the five blocks. The process steps are described in the next section. The figure also reveals the ability to zoom in from the top-level to the block levels, e.g. determining which blocks and variables are most important for the desired product properties (Umetrics 2002).

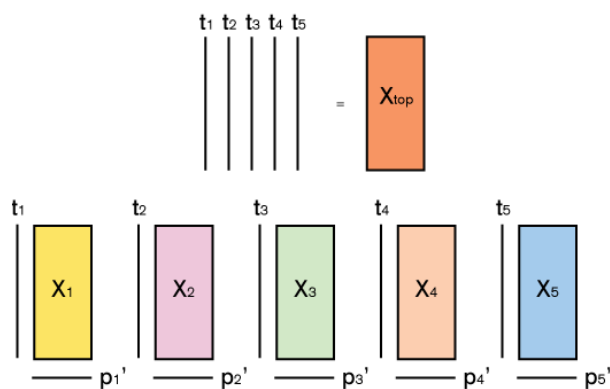

Figure 7. The principle of hierarchical modelling where the scores from the block models constitute the data for the top model.

There exist several different theoretical approaches for hierarchical PCA and PLS modelling. In this study, the implementation available in Simca-P+ has been used, where the scores from the base models form the data for the super level as can be seen in figure 7. A more detailed theoretical background for multi block and hierarchical modelling are among others given by Qin et al (2001), Smilde et al (2003), Westerhuis (1998) and Wold et al (1996). The latter also gives an example of a real application.

2.2. Steelmaking

The process of iron- and steelmaking in general and the steelworks at SSAB Oxelösund in particular is here described. Some extra attention is made to phenomena that have been challenging or interesting in this study. It should be noted that steel may be produced in other ways than is explained here; the process described is iron ore based production and steel refining with equipment used at SSAB Oxelösund as well as many other modern steelworks.

Information about steelmaking has been gathered from an educational package in Metallurgy from Jernkontoret (2000), Ullman's (2005), Nationalencyklopedin, AISE (1998, 1999), Thorén et al (2004), Steeluniversity.org and Atkins & Jones (2002). A visit at SSAB Oxelösund has also been made.

2.2.1. Overview of the process

A modern steelworks consists of a series of process steps where crude iron is gradually refined to steel of a certain quality and casted in a continuous manner into large pieces, e.g. rectangular slabs, which are treated further in the rolling mill. The crude iron is produced in the blast furnace by reduction of iron ore.

SSAB Oxelösund is a world leader in manufacturing wear resistant plates of high quality quenched and tempered steel and is one of Sweden's two remaining facilities using the blast furnace for crude iron production (the other one is located in Luleå at SSAB Tunnsplåt). The production line also contains a coke plant supplying the blast furnaces with reduction agent.

This study is limited to the crude iron production and steel refining, i.e. the five steps marked within the frame in figure 8.

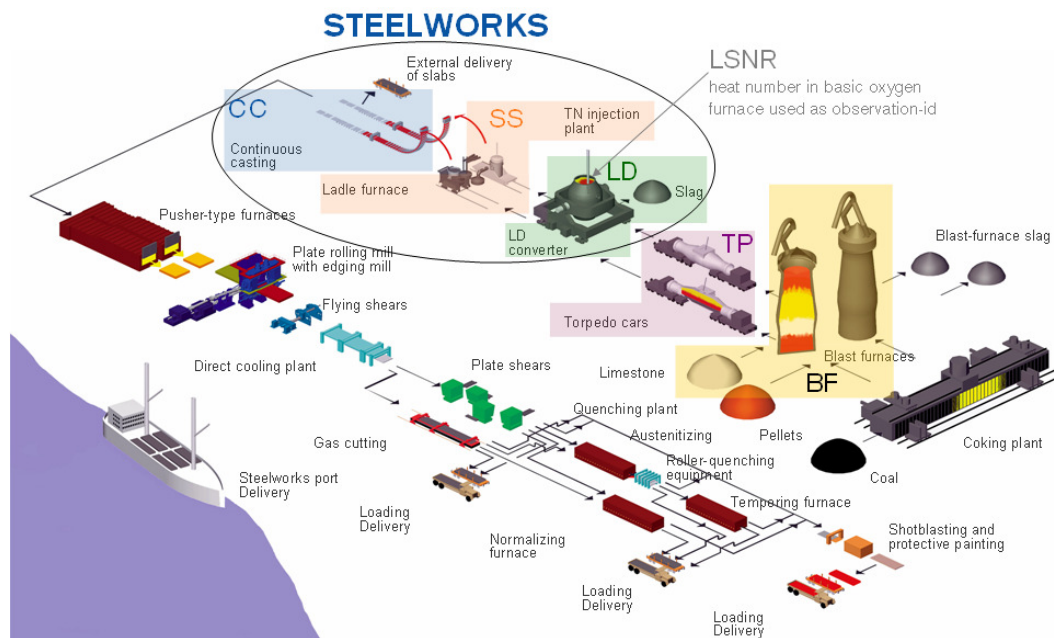

Figure 8. SSAB Oxelösund process line overview.

- Ironworks
 - Crude iron production: Blast furnace
 - Desulphurization: Torpedo cars
- Steelworks
 - BOS, Basic oxygen steelmaking (LD–LBE-converter)
 - Secondary steelmaking (TN station and ladle furnace)
 - Continuous casting

The production in the blast furnace may be treated as continuous while the subsequent steps are batches (named as *heats*). Several different properties are to be considered during production, especially composition of the liquid metal. These properties are summarised in a T-sort which is used as a production target and contains information such as external and internal quality of the steel and maximum, minimum and aim content of various alloys and other compounds. Other quality terms are also used, e.g. to ensure that the steel quality ordered by the customer is met. Analyses are performed at several steps in the process to

verify that the current heat is within the specifications. A description of each step is given in later subsections, but first basic thermodynamic and kinetic aspects on the crude iron and steel manufacturing are presented.

2.2.2. Thermodynamics and kinetics

In order to perform the ore reduction and steel processing in the desired direction it is necessary to be able to predict the behaviour of the participating components. Thermodynamic laws will determine which reactions that occurs and which that doesn't. Three important factors affecting metallurgical thermodynamics are:

- Oxygen potential
- Composition of the slag
- Temperature

At first, the oxygen potential must be low in order to reduce the ore. This is well achieved in the blast furnace where the oxides present in the ore is reduced stepwise not only to elemental iron, but also to several other metals (such as silicon, Si; manganese, Mn and phosphorous, P). In addition the hot metal becomes saturated with carbon in the last part of the blast furnace, making its oxygen potential lower than that of the final steel.

Figure 9 shows the large decrease in oxygen potential achieved in the blast furnace. It also illustrates that subsequent process steps adjust the level in further steps. After discharge from the blast furnace, the crude iron is cleaned from sulphur when the oxygen potential is low. Thereafter the level is raised in order to remove carbon, phosphorous, silicon and manganese. Finally deoxidation is performed in order to achieve low oxygen content in the steel before casting.

The slag produced in the different steps is used as a tool for creating favourable conditions for desired reactions. In order for the slag to form fast enough, slag formers such as lime (CaO) and dolomite (CaMg(CO₃)₂) are added. In the blast furnace the slag mainly consists of lime, silica (SiO₂), dolomite and alumina (Al₂O₃) while in the steelworks CaO, SiO₂ and ferrous oxide (FeO) are the major constituents. While refining the iron or steel, the slag is normally used as recipient of the unwanted compounds. Two frequently used techniques for removing impurities are precipitation, and diffusion. In precipitation a reagent is added to the liquid metal and the product it forms with the target specimen is taken up by the slag. Diffusion techniques are based on improving the equi-

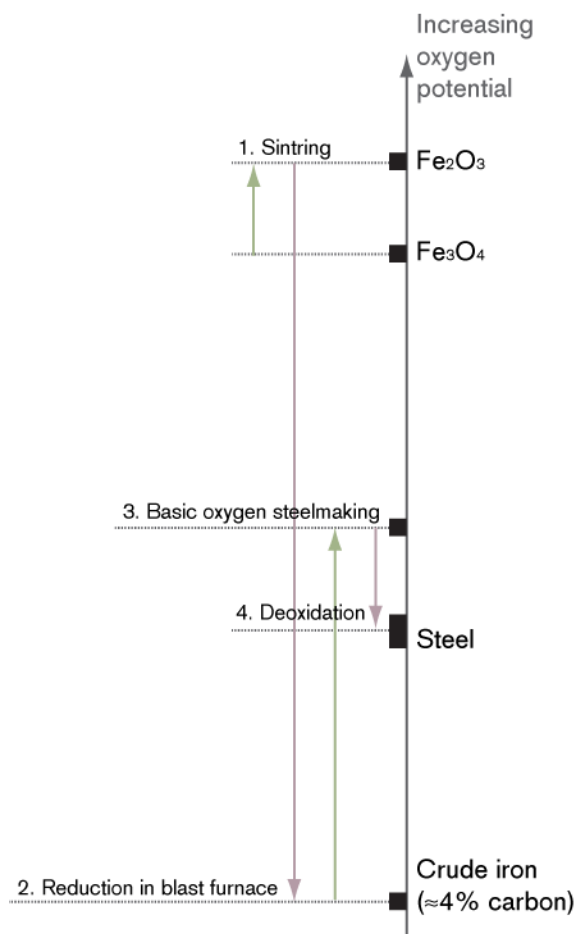

Figure 9. Changes in oxygen potential of the hot metal during its way through the iron- and steelworks.

librium concentrations between slag and metal in advantage of the slag. In either technique it is important to optimize the kinetics and mass transfer between molten metal and slag. This may be achieved by:

- Agitation performed either by bubbling inert gas through the bottom of the vessel with the liquid steel or through a lance.
- Temperature adjustment, e.g. by treatment in a furnace.
- Pressure adjustments, e.g. by vacuum treatment.

Another useful aspect of the slag is that its lower density makes it float on top of the liquid metal and thereby protecting the latter from heat losses and dissolving gases such as nitrogen, hydrogen and oxygen which are detrimental to the steel during casting.

2.2.3. Crude iron production: Blast furnace

The crude iron is produced from iron ore by redox reactions with carbon and carbon monoxide in the blast furnace. Iron ore in the form of pellets and briquettes are placed on the top of the furnace together with coke and slag formers such as limestone (CaCO_3) and recycled slag from the steel manufacturing (LD-slag). This is called a charge. At the bottom part of the furnace a hot air blast enters and reacts with the coke (and coal, which is injected at this stage) to form massive amounts of carbon monoxide which makes its way up through the solids. While the solid materials descends down the shaft the iron ore is step-wise reduced and can eventually be discharged as elemental iron at the bottom, where the temperature of the solids reaches up to 1800°C .

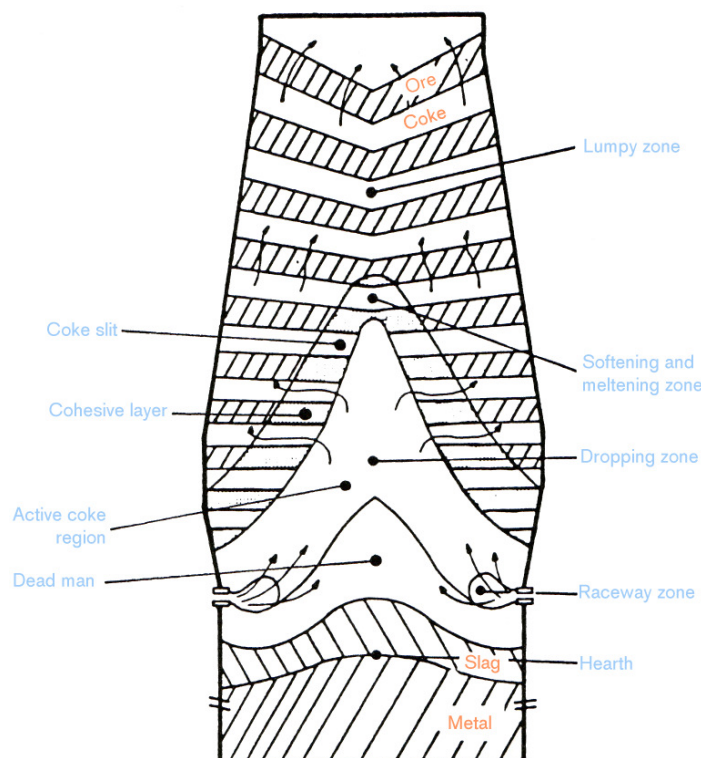
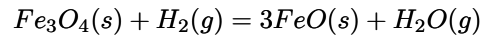
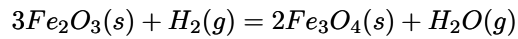
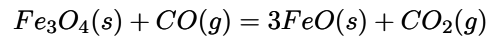
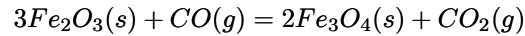

Figure 10. Schematical drawing of the blast furnace. (Bi 1989)

Basically the blast furnace can be seen as a counter current reactor as in figure 10. In the upper part the gas gives much of its residual heat to the solids which reaches a temperature

slightly below 1000 °C – this is called the lumpy zone (or preheating zone). It is also here that the first iron ore reduction reactions occur:



Thereafter the softening and melting zone, having constant temperature, follows. Here some of the ferrous oxide is reduced to elemental iron and lime is formed from the added limestone:

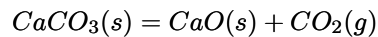
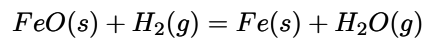
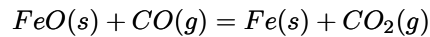

In the zones mentioned, constituting the major part of the furnace, the reduction agent is carbon monoxide (or hydrogen) and the reactions are also named indirect reduction. In the next zone – the direct reduction and dropping zone – the temperature is high enough for the melted FeO to react with the coke or coal directly, producing elemental liquid iron (Bi 1989):

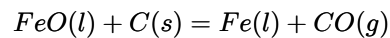

Other oxides that reside in the ore pellets are also directly reduced and sulphur (originating from the coke but in the form of elemental sulphur or iron sulphide, FeS) is partly removed by lime:

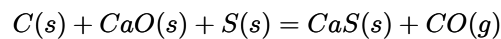

Many of the metal reduction reactions are endothermic. The energy is supplied when the coke and coal is combusted by help of the hot air blast, resulting in a gas temperature above 2000 °C. The air enters the furnace in the so-called raceway; through water-cooled copper tuyeres (a pipe through which air blast can be forced into the shaft) and has a temperature around 1000 °C. Before entering the furnace the air is heated in a regenerative heat exchanger which is heated by flue gases from combustion of the cleaned blast furnace off-gas.

The residence time in the furnace is only about 30 seconds for the reduction gas, while the solids (and later on the melt) need several hours to descend through the shaft. Tapping of the liquid crude iron and the slag is done for about two hours, and then the hole is plugged for about an hour. The crude iron temperature at discharge is about 1450°C. Separation of iron and slag is made on mechanical way using the difference in density between the phases. However, some slag will still be carried over to the crude iron.

Important parameters

It is generally difficult to measure what is really going on in the furnace shaft, for example due to the rough environment and high temperature. Analysis of the final hot metal and slag is made after tapping, but since the residence time is several hours it is not possible to

directly control the process. The operations are striving to run the furnace with as little variation as possible.

The production can be controlled by the way the solid raw materials are added on the top. This will influence permeability which should be high enough to ensure good flow of reduction gas and can be estimated by measuring the pressure drop from bottom to top. Other important control factors affecting the process may be to vary the blast air volume, temperature and moisture content. Disturbances in the shaft's cross section can be identified by analysing the furnace off-gas for temperature and composition which indicates that gas channels or aggregates are present in the furnace.

Although the blast furnace process is very old there are still potential for improvements. Disturbances may for example lead to variations in silicon content in the hot metal which may affect the refining in the LD-converter.

2.2.4. Desulphurization: Torpedo car

The hot metal is tapped into a large vessel wagon called torpedo (due to its shape), which may carry 325 tonnes of hot metal. The torpedo is used as a buffer between blast furnace and LD-converter – which is where the actual steelworks begins. Remaining sulphur is also lowered to desired level in the torpedo by addition of a reagent with strong affinity to sulphur – usually calcium carbide (CaC_2), lime, magnesia or a mixture thereof – injected in the vessel through a ceramic lance. The incoming sulphur concentration may vary between 0.005 mass-% and 0.2 mass-% and is reduced to 0–0.02 %. The product (i.e. CaS) forms a slag which floats on top of the liquid metal.

To ensure that a sufficiently low sulphur concentration has been reached an analysis is made on the hot metal and if necessary extra reagent is added. If the analysis result is within the limits the crude iron is being poured into a ladle that is transported to the LD-converter. The slag is removed by mechanical means.

2.2.5. Basic oxygen steelmaking: LD-LBE-converter

As can be seen in figure 9 the oxygen potential is greatly increased in the converter. This is done mainly to reduce carbon, phosphorous, manganese, silicon and vanadium content and increase temperature in the melt, see figure 11. The raw material for the conversion process is crude iron from the torpedo, steel scrap (to utilize and stabilize the increased temperature and improve yield), slag formers and oxygen. The product is crude steel with an approximate target temperature of 1680 °C, which is then refined to the desired quality in the secondary steelmaking before casting takes place.

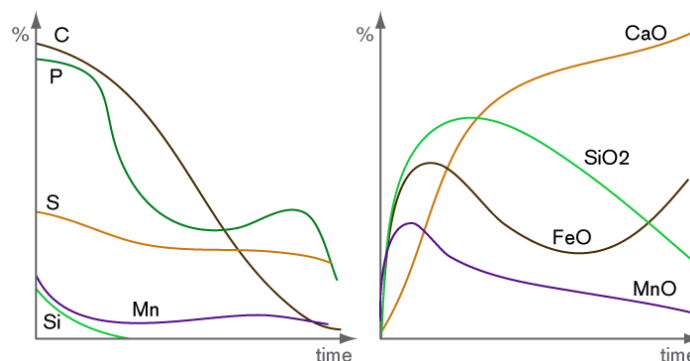
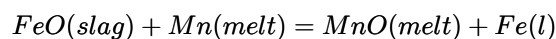

Figure 11. Idealized changes in composition during basic oxygen steelmaking in the LD-converter.

The furnace is called LD–LBE-converter, where LD is short for Linz and Durrer, the former being the city where the reaction vessel was first installed and the latter the surname of its Swiss inventor³. LBE is short for lance–bubbling equilibrium and refers to the possibility of bubbling inert gas (argon or nitrogen) through the bottom of the vessel, improving the agitation. Through the lance, pure oxygen is blown into the vessel, creating a highly oxidizing potential.

Based on an analysis of the liquid crude iron in the incoming ladle, an optimal program for the conversion process is calculated by a heat model which also suggests amounts of scrap, slag formers and oxygen to add. The scrap is added first and then the hot metal, thereafter the lance is lowered and starts to blow 99.5 % pure oxygen into the vessel. This causes several of the compounds to oxidize, where silicon and manganese are the first ones (not to mention iron, which makes up 94 mass-% of the hot metal). The SiO₂-formation is highly exothermic and contributes a lot to the increase in temperature, allowing the scrap to melt. Carbon and phosphorous oxidation also give large contributions to temperature increase. The silica forms the first slag together with MnO and FeO and lowers the melting point for the added slag former CaO. In figure 11 it can be seen that manganese concentration increases when the silicon oxidation is complete. The high temperature reduces MnO in the slag by carbon, but during the end of the blow the Mn-concentration decreases again due to a reaction with ferrous oxide:



Phosphorous oxidation is affected negatively by increased temperature which explains why phosphorous content increases at the middle period of blowing. The concentration of FeO in slag increases greatly at the end of the blowing when most of the Si, Mn, C and P have been oxidized.

When blowing is over (about 25 minutes) a sample is taken from both the metal and slag. If the concentrations and temperature are acceptable the steel is tapped into a ladle. Care must be taken not to carry over slag from the converter to the ladle, which otherwise would bring impurities to the steel that are very hard to remove (especially re-reduction of phosphorous and vanadium). Also, deoxidation agents such as ferrosilicon (containing iron silicide, FeSi) and aluminium are added to lower the oxygen level.

Important parameters

The converter is mainly controlled by changing lance height, oxygen blowing and bottom bubbling with argon and/or nitrogen. The process program chosen is dependant on start and target values for metal composition and temperature. Most crucial during operation is to avoid that the ferrous oxide rich slag – which is very foamy – builds up to high and leaves the vessel. Such an occurrence is called slopping and causes loss of raw material and hazardous gas discharge. Several attempts to predict and control slopping have been made with varying levels of success.

2.2.6. Secondary steelmaking: TN-station and ladle furnace

The converted steel is relatively rich in dissolved oxygen and other gases such as nitrogen and hydrogen which must be removed. It will also need adjustments in alloy concentrations which can be done in a variety of equipments and by a range of additions to reach the target analysis for the steel. Gas bubbles or slag inclusions decrease the strength and toughness of the finished steel which is detrimental for quality aspects. Gas removal may be done by agitation and vacuum treatment, although oxygen is often precipitated by a reagent ad-

³ According to Sethur (1960), D in LD may also stand for Düsen, which is Voest's patented jet for oxygen blowing, or Donawitz, which installed the LD-converter shortly after Linz.

dition such as FeSi or Al as is done when the LD-converter is emptied. Slag inclusions consist of oxides or sulfides originating from the slag, refractory lining or precipitation reactions.

At SSAB Oxelösund there are two stations used for these types of treatment: TN-station (Thyssen Niederrein or *trimningsstation*) and the ladle furnace (SU, *skänkugn*). The TN-station is a rather simple step and gives the opportunity for the following refining steps:

- Desulphurization.
- Homogenisation by argon flushing through a ceramic lance or porous plugs in the bottom.
- Alloy addition to meet the demanded analysis and scrap addition to decrease temperature.
- Addition of CaSi-wire combined with argon flushing to reduce inclusions. Silicon binds strongly to oxygen and calcium may react with either oxygen, sulphur or alumina inclusions:
 - $Ca(steel) + O(steel) = CaO(slag)$
 - $Ca(steel) + S(steel) = CaS(slag)$
 - $Ca(steel) + (n + 1/3)Al_2O_3 = CaO \cdot nAl_2O_3 + 2/3Al(steel)$
 - $CaO(incl.) + 2/3Al(steel) + S(steel) = CaS(incl.) + 1/3Al_2O_3(incl.)$

The ladle furnace is a comprehensive piece of equipment. In addition to the tools available at TN there are several alternatives for refining:

- Efficient degassing can be achieved by vacuum treatment while flushing argon into the liquid steel from the bottom of the vessel.
- Heating possibilities by a set of electrodes creating electric arcs.
- Stirring possibilities by electromagnetic induction for homogenization and slag inclusion modification purposes. Stirring is also important for degassing since the ferrostatic pressure is about two atmospheres at the bottom of the ladle and would cause too large portions of gas to remain in the liquid steel if there were no circulation in the ladle.

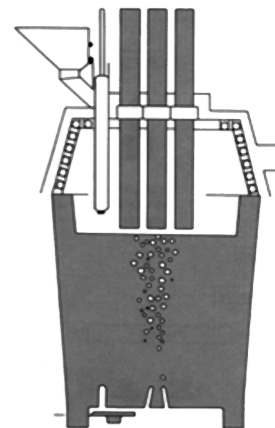

Figure 12. Ladle furnace. (Ullmans 2007)

Once the analysis shows that the steel meets ordered quality the ladle is transported to the casting machine.

2.2.7. Continuous casting

Good control of the casting procedure is vital for final product quality, i.e. nice surface properties, absence of cracks and pores and a homogenous analysis throughout the finished slab. Correct temperature and absence of air while tapping the steel into the casting equipment are important factors. The presence of alloys in the steel affects the solidifying temperature in such a way that there exists a solidifying temperature range rather than a fixed temperature. The temperature where the steel begins to solidify is called the liquidus and the temperature when it is a stable solid is denoted solidus. This leads to a phenomenon called segregation where the recently solidified steel does not have the same analysis as the molten steel next to it due to decreased solubility in the solid state for some elements. The segregated elements become enriched in the interior.

The ladle received from secondary steelmaking is placed above a container called tundish which serves as a steel buffer between the ladle and the mould, ensuring a controlled flow and the ability to change ladle while casting. The mould is placed underneath the tundish, see figure 13. The whole process also involves a manoeuvre where the vertically orientated solidifying steel strand is transferred to a horizontal positioning before cutting occurs.

The liquid steel flows through a refractory pipe in the bottom of the ladle into the tundish. The top surface of the tundish is covered to protect from air and there may also be internal walls present in the tundish. Their purpose is to reduce the length any remaining inclusion must travel to be captured in the casting powder holding the slag phase – thus more inclusions will be removed and steel quality improved. However, such an arrangement is not present at SSAB Oxelösund. When the tundish is full the steel starts to pour down into the mould through another pipe. The mould is water cooled to promote solidification and the casting powder added to the top of the mould surface keeps the surrounding air away. The outer part of the steel begins to solidify as the temperature decreases. An oscillation movement of the mould promotes improved surface properties and prevents the strand to stick at the mould wall. The process parameters are controlled in such a way that the solid shell is thick enough to withstand the ferrostatic pressure (the weight of the liquid steel inside the strand) when the strand leaves the mould and enters the secondary cooling zone where water jet nozzles produce a water mist that cools the strand. Samples are taken from casting sequences representing T-sorts known as difficult to meet desired quality, and analyzed with respect to the inner structure and composition. When the strand reaches the end of the casting machine it is eventually cut into desired lengths, called slabs. Some slabs are visually inspected for surface cracks.

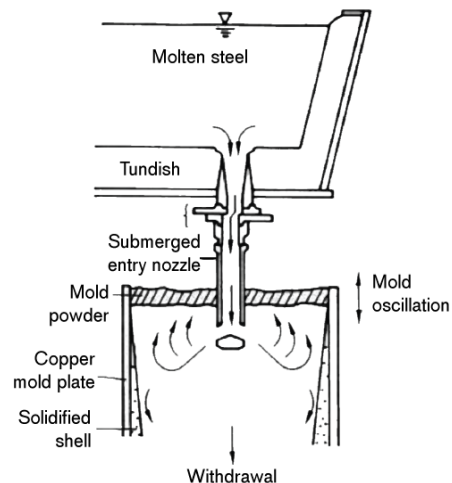

Figure 13. Illustration of tundish and oscillating mould. (Ullmans 2007)

After-treatment depends on the customer's demands but may imply grinding or storage in a diffusion furnace before they are taken to the rolling mill. However, many slabs may be directly delivered to customer.

Important parameters

It is especially the temperature that is important during the casting process. The temperature in the mould should be about 20–25 °C above the liquidus temperature to cover for heat losses, but the most important aspect is to minimize variations. Frequency and amplitude of the mould oscillations, cooling water flow, casting speed and steel levels in tundish and mould are other important control factors. A technique called soft reduction is used to minimize the appearance of segregations in the slab centre. The rolls at the end of the casting machine, placed just before the strand's inner melt solidifies, exert a pressure on the strand which homogenizes the metal composition.

2.2.8. Challenges in the production line

Several of the process steps may be denoted as crucial to reach the desired quality of the steel slabs. The blast furnace needs to deliver crude iron at a reasonably similar composition all the time. High levels of liquid iron inside the shaft will push up the hot blast raceway, causing excessive heating which may burn too much coke and increase refractory lin-

ing wear. Operational variations may cause extra amounts of desulphurization reagent to be used in the torpedo cars and also extra alloying in the steel plant, which is an economical drawback. The large volume of material passing the blast furnace and the long residence time makes every reduction in raw material use valuable both economically and environmentally.

In the steelworks, the process in the LD–LBE-converter is of high importance. Decreasing time from tap to tap, avoid slopping, reach the analyze targets and avoid slag carryover during tapping are things that the operation personnel must consider. Careful alloying of the crude steel at tapping from the LD-converter is necessary not to reach compositions higher than tolerated in the T-sort to be produced. The secondary steelmaking will fine-tune the composition, but the closer to final analysis the steel is already after tapping from the LD-converter, the smoother the process will continue. Deoxidation, degassing and homogenisation are also important steps for most T-sorts. An incomplete homogenisation due to insufficient gas bubbling may cause deoxidation agent and inclusions to remain in the steel. In addition to analysis, the crude steel temperature also needs to be accurate enough when the ladle is sent to casting.

During casting the temperature in the tundish is of great importance to avoid segregation and achieve good surface quality. If the soft reduction is to work properly there is a need to know where in the strand direction the last molten iron solidifies.

2.3. Previous studies of steelworks using multivariate methods

Multivariate methods have been used successfully in a wide variety of applications in the process industry for at least 20 years. Not least have several projects aiming for development of statistical process control been carried out (e.g. Nomikos & MacGregor 1995). The steel industry has also investigated some process parts with multivariate methods, but it may not always be publicly available.

Prediction of slips in the blast furnace has been attempted by Gamero et al (2006) and the development of an expert system for operating the blast furnaces at Corus' sites in the UK is described by Warren & Harvey 2001. In a study by Bhattacharya (2005) the silicon content in the hot metal produced in the blast furnace was predicted by a PLS model, however with great uncertainty in the predications.

A comprehensive study on process control has been carried out with SSAB Oxelösund as one of the primary research objects. The project was called HIPCON, Holistic integrated process control, and was supervised by IVL Swedish Environmental Research Institute⁴. One application developed within HIPCON is a desulphurization reagent dosage model where the desulphurization step in the torpedo cars was studied with multivariate methods. A model for reagent dosage calculation based on PLS was developed in 2004. A somewhat similar study has been done at Dofasco's steelwork in Canada, described by Dudzic & Quinn (2002).

Another objective for the HIPCON project was to classify LD-converter heats with respect to slopping occurring or not. The results were though not clear enough for certain predictions, but valuable information about factors affecting slopping behaviour was achieved. The work was presented in 2005. In a diploma thesis from 1996, Kappel investigates important factors for temperature decrease after blowing in the LD-converter with PCA and PLS models but bad quality of data deteriorates the result.

⁴ The HIPCON project was performed within the European Union's sixth framework programme for research and technological development 2004 – 2006.

Secondary steelmaking has not been investigated with PCA or PLS in particular, but a work done by Fernandez et al used Self-organizing maps (SOM) to predict steel quality after ladle treatment.

A comprehensive project developing an online monitoring system for the continuous casting stage has been developed at Dofasco's facilities in Canada (Zhang & Dudzic 2006). The system is able to monitor the whole batch duration; start-up, normal operation and transition phases such as spare part changes. To correct for the different numbers of observations between the occasions studied an indicator variable is used.

3. Data treatment and modelling

3.1. Data pretreatment

3.1.1. Data extraction and structure

Historical process data were extracted from databases at SSAB Oxelösund and supplied as Excel files which then were treated further with Microsoft Excel 2003. Availability of blast furnace historical data limited the time period to about six months, from mid August 2007 to mid February 2008, except for crude iron analysis data which were available from January 2006. Data extraction for all steps except the blast furnace was quick and data treatment and modelling first performed for these processes. Blast furnace data were extracted in steps, with the complete set available in April 2007.

Each of the Excel files contained data representing only a part of the actual block, such as desulphurization, crude steel analysis after LD-treatment, ladle furnace treatment, casting machine properties and remarks on the slab inner quality. Each of the tables contained one or more key variables useful to match the observations. The heat number in the LD-converter (named LSNR) was chosen as observation id, and the relevant heats for the three T-sorts chosen (T1, T2, T3) were selected within the specific period of time. Figure 14 describes the relationships between the different keys used to match data. It should be noted that the most challenging part is the fact that the crude iron used for a heat in the LD-converter may originate from both blast furnaces and several torpedos.

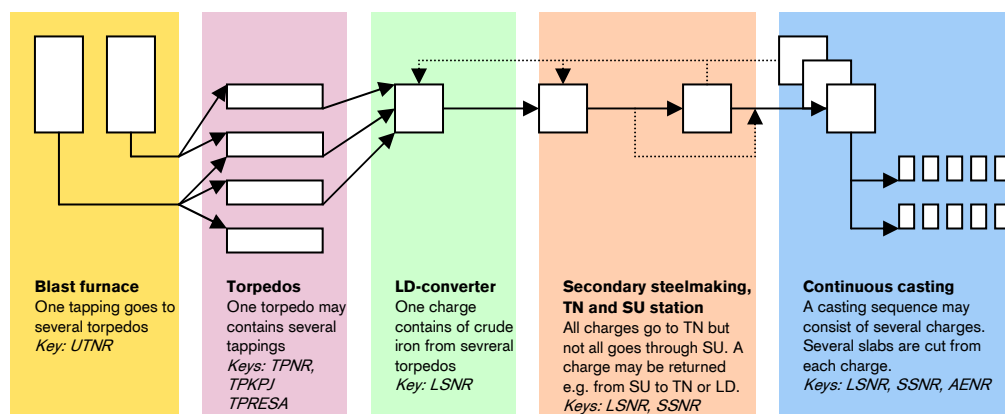

Figure 14. Schematic drawing of treatment pathways and key variables for each step.

Common variable types are analyses for metal and slag, amount of raw material added and operational parameters such as temperatures, gas flows and more. Several different resolutions are available:

- Time-based
 - Raw material additions from end of November were available on an hourly basis. They were matched with discharge data based on a blast furnace residence time of 7–8 hours: $0.04 \times 6 \text{ h ago} + 0.46 \times 7 \text{ h ago} + 0.46 \times 8 \text{ h ago} + 0.04 \times 9 \text{ h ago}$.

- Operational parameter data for the blast furnace were available as a 24 hour average which was matched to its corresponding discharge.
- Working shift-based
 - Raw material additions from end of August were available per working shift. Several discharges are made per working shift and data was matched by letting the first tapping for the shift have material data from previous shift, the second tapping took material data as half of the previous shifts additions plus half of the current shift. A third tapping took all its material additions data from the current shift.
- Heat-based
 - All data from LD-treatment and secondary steelmaking and casting data except slab analysis.
- Slab-based
 - Analysis of composition and quality for the slabs casted from a specific heat and sequence. For quality remarks the fraction of faulty slabs was calculated and used when weighting the data to represent LD-heat. For composition analysis the maximum and minimum values and standard deviation within each heat were used as variables.

In order to match data for torpedos with data for LD-treatment a coupling table was constructed and supplied by SSAB Oxelösund. It consisted of actual mass of the crude iron taken from a specific torpedo and used for a LD-heat and together with the total weight loaded the fraction from each torpedo could be calculated.

For blast furnace modelling, datasets using discharge number as observation id (rather than heat number) were used in addition to the ordinary LSNR-weighted data set. That made it possible to study the behavior of the actual process without losing important information. Some graphs visualizing analysis deviations were created using Microsoft Excel.

3.1.2. Variable selection

Some of the variables available were not useful for modelling in their original state, and therefore different approaches were used in order to create useful information from them. Examples of data treatment:

- Filtering data to get only observations corresponding to the time period and T-sorts chosen.
- Deleting unnecessary variables.
- Determining whether to use a parameter as variable and/or label.
- Creating a new variable from one or more existing ones, for example:
 - *Treatment time* calculated from *stop* and *start timestamp*.
 - *Total amount alloy added* calculated from *alloy number in nth addition* and *weight added in nth addition*.
 - *Amount of gas added* calculated from *gas flow* and *time*.
 - *Lance height after nn% of the treatment* calculated from *lance position before change* related to *fraction of treatment time when change occurred*.
 - *Deviation from target* created from *measured value* and *aim/max/min value*.
 - Relative variables, e.g. *amount of reagent per amount of sulphur*.

For some of the data processing tasks Excel macros were created using Microsoft Visual Basic. The accuracy of the data tables created by these macros was verified by random sample comparison with original data.

3.1.3. Block construction

The process naturally decomposes into five blocks as described in section 2.2.1. Data tables for each block were merged using Microsoft Access 2003 and typical variables can be seen in figure 15. The two letter abbreviations will be used when referring to the different blocks later on.

SUPER LEVEL MODEL				
BF, blast furnace	TP, torpedo cars	LD, LD-converter	SS, secondary steelmaking	CC, continuous casting
Material data - ore pellets - coke - briquettes - inject-coal - limestone Analyses - crude iron - slag Parameters - air blast - temperature - pressure	Analyses - before deS - after deS - deviation Additions - CaC ₂ Parameters - reagent flow - metal weight - temperature	Analyses - crude iron - after conv. Additions - slag formers - alloys - scrap Parameters - lance pos. - oxygen flow - gas bubbling - conv. time	Both TN and SU Additions - alloys - deO agent Parameters - gas bubbling - stirring - heating - vacuum Analyses - steel - tundish	Parameters - oscillations - temperatures - H-diffusion Slab analyses - inner quality - surface qual. - composition
Crude iron variations	Desulphurisation	Slopping Analysis misses	Analysis and temp misses	Slab quality

Figure 15. Illustration of the multiblock model with the different variable types noted.

Each data block contained the same observations; for the last four blocks there were 477 observations ($N_{tot} = 477$) and for the BF block $N_{BF} = 386$, due to missing data, especially for August. The Excel files for each block were imported one by one into the modelling software. The number of variables in each block, K , were 58 for BF, 37 for TP, 105 for LD, 153 for SS and 148 for CC, i.e. $K_{tot} = 501$. The three T-sorts used in the study constitute subsets of observations as follows: $N_{534} = 181$, $N_{723} = 96$, $N_{763} = 200$. A complete list of variables used, together with a short description, is found in Appendix B: Variable list.

3.2. Modelling

Modelling has been carried out using the software Simca-P+ 11.5 from Umetrics AB, Umeå, Sweden. At first, the individual blocks were modelled separately with PCA to identify patterns and variables influencing the quality targets within the particular step. Another important task is to investigate which phenomena that are captured in the principal components in order to interpret the models and especially understand contributions to the hierarchical model. In addition, for some blocks PLS models were created to study particular relationships. Below methods and arguments are presented quite general, only mentioning details to a small extent. All modelling have been documented separately in Simca-P+ project files and spreadsheet documents.

3.2.1. Block modelling

After importing the whole data table to Simca-P+, a workset is created before a model is fit. When analysing and improving the model it is then possible to create new worksets

based on the original data or an existing model. By default a variable or observation with more than 50% missing values will be excluded from the workset, but for some models the limit was set even higher in order to model information that were seldom registered, e.g. slag analysis after LD-treatment.

When fitting the model, Simca-P+'s autofit-function has been used most of the times. It calculates the number of components that are cross-validated according to a set of rules (Umetrics 2002):

1. Component significant if $Q^2 > b$ where b is 0 for PLS, whereas in PCA it increases with the number of components calculated, to account for loss in degrees of freedom.
2. Component significant if $Q_{var}^2 > b$ for at least \sqrt{K} variables (or at least one variable for PLS). Q_{var}^2 is the explained variance for a variable.
3. Only applicable to PCA. A non-significant component according to (1) and (2) may be denoted significant if the next component is significant and they have similar eigenvalues (max 5% difference).

By looking at the R^2 and Q^2 values for the model and the contributing variables, a brief understanding of the data's capability of describing the process is achieved. For real processes the level of explained variance is normally rather not very high, especially if the data resolution is low and the process is complex. Sometimes data quality may be a reason to bad statistical properties. In most cases, the workset has been carefully examined for outliers, e.g. obviously false analysis values, by variable trimming where values below or above a certain limit are excluded. This method should however be used with care, not to remove useful information.

Two-dimensional plots of the first two score and loading vectors respectively have been used to reveal the most dominant factors in the data set. This is not always the phenomena of interest, which may be captured in later components as well. For the steelworks blocks, when all T-sorts are included in the model the first score-plot typically shows the T-sort grouping due to differences in treatment and analysis. Therefore models have been made both for the whole set of observations but also for each subset of T-sort specific observations.

When considering a components importance it's fraction of explained variance have been considered. Simca-P+ automatically calculates and shows the Hotellings T^2 ellipsoid which simplifies outlier detection. It is however important to investigate the reason for an observation being located outside the T^2 -range. For example, when modelling data from secondary steelmaking, observations may not always have the same treatment path, though belonging to the same T-sort. This will show up in the score plot, sometimes creating outliers. In these cases, the observations have been kept in the workset. Other more obvious outliers have been removed, e.g. lance height registered as zero.

The $DModX$ -plot have been used in a similar way as the score-plot. It is possible to find other types of outliers that are not outside the T^2 -plot but still deviate from the model. However, it is still important to check the cause for the observations high $DModX$ -value.

Relationships between variables have been studied using the loadings where correlations can be detected. Both two-dimensional scatter plots and column plots have been used. To see what factors that influence a specific phenomenon, such as insufficient sulphur removal, the *contribution plot* is a useful tool. By selecting objects that share the phenomenon of interest in a score-plot of relevant components it is possible to create a column plot of each

variables contribution to the selected observations compared to the whole set of observations, where the loadings of respective components are used as weights.

Labels and colours that identify patterns and characteristics of the observations have been used as helpful tools in model analysis, as well as object selection to visualize only observations of interest. Table 1 summarizes the most important models created for each block.

Block	Model no	<i>N</i>	<i>K</i>	<i>A</i>	<i>R</i> ²	<i>Q</i> ²	Comment
BF	BF03.M4	577	56	8	0.73	0.54	PCA, BF2
	BF03.M7	371	51	8	0.79	0.58	PCA, BF2, 2007
	BF04shift.M11	889	17 (X), 18 (Y)	6	0.83 (X), 0.38 (Y)	0.37	PLS, steel and slag as Y
	BF04shift.M14	989	55 (X), 5 (Y)	2	0.45 (X), 0.01 (Y)	0.001	PLS-DA for working shift
TP	TP02.M4	458	31	6	0.71	0.38	PCA
	TP03.M11	279	21 (X), 3 (Y)	4	0.52 (X), 0.40 (Y)	0.26	PLS, S as Y
LD	LD05.M7	477	74	7	0.68	0.50	PCA, incl. aim values
	LD05.M8	477	53	9	0.66	0.29	PCA
	LDSSCC.M7	477	102	8	0.43	0.21	Analysis outliers removed
	LDslp.M1	439	74 (X), 1 (Y)	2	0.32 (X), 0.11 (Y)	0.13	PLS, slopping as Y
SS	SS01.M1	477	192	3	0.38	0.34	PCA
	LDSSCC.M16	477	124	4	0.53	0.50	PCA
	TPLDSSCC.M21	477	115	5	0.61	0.55	PCA
	TPLDSSCC.M22	211	115	4	0.55	0.47	PCA, only SU-heats
	TPLDSSCC.M24	452	35 (X), 1 (Y)	2	0.34 (X), 0.52 (Y)	0.47	PLS, TN temp. diff. as Y
CC	CC03.M7	472	205	6	0.48	0.38	PCA
	LDSSCC.M18	475	134	5	0.54	0.47	PCA
	LDSSCC.M30	469	126 (X), 5 (Y)	3	0.50 (X), 0.16 (Y)	0.12	PLS, slab quality as Y

Table 1. Summary of properties for the most important block models created. Model names refer to the project files.

The blast furnace models have discharge number as observation id while the other blocks use LD-heat number as unique identification.

3.2.2. Hierarchical modelling

When preparing to build a hierarchical model for the whole process the block models were chosen as base models in Simca-P+. This enabled the score vectors of each model to be selected as variables when creating the workset for a new model. The fraction of explained variance for a specific component has been an important factor when selecting components to include in the model. Several combinations were tried out but it is normally the first few score vectors in a model that reveals the important information which is possible to use in a super-level model.

Four models were made, one containing all three T-sorts and then one for each T-sort. Table 2 summarizes the hierarchical models.

T-sort	<i>N</i>	<i>K</i>	<i>A</i>	<i>R</i> ²	<i>Q</i> ²	Comment
All	477	15	2	0.37	0.07	First component insignificant
T1	181	10	2	0.36	-0.06	First component insignificant
T2	93	10	2	0.50	0.12	Two significant components
T3	200	13	2	0.34	-0.07	No significant components

Table 2. Summary of properties for the hierarchical models created.

4. Results

4.1. Block modelling

4.1.1. Blast furnace (BF)

Graphs created to visualize production variations in crude iron composition for important elements show that silicon and sulphur deviations from aim values are frequent – every third discharge contains to high silicon and/or sulphur concentration. Too low manganese content is also common while vanadium, chromium and phosphorous exceeding are below five percent of the taps. In total, 56% of the crude iron discharges do deviate from the analysis target interval for one or more elements.

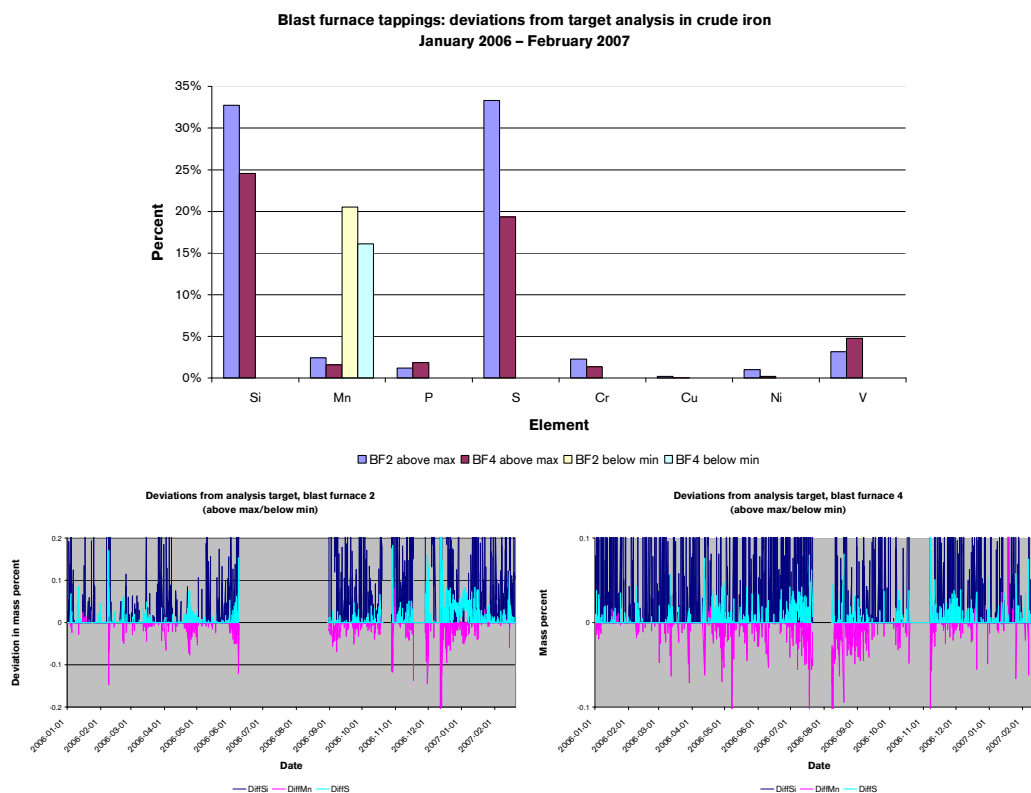

Figure 16. Blast furnace crude iron composition target deviations (above max/below min). Above: Accumulated, below left: time-resolved for BF2, below right: time-resolved for BF4. Positive value axes are cropped for the two lower graphs.

These deviations are more frequent under certain times of operation. When examining model BF03.M4 it is shown that periods of unstable operation in blast furnace 2 are manifested as outliers both in the score and distance-to-model plots. When comparing the observations from one such period (in November–December) with the average the main contributors are high silicon content, low manganese oxide content and low top gas flow. A similar analysis for blast furnace 4 shows fewer and shorter periods of unstable operation, and the contributors are higher silicon and titanium content in crude iron and higher sul-

phur content in slag. The time periods can be seen in the distance-to-model plot in figure 17.

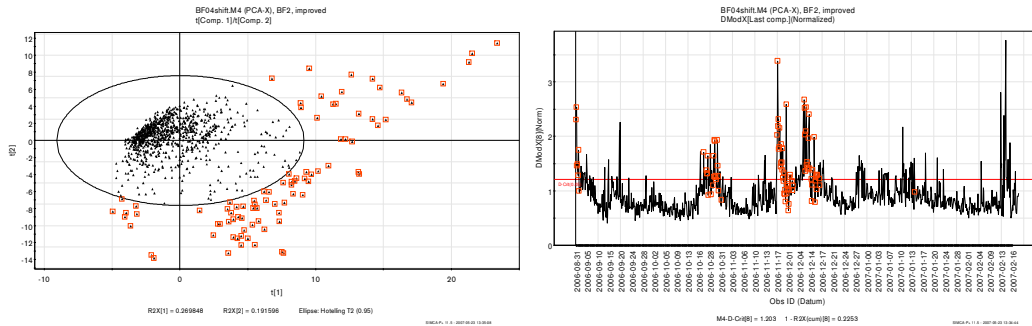

Figure 17. Unstable operation in blast furnace 2. The red squares represent the same observations in both plots. In the distance-to-model plot (to the right) the time periods can be seen: (a) during start-up in August 2006, (b) after shut-down in October, (c) unstable operation in November – December.

The models built in project BF03 also showed other results regarding factors influencing crude iron composition:

- By looking at the loadings for M7 it was seen that phosphorous is negatively correlated to sulphur content in crude iron.
- Sulphur content in the slag is positively connected to basicity and negatively to temperature in shaft and air blast flow, temperature, oxygen content and also top gas flow.

The PLS models in project BF04shift were used to predict metal and slag analyses based on material additions per working shift and operational parameters per day average which should be considered as poor data resolution. The model residuals are therefore very large for many response variables, but measures such as lime, dolomite and silicon oxide content in slag and phosphorous and chromium content in the metal have reasonably good prediction properties. Explained variance for the prediction sets are given for both furnaces in figure 18.

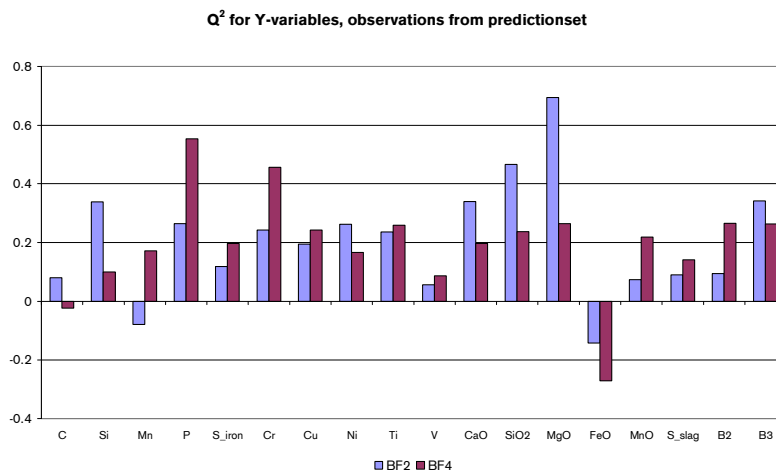

Figure 18. Explained variance for response variables (Q^2_{var}) – observations from prediction set.

Performing discriminant analysis on material data based on working shift does not imply that any differences exist between the working shifts. This is illustrated in figure 19.

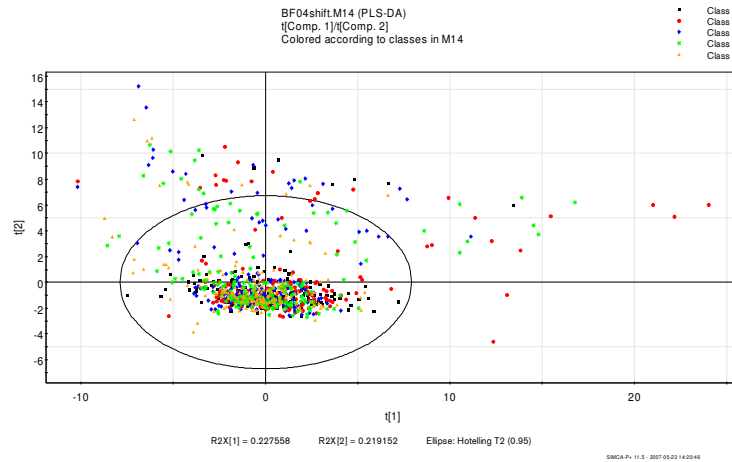

Figure 19. Score plot showing the discriminant analysis made for working shifts in the blast furnace. No regular pattern could be found.

4.1.2. Desulphurization (TP)

A score plot of the first two components in model TP02.M4 shows a clear time drift for the heat weighted observations. This is due to compositional variations in the crude iron received from the blast furnace – observations from August and September have higher phosphorous and lower manganese and chromium content than the average observation. The opposite is true for observations from January and February compared to average. Plotting the incoming compositions for P, Mn and Cr shows an overall increasing time-trend for Mn and Cr and a decreasing time-trend for P.

Plotting contributions to scores for observations with high residual sulphur content (remaining sulphur after main injection of calcium carbide – ordered content > 0) does not give any easily interpretable results. Notable is that the incoming sulphur content does not affect the ability to reach target concentration. The explained variance for sulphur content (TAS2) has been low in the PCA models created. For TP02.M4 $R^2_{TAS2} = 0.71$ and $Q^2_{TAS2} = -0.14$. However, introduction of a variable for the absolute sulphur amount (SABS_E) improves the model and Q^2_{TAS2} is then calculated to 0.33 (TP03.M2).

A PLS model was fitted in order to reveal important factors for desulphurization (TP03.M11). The response variables were *sulphur concentration after treatment*, *absolute amount after treatment* and *deviation from ordered sulphur content*. Looking at the coefficient plot shows that most variables are not significant. The contributions (significant variables only) are as follows ('+' indicates positive correlation; '-' indicates negative correlation).

- Sulphur concentration and absolute S amount after treatment
 - ordered sulphur content
 - hot metal weight
- Deviation from ordered sulphur content
 - chromium content
 - carbon content
 - ordered sulphur content

This PLS model had much better statistical properties for TAS2 than the PCA models developed. $R_{TAS2}^2 = 0.54$ and $Q_{TAS2}^2 = 0.40$.

4.1.3. LD-LBE converter (LD)

Studying model LD05.M1 shows that the variables describing scrap additions does not contribute much to the model. This may be caused by the many different scrap numbers used in the dataset, i.e. each number is not used enough times to bring meaningful information into the model.

When trying to find reasons for missed analysis after LD-treatment, it can first be established that the incoming crude iron composition may contribute. In the left part of figure 20 the loadings p_3 and p_4 for LD05.M7 can be seen. Variables for incoming crude iron analysis are represented by black dots and it can be seen that they are affecting both t_3 and t_4 . The score plot to the right implies that the reason for the heat in the upper left corner being an analysis miss may be due to high levels of molybdenum, chromium, manganese or nickel (or low levels of variables in the opposite direction). In this case, the steel analysis after LD-treatment showed high nickel level.

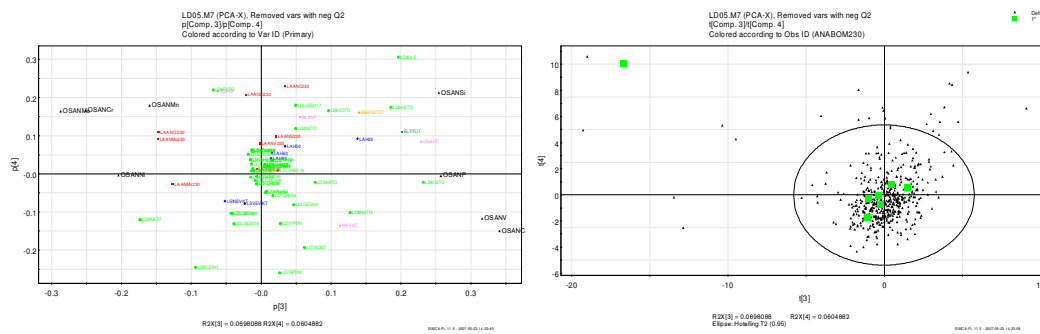

Figure 20. Loadings and scores for LD05.M7. Crude iron composition variables are seen as black dots and labels in the left plot. Observation deviations from target analysis are shown in green in the right plot.

There are also six other analysis misses; one heat is too high in carbon, nitrogen and sulphur and another too high in manganese and too low in nitrogen. Four heats are too high in phosphorous. These observations are found in the middle of the score plot, with only small dependencies on incoming crude iron composition. A plot for the four high P heats shows the following contributions:

- High incoming phosphorous content, low silicon and titanium.
- Low amount of lime and oxygen added, very low estimated slag amount.
- Short blowing time.

The result confirms that low silicon content only allows a small amount of slag formers to be added since the desired basicity otherwise would be exceeded. As phosphorous cleaning is an important task for the slag, the LD-treatment is not able to meet desired P level.

Analysing model LDSSCC.M7 and plotting the score's t_2 and t_3 for only the observations where severe slopping has been registered, a slightly skew representation toward the lower right corner can be seen (figure 21). When studying the loading plot for the same components and the contribution plot for the whole group of slopped heats compared to the average, it can be seen that variables describing estimated amount of slag, total treatment time, blowing time, additions of lime, dolomite and oxygen are partly responsible for this skew-

ness. A slopped heat will naturally demand longer treatment time since the decarburization rate needs to be decreased to control the process. The slag formers may be due to high silicon content. Slopping prediction gives a result comparable to the one achieved in the HIP-CON project.

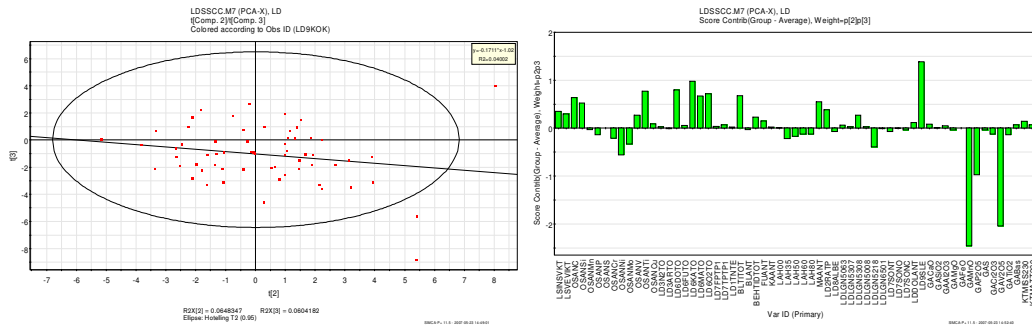

Figure 21. Score plot (t_2 and t_3 , left) and contribution plot (right) for heats registered with severe slopping.

4.1.4. Secondary steelmaking (SS)

A quick first model (SS01.M1) shows that the T-sort's are clearly visible also in the secondary steelmaking. This is quite obvious since the quality targets and treatment paths are well established for each T-sort. For example, T-sort T3 and T2 are seldom treated in the ladle furnace while T1 almost always are. That is captured in the first two model components. Plotting scores t_3 against t_4 shows distinct observation groupings – not only caused by T-sorts but also sub-groupings due to alloys added (figure 22).

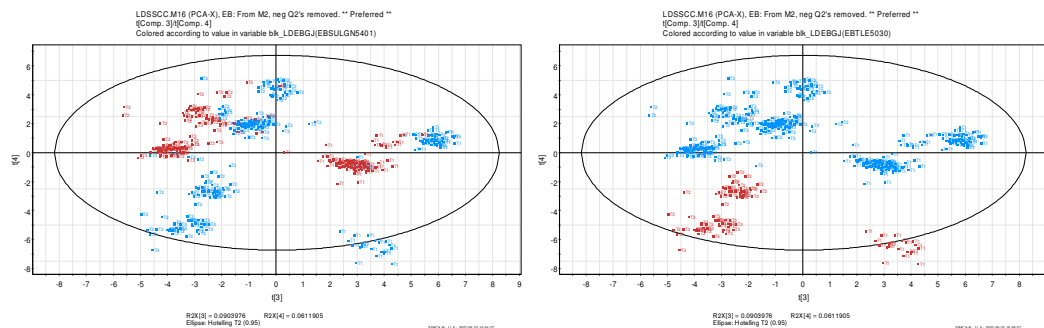

Figure 22. Left: Coloured according to if SU alloy 5401 (CaSi wire) has been added (brown observations). All three T-sorts have observations that used more or less of this alloy. Right: Coloured according to if TN alloy 5030 (FeV) was added (brown observations). All three T-sorts have groups of observations that used this alloy.

Remaining three groups of observations are mainly due to the TN-alloy 5035 which is FeNb. It should be noted that other alloys also contribute to the observation groupings.

Examining model LDSSCC.M16 by plotting scores t_1 and t_3 and loadings p_1 and p_3 (figure 23) shows that almost all heats with negative deviations from aim temperature at TN are sent to SU for heating. It is also shown that T-sort T2 and T3 are similar to each other (with respect to Ti, Si, V, C, Mo, Al and P) but dissimilar to T1.

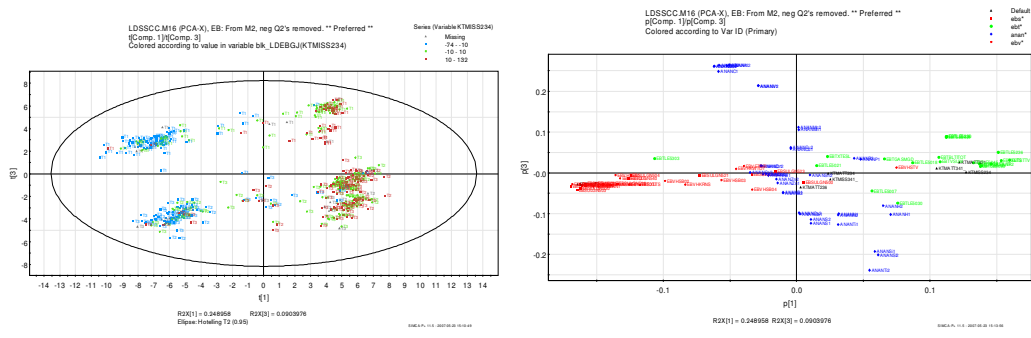

Figure 23. Temperature deviations for secondary steelmaking. Left: Score plot coloured according to each observation's deviation from aim temperature. Blue ones are more than 10°C below and brown ones more than 10°C above target. Right: Loading plot coloured according to variable type. Green variables belong to TN station, red variables belong to SU station, blue variables represent steel analysis and black variables represent temperature measures.

Using model TPLDSSCC.M24 to model causes for temperature deviations at TN it can be seen (figure 24) that factors connected to positive deviations are e.g. alloy 5499 (scrap additions for cooling) and heat weight. Additions of alloy 5303 (aluminium wire) and synthetic slag are related to negative deviations from aim temperature.

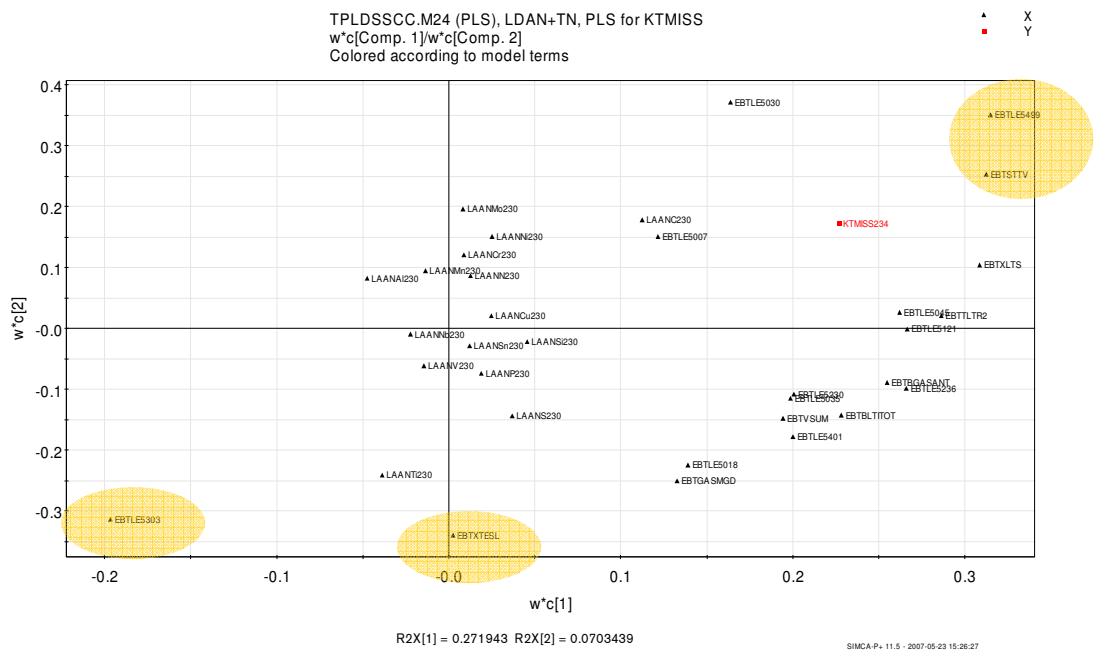

Figure 24. Loading weights plot for temperature deviations at TN.

In model TPLDSSCC.M22 reasons for temperature deviations at SU or casting were investigated but no obvious reasons could be found.

4.1.5. Continuous casting (CC)

The difference in analysis between the T-sorts is evident in this last process step, as can be seen in figure 25. The score plot for model CC03.M7 shows distinct groupings, mainly due to differences in final tundish analysis but also other factors such as casting settings.

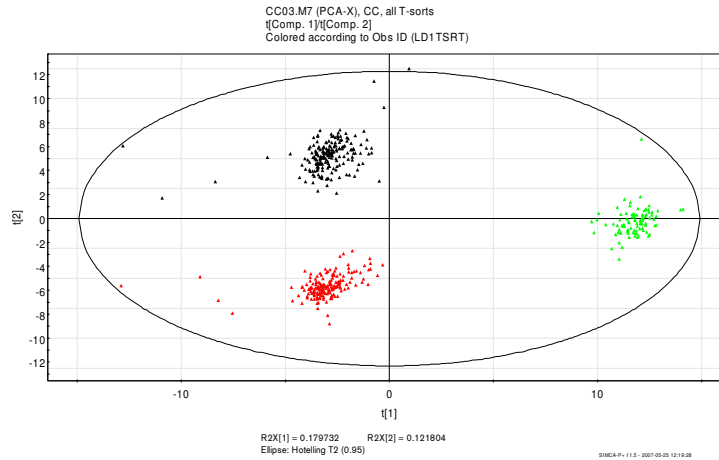

Figure 25. T-sort groupings in the continuous casting block.

To avoid correlations caused by T-sort differences, one model for each T-sort was created, but the statistical properties became very poor due to the lack of variation in data. Therefore the three T-sorts were modelled together – which is necessary to keep in mind when analyzing the results. Table 3 shows estimated relations between the T-sorts for different properties, based on score contributions between the groups.

Property	Less/lower	More/higher
Temperature	T1	T2 T3
Casting weight	T1	T2 T3
Mould oscillations	T1 T3	T2
Mould engine current	T2	T1 T3
Mould width	T1	T3 T2
Mould piston stroke (true value)	T2	T1 T3
Slab inner faults	T1	T3 (centre quality) T2 (firm side) T2 (centre quality) T3 (firm side)
Slab visual faults	T1	T3 T2

Table 3. Estimated differences between T-sorts at casting.

When trying to capture reasons for quality problems loadings for the model LDSSCC.M18 were analyzed. Positive correlation exists between fraction of slabs with visual faults and casting data such as piston stroke, mould oscillations, sculls and number of heats in tundish. Internal quality problems are correlated to tundish temperatures and slab analyses. Further modelling was performed to get more information about causes for quality problems. A PLS-model where slab analysis data were replaced by analysis data from tundish (LDSSCC.M30) was analyzed. Results are presented for visual slab quality and segregations – statistical properties for halfway crack at firm side were too poor for reliable interpretation to be done.

- Fraction of slabs with remarks on visual quality (data table AMNVFEL)
 - + Positive correlation: tundish analysis for Si, Ti and N, casting weight, true mould thickness, oscillations, common length of mixed zone and maximum slab width.
 - Negative correlation: tundish analysis for C, Mo, V and Al, mould piston stroke.

- Slab centre quality remarks (variable PRCENBET)
 - + Positive correlation: tundish analysis for Si, Ti and N, casting weight, true mould thickness, tundish temperatures, oscillations and maximum slab width.
 - Negative correlation: tundish analysis for C, Mo, V and Al, mould piston stroke.

- V- segregation width (variable PRBKVSEG)
 - + Positive correlation: common length of mixed zone,
 - Negative correlation: casting weight, total casting time, number of heats in tundish, tundish temperatures.

The fact that there are observations belonging to different T-sorts in the model is clearly an aggravation. As can be seen in table 3, many of the factors influencing the quality variables also vary between T-sorts which make interpretation hard. The main conclusion is therefore that visual quality is connected to casting parameters such as oscillations and inner quality to tundish temperature and steel analysis.

4.2. Hierarchical modelling

The hierarchical model containing all observations models the differences between the T-sorts (figure 26), though the statistical properties are poor as stated in table 1 on page 31. The result may be summarized as follows:

- Blast furnace and desulphurization data does not contribute to T-sort differences (i.e. there are no T-sort specifications in these blocks, except for S content).
- LD-treatment differs mainly in alloys and scrap added.
- Analysis differences between T1 and T2 are e.g. Cr, Nb, B, Si and N.
- Analysis differences between T1 and T3 are e.g. C, Mo, V, Al and Ti.
- Analysis differences between T2 and T3 are e.g. Cr, Nb, B, Ca, Mn, V and N.
- The ladle furnace is mainly used for T1.
- Casting block differs in analysis, temperature and casting parameters such as mould oscillations and engine current.

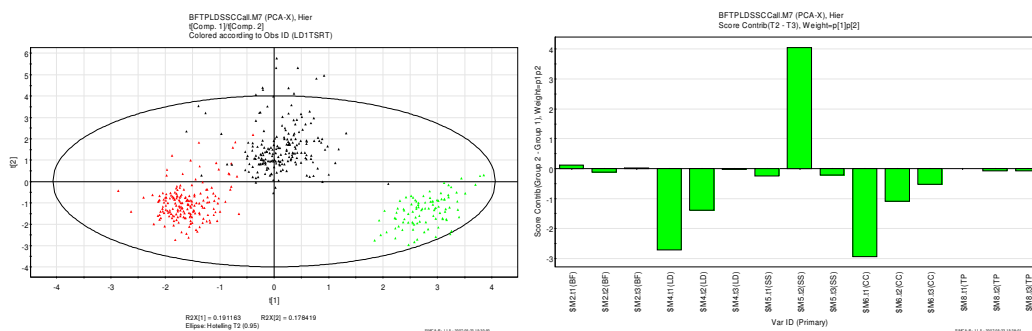

Figure 26. Above: Score plot for the hierarchical model with all T-sorts. Coloured as T1 red, T2 green, T3 black. Below: Block contributions to the difference between T2 and T3 – only steelworks variables contribute.

A significant model could be auto-fitted only for one of the T-sort sets. This implies that the connection between the blocks is rather small. For T-sort T2 a two component model was created although. Results from that model are presented in the following subsections.

4.2.1. Slopping

Observations registered as severe slopping heats during LD-treatment were marked as red dots in the score plot and it was obvious that they tend to be in the left part of the model half-plane (see figure 27). The loadings show that t_2 from BF block contribute positively and t_1 from TP block contribute negatively. The largest loading for both of these two blocks is the titanium content in crude iron, but as can be seen in the lower part of the figure, variables such as crude iron temperature (positive correlation) and sulphur content (negative correlation) also contribute.

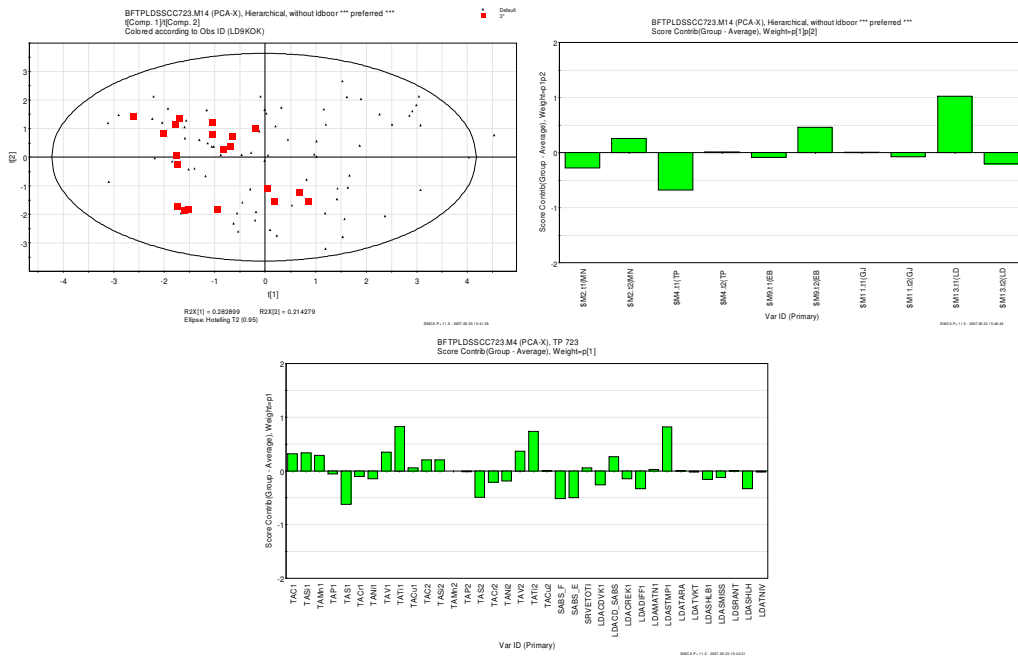

Figure 27. Upper left: Score plot showing the objects registered with severe slopping as red dots. Upper right: contributing variables to the red objects from the TP block. Below: Contributing variables from the TP block to objects registered with severe slopping.

4.2.2. Analysis misses

It has not been possible to find any relations between the blocks for the analysis misses. Results within the SS block are available in section 0.

4.2.3. Temperature misses

The score plot of t_1 and t_2 do capture information about temperature misses. The heats exceeding aim temperature at TN station with more than 30°C can be found in the upper half of the model plane, and vice versa.

A contribution plot comparing objects 30°C below aim with objects 30°C above aim shows the differences between the two groups, mainly from TP and SS block. The plots for contributing variables are seen in figure 28, and their interpretation is that:

- Low phosphorous and silicon content in the crude iron is related to negative temperature deviations.
- Large desulphurization seems to be connected to negative temperature deviations, i.e. positive contribution for S content before and negative contribution for S content after desulphurization.

- Large additions of reagent (CaC₂) and high level of hot metal in torpedo contributes to negative temperature deviations.
- The variables contributing from the SS block are mainly due to that heats below aim temperature are treated in the ladle furnace.

A natural explanation is that lower silicon in the crude iron gives smaller contribution of exothermal energy in the LD-treatment, while high sulphur content causes longer treatment times in the TP block which increases heat losses.

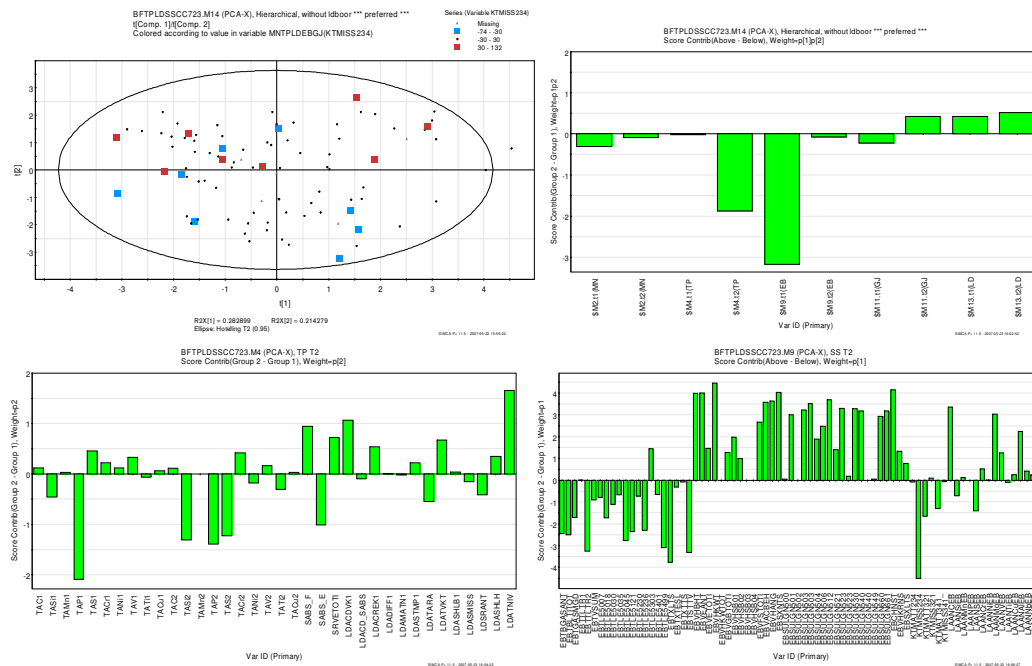

Figure 28. Contributing variables to differences between heats below and above target temperature at TN station. Upper left: Score plot in the hierarchical model. Blue dots are objects 30°C or more below aim temperature, brown dots objects 30°C or more above aim temperature. Upper right: Block contributions Lower left: TP block. Lower right: SS block.

4.2.4. Slab quality

It has not been possible to find any relations between the blocks regarding slab quality (see figure 29). Results within the CC block are available in section 4.1.5.

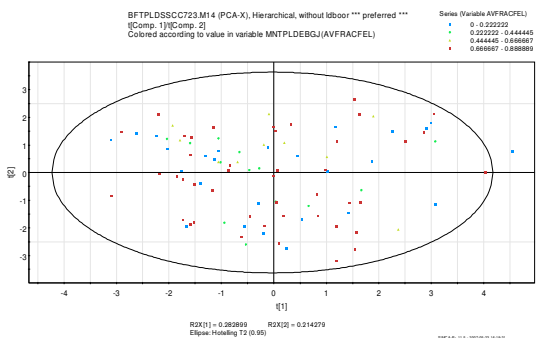

Figure 29. Objects coloured according to fraction of slabs with visual remarks are randomly distributed in the score plot, implying that no obvious connection to earlier blocks exist.

5. Discussion and conclusions

The results of the study show that multivariate statistical methods as principal component analysis and projection to latent structures works well for studying processes in steelmaking. The quality issues present in each step in the production have been explained in more or less detail within the scope of the project. Some of the results are already known at SSAB Oxelösund, which confirms their correctness.

Modelling has not always been straight-forward though. The many raw materials used, alloy added and treatments available create data sets with many different variables and it may sometimes be hard to grasp useful information. Data pre-treatment takes considerable amounts of time and about one third of the project time has been put on data organization.

5.1. Blast furnace modelling

More than one third of all blast furnace crude iron discharges are not satisfactory with respect to analysis targets (see page 32). The most common element that deviates from target is silicon, which in combination with other factors increases the slopping risk (figure 21) and also causes extra slag formers to be added to achieve desired basicity. However, the blast furnace is the process step which shows the most promising conditions for successful online modelling and statistical monitoring. It has been possible to predict some slag and crude iron properties from a dataset containing information about raw material additions and operational parameter data – and although the data resolution has been poor (working shift and day-average) the explained variance was reasonably good for some of the response variables.

In order to study it in more detail and develop statistical models for process control, time resolved data for operating parameters such as temperatures and pressures in shaft, blast properties, top gas flows, temperature, composition and more – together with raw material addition data – needs to be used for prediction of crude iron and slag analysis and crude iron temperature.

5.2. Desulphurization and LD-treatment

Desulphurization in the torpedo cars has been the least successful block to model in this study. The data available and the models developed have not been able to reveal additional ways of improving the process. The result in model TP03.M11 shows that high chromium content correlate positively with heats with high residual sulphur content, but it has not been seen how reliable this result is. In general, the degree of explained variance for variable TAS2 (sulphur content after desulphurization) has been rather sensitive to value trimming and introduction of similar variables such as absolute amount sulphur (SABS_E).

Analysis misses after LD-treatment are not very frequent for the observations included in this study. Especially the metals are commonly within the target range, while phosphorous deviations are more common. This is due to the fact that the increased temperature during LD-treatment decreases solubility of P in the slag. The slag's P cleaning effect is also dependant on slag amount and both Si and P content in incoming crude iron, see figure 20 on page 35.

The hierarchical model for T-sort T2 indicates that high titanium content plays a role for increased slopping risk. This is illustrated in figure 27 where it is also seen that there are

heats not registered with ‘severe slopping’ among the red ones. Several factors that increase the risk for slopping are known, but the way the process is handled may avoid slopping to occur. Common experience has not been able to explain why this correlation can be seen, but it may be that a third factor is the actual cause.

The models have not been able to capture the significance of different scrap quantities added in the LD-converter. To achieve better models, the variables describing scrap additions may be organized in other ways or one could use more observations. The alloys added directly after finished LD-treatment have been included in the LD block, but one could also make a specific alloying block, enabling detailed investigation of material additions.

5.3. Secondary steelmaking

In general the secondary steelmaking has been quite hard to model due to the many variables, e.g. alloy additions, gas bubbling, stirring, heating, vacuum treatment and steel analyses. The fact that heats may have different treatment paths also makes it difficult to model this block. An alternative approach could have been to make several blocks instead of just one, for example one for the TN station and one for the ladle furnace treatment. This approach was used with good results in the PLS-model TPLDSSCC.M24, which contained steel analysis values after LD-treatment together with variables from TN station to predict deviations from aim temperature.

A large portion of the heats have temperature deviations which will cause extra treatment time for heating in the ladle furnace. If a greater portion of the heats could maintain a temperature within the limits it would bring economical and environmental savings. The negative deviations have been explained to some extent in the hierarchical model (section 4.2.3, page 40), which said that low silicon content and high sulphur content are the main reasons. Low silicon content is not very common (see figure 16, page 32), but when it happens in combination with high sulphur content it may affect the secondary steelmaking. Better quality of the crude iron produced in the blast furnace is therefore one of the keys to more stable temperature control in the steelworks.

Another interesting fact is the spread within T-sorts depending on alloys added, see page 36. They mainly depend on additions of CaSi used for inclusion removal, and also FeV and FeNb which are used to reach specified analysis. The reason is that the alloying performed after LD-treatment and at TN station not always is able to adjust the steel analysis to the desired quality directly.

5.4. Continuous casting

Modelling the casting block has revealed that there are relations between operational parameters and external (visual) slab quality. The data analyzed in the present study is per heat which should be considered as a quite poor resolution since casting is performed continuously. It is also important to point out that the data variation present within one T-sort specification is not enough to get good model properties. If further modelling is performed on data with better resolution and preferably designed experiments where T-sort differences are eliminated, the casting machine’s influence on visual faults may be established in more detail.

In order to improve internal slab quality and minimize segregation problems during casting it is necessary to have careful control of tundish variables such as steel analysis and temperature. If monitoring and control of temperature and analyses can be improved further it would be of great importance.

5.5. Quantification

Since 56% of the crude iron discharges from the blast furnace do deviate from one or more analysis target intervals (section 4.1.1, page 32) there is plenty of room for improvements. The most common deviations which are silicon and sulphur will cause problems later in the process:

- High silicon level will demand large amounts of slag formers to be added in the LD-converter.
- Low silicon level together with high phosphorous level will increase the risk for too high P content which may be detrimental for the whole batch.
- High sulphur level will increase time for desulphurization and if, in addition, the silicon level is low it will be hard to reach desired temperature, i.e. extra heating in the ladle furnace will be needed.

If extra slag formers are added, it means about six tonnes of lime and dolomite extra per heat which means economical costs but also increased amount of slag which must be taken care of. A heat with too low temperature that is sent to the ladle furnace demands a large amount of extra energy – as a simple example, the energy required to increase the temperature of a steel batch with 30°C can be estimated to 2.5 GJ:

$$Q_{extra} = c_{p,steel} \cdot m_{batch} \cdot \Delta T = 420 \cdot 200000 \cdot 30 = 2.5 \text{ GJ}$$

If a cause behind the indication that titanium content correlates with increased slopping risk can be identified and routines developed to decrease the number of slopped heats it will also bring economical and environmental benefits. Each slopping incidence causes material losses, dust emissions and interrupted operation.

6. Proposals

With the results and discussion of this study as a starting point, the following proposals are made for the continued work:

- Continue with multivariate modelling of the blast furnaces using high resolution process data, and eventually online data for the development of an early warning system of analysis target deviations and prediction of iron and slag analysis.
- Investigate further if and why titanium content in crude iron does increase the risk for slopping to occur.
- Continue with modelling of the continuous casting block using high resolution data from the tundish and casting machine in order to develop a multivariate statistical process control model for slab quality improvement.

Acknowledgements

Thanks go to the Informatics department at IVL Swedish Environmental Research Institute and SSAB Oxelösund for the possibility to perform this diploma work. Especially I am thankful to my supervisors at IVL, Åsa Nilsson and Erik Furusjö, for support in methodology and evaluation throughout the project, and to my supervisor at SSAB Oxelösund, Mathias Thorén, for advice in metallurgical questions.

My examiner at Chalmers has been Bengt Andersson and big thanks go to him for his interested attitude and supportive manner.

References

- AISE – Association of Iron and Steel Engineers, *The making, shaping and treating of steel: Ironmaking volume*, 1999.
- AISE – Association of Iron and Steel Engineers, *The making, shaping and treating of steel: Steelmaking and refining volume*, 1998.
- Andersson M, Furusjö E, Jansson Å, *Production optimisation in the petrochemical industry by hierarchial modelling*, IVL report B-1586B 2004.
- Atkins P, Jones L, *Chemical principles*, 2nd ed., Freeman 2002.
- Bhattacharya T, *Prediction of silicon content in blast furnace hot meta lusing partial least squares (PLS)*, ISIJ International vol. 45 no. 12 (2005) 1943–1945.
- Bi X, *Modelling and analysis of the blast furnace process*, Department of Process Metallurgy, The Royal Institute of Technology, Stockholm 1989.
- Dudzic M, Quinn S, *Predictive modeling using adaptive PLS desulphurization reagent control system*, American control conference vol 1 (2002) 604–605.
- Jernkontoret, Jernkontorets utbildningspaket, 1996–2001.
- Fernandez A, Mendez L, Blanco J, Lopez A, *Application of techniques of dimension reduction to predict the steel quality at the end of the secondary steelmaking*, Industry applications conference vol 1(2005), 537–542,
- Gamero F, Colomer J, Meléndez J, Warren P, *Predicting aerodynamic instabilities in a blast furnace*, Engineering applications of artificial intelligence 19 (2006) 103–111.
- Geladi P, Kowalski B, *Partial least squares regression: A tutorial*, Analytical Chimica Acta 185 (1986) 1–17.
- HIPCON, *Holistic integrated process control*, www.hipcon.org. Performed within the European Union's sixth framework programme for research and technological development 2004 – 2006. Internal project reports are not publicly available.
- Martens H, Martens M, *Multivariate analysis of quality – an introduction*, Wiley 2001.
- Martens H, Naes T, *Multivariate calibration*, Wiley 1991.
- Montgomery D, *Design and analysis of experiments*, 5th ed., Wiley 2001.
- Nationalencyklopedin, Bra Böcker 1990–2007.
- Nomikos P, MacGregor J, *Multivariate SPC charts for monitoring batch processes*, Technometrics vol. 37 no. 1 1995.
- Qin J, Valle S, Piovoso M, *On unifying multiblock analysis with application to decentralized process monitoring*, Journal of Chemometrics vol. 15 (2001) 715–742.
- Renman L, *Multivariat dataanalys och kalibrering*, Göteborgs universitet 1998.
- Sethur F, *Austrian steel: Development and prospects*, The journal of industrial economics vol. 8 no. 3 (1960) 249–264.
- Smilde A, Westerhuis J, de Jong S, *A framework for sequential multiblock component methods*, Journal of Chemometrics vol. 17 (2003) 323–337.
- Steeluniversity.org, International Iron and Steel Institute, MATTER, The University of Liverpool 2002–2007.

- Ullman's Encyclopedia of Industrial Chemistry, 7th ed., Wiley 2006.
- Umetrics AB, Simca-P and Simca-P+ 10.0 User Guide and Tutorial, 2002.
- Warren P, Harvey S, *Development and implementation of a generic blast-furnace expert system*, Mineral processing and extractive metallurgy: IMM Transactions section C vol. 110 no.1 (2001) 43–49.
- Westerhuis J, Kourti T, MacGregor J, *Analysis of multiblock and hierarchical PCA and PLS models*, Journal of Chemometrics vol. 12 (1998) 301–321.
- Wold S, Esbensen K, Geladi P, *Principal component analysis – a tutorial*, Chemometrics and intelligent laboratory systems 2 (1987) 37–52.
- Wold S, Kettaneh N, Tjessem K, *Hierarchical multiblock PLS and PC models for easier model interpretation and as an alternative to variable selection*, Journal of Chemometrics vol. 10 (1996) 463–482.
- Zhang Y, Dudzic M, *Online monitoring of steel casting processes using multivariate statistical technologies: From continuous to transitional operations*, Journal of Process Control 16 (2006) 819–829.

Appendix A: Engelsk–svensk ordlista

Engelska	Svenska
Blast furnace	Masugn
Coke	Koks
Continuous casting	Stränggjutning
Ore	Malm
Shaft	Schakt
Slopping	Utkok
Ladle	Skänk
Ladle furnace	Skänkugn
Secondary steelmaking	Skänkmetallurgi
Tundish	Gjutlåda
Mold, mould	Kokill, gjutform
Slab	Stålämne

Appendix B: Variable list

Most of the variables mentioned here are named as in the databases. Others have been created for this study and are described in the study's data pretreatment documentation.

Primary observation identification

As primary observation id, LSNR has been used for TP, LD, SS and CC blocks as well as the hierarchical model. For TP block, TPNR, TPKPJ and TPRESA have also been used and for BF block, UTNR has been used.

Observation labels

Primary ID	Secondary ID	Primary ID	Secondary ID
LD1TSRT	<i>Observation label</i>	ANABOM234	<i>Observation label</i>
SENR	<i>Observation label</i>	ANABOM236	<i>Observation label</i>
GLKPJ	<i>Observation label</i>	ANABOM340	<i>Observation label</i>
GLNR	<i>Observation label</i>	ANABOMEBEL	<i>Observation label</i>
GJAVBRKD	<i>Observation label</i>	PQDATUM	<i>Observation label</i>
GJVESTTI	<i>Observation label</i>	SKRESA	<i>Observation label</i>
ST5GLST	<i>Observation label</i>	SKNR	<i>Observation label</i>
GJLOPNR	<i>Observation label</i>	SKKPJ	<i>Observation label</i>
GJPLNORM	<i>Observation label</i>	LD1LAPG	<i>Observation label</i>
GJPLSTR	<i>Observation label</i>	LD1SPGM	<i>Observation label</i>
ST5GLVE	<i>Observation label</i>	LD1UTGR	<i>Observation label</i>
ST5GRVE	<i>Observation label</i>	LD4LANR	<i>Observation label</i>
ST5KONR	<i>Observation label</i>	LD4LARS1	<i>Observation label</i>
ST5STNR	<i>Observation label</i>	LD4LARS2	<i>Observation label</i>
ST5GVTI	<i>Observation label</i>	LD4UGKR	<i>Observation label</i>
ST5GSNR	<i>Observation label</i>	LD4UGRS	<i>Observation label</i>
PRFEL	<i>Observation label</i>	LD6ORSA1	<i>Observation label</i>
EBTSTTI	<i>Observation label</i>	LD7SKIF	<i>Observation label</i>
STALAN_SU_SSNR	<i>Observation label</i>	LD9KOK	<i>Observation label</i>
EBVHSTI	<i>Observation label</i>	LD8BOMA	<i>Observation label</i>
KTSKLAG234	<i>Observation label</i>	LD1LBE	<i>Observation label</i>
KTTRAFF234	<i>Observation label</i>	LSBEBEH	<i>Observation label</i>
KTBOOR234	<i>Observation label</i>	ANABOM230	<i>Observation label</i>
KTSKLAG236	<i>Observation label</i>	KTSKLAG230	<i>Observation label</i>
KTTRAFF236	<i>Observation label</i>	KTTRAFF230	<i>Observation label</i>
KTBOOR236	<i>Observation label</i>	PQDATUM	<i>Observation label</i>
KTSKLAG321	<i>Observation label</i>	SKNR	<i>Observation label</i>
KTTRAFF321	<i>Observation label</i>	SKKPJ	<i>Observation label</i>
KTBOOR321	<i>Observation label</i>	SKRESA	<i>Observation label</i>
KTSKLAG341_2	<i>Observation label</i>	DTVIKT	<i>Observation label</i>
KTTRAFF341_2	<i>Observation label</i>	PQDATUM	<i>Observation label</i>
KTBOOR341_2	<i>Observation label</i>	Totvikt	<i>Observation label</i>

Variables in the blast furnace block

Primary ID	Secondary ID
C	BFVAR001
Si	BFVAR002
Mn	BFVAR003
P	BFVAR004
S_iron	BFVAR005
Cr	BFVAR006
Cu	BFVAR007
Ni	BFVAR008
Ti	BFVAR009
V	BFVAR010
Temp	BFVAR011
DiffSi	BFVAR012
DiffMn	BFVAR013
DiffP	BFVAR014
DiffS	BFVAR015
DiffCr	BFVAR016
DiffCu	BFVAR017
DiffNi	BFVAR018
DiffV	BFVAR019
DiffTemp	BFVAR020
ANMISSANT	BFVAR021
EFT_STOP	BFVAR022
Tapptid	BFVAR023
Slaggtid	BFVAR024
CaO	BFVAR025
SiO2	BFVAR026
Al2O3	BFVAR027
MgO	BFVAR028
FeO	BFVAR029

Primary ID	Secondary ID
MnO	BFVAR030
S_slag	BFVAR031
TiO2	BFVAR032
V2O5	BFVAR033
K2O	BFVAR034
B2	BFVAR035
B3	BFVAR036
Längd	BFVAR037
K-streck	BFVAR038
B-diam	BFVAR039
Grytor	BFVAR040
Grovkoks (9201)	BFVAR041
Finkoks (9203)	BFVAR042
Injektkol (9990)	BFVAR043
MPBO (9248)	BFVAR044
KPBA (9944)	BFVAR045
Mn-briketter (1055)	BFVAR046
Kalksten (9210)	BFVAR047
LD-sten (9208)	BFVAR048
Bränslebriketter (1056)	BFVAR049
Skrot (9236)	BFVAR050
MnSot-briketter (1057)	BFVAR051
Kvartsit (9966)	BFVAR052
Blästermängd	BFVAR053
Blästertemp	BFVAR054
Syrgas i bläster	BFVAR055
Toppgasflöde	BFVAR056
Temp forma1	BFVAR057
Temp forma20	BFVAR058

Variables in the desulphurization block

Primary ID	Secondary ID
TAC1	TPVAR001
TASi1	TPVAR002
TAMn1	TPVAR003
TAP1	TPVAR004
TAS1	TPVAR005
TACr1	TPVAR006
TANi1	TPVAR007
TAV1	TPVAR008
TATi1	TPVAR009
TACu1	TPVAR010
TAC2	TPVAR011
TASi2	TPVAR012
TAMn2	TPVAR013
TAP2	TPVAR014
TAS2	TPVAR015
TACr2	TPVAR016
TANi2	TPVAR017
TAV2	TPVAR018
TATi2	TPVAR019
TACu2	TPVAR020
SABS_F	TPVAR021
SABS_E	TPVAR022
SRVETOTI	TPVAR023
LDACDVK1	TPVAR024
LDACD_SABS	TPVAR025
LDACREK1	TPVAR026
LDADIFF1	TPVAR027
LDAHTMP	TPVAR028
LDAMATN1	TPVAR029
LDASTMP1	TPVAR030
LDATARA	TPVAR031
LDATVKT	TPVAR032
LDASHLB1	TPVAR033
LDASMISS	TPVAR034
LDSRANT	TPVAR035
LDASHLH	TPVAR036
LDATNIV	TPVAR037

Variables in the LD-converter block

Primary ID	Secondary ID
LSINSVKT	LDVAR001
LSVEVIKT	LDVAR002
OSANC	LDVAR003
OSANSi	LDVAR004
OSANMn	LDVAR005
OSANP	LDVAR006
OSANS	LDVAR007
OSANCr	LDVAR008
OSANNi	LDVAR009
OSANMo	LDVAR010
OSANV	LDVAR011
OSANTi	LDVAR012
OSANCu	LDVAR013
LD3N2TO	LDVAR014
LD3ARTO	LDVAR015
LD6DOTO	LDVAR016
LD6FUTO	LDVAR017
LD6KATO	LDVAR018
LD6MATO	LDVAR019
LD6O2TO	LDVAR020
LD7FPTP1	LDVAR021
LD7TPTP1	LDVAR022
LD1TNTE	LDVAR023
BLTITOT	LDVAR024
BLANT	LDVAR025
BEHTIDTOT	LDVAR026
FUANT	LDVAR027
KAANT	LDVAR028
LAH00	LDVAR029
LAH35	LDVAR030
LAH50	LDVAR031
LAH60	LDVAR032
LAH80	LDVAR033
MAANT	LDVAR034
LD2RATP	LDVAR035
LD8ALBE	LDVAR036
LDLGE5018	LDVAR037
LDLGE5020	LDVAR038
LDLGE5120	LDVAR039
LDLGE5017	LDVAR040
LDLGE5061	LDVAR041
LDLGE5045	LDVAR042

Primary ID	Secondary ID
LDLGN5063	LDVAR043
LDLGN5307	LDVAR044
LDLGN5308	LDVAR045
LDLGN5008	LDVAR046
LDLGN5218	LDVAR047
LDLGN6501	LDVAR048
LD7SONT	LDVAR049
LD7SONO	LDVAR050
LD7SONC	LDVAR051
LDDOLANT	LDVAR052
LDSKT02	LDVAR053
LDSKT03	LDVAR054
LDSKT05	LDVAR055
LDSKT12	LDVAR056
LDSKT21	LDVAR057
LDSKT23	LDVAR058
LDSKT25	LDVAR059
LDSKT26	LDVAR060
LDSKT2X	LDVAR061
LDSKT33	LDVAR062
LDSKT35	LDVAR063
LDSKT50	LDVAR064
LDSKTYLW	LDVAR065
LDSKT54	LDVAR066
LDSKT55	LDVAR067
LDSKT56	LDVAR068
LDSKTGREEN	LDVAR069
LDSKT60	LDVAR070
LDSKT90	LDVAR071
LDSKT95	LDVAR072
LD9SLE	LDVAR073
GACaO	LDVAR074
GASiO2	LDVAR075
GAAI2O3	LDVAR076
GAMgO	LDVAR077
GAFeO	LDVAR078
GAMnO	LDVAR079
GAP2O5	LDVAR080
GAS	LDVAR081
GACr2O3	LDVAR082
GAV2O5	LDVAR083
GATiO2	LDVAR084

Primary ID	Secondary ID
GABas	LDVAR085
LAANC230	LDVAR086
LAANSi230	LDVAR087
LAANMn230	LDVAR088
LAANP230	LDVAR089
LAANS230	LDVAR090
LAANCr230	LDVAR091
LAANNi230	LDVAR092
LAANMo230	LDVAR093
LAANV230	LDVAR094

Primary ID	Secondary ID
LAANTi230	LDVAR095
LAANCu230	LDVAR096
LAANAI230	LDVAR097
LAANNb230	LDVAR098
LAANB230	LDVAR099
LAANN230	LDVAR100
LAANSn230	LDVAR101
KTMISS230	LDVAR102
KTMATT230	LDVAR103
LD9KOK	LDVAR104

Variables in the secondary steelmaking block

Primary ID	Secondary ID
EBTBGASANT	SSVAR001
EBTBLTITOT	SSVAR002
EBTGASMGD	SSVAR003
EBTTLTR1	SSVAR004
EBTTLTR2	SSVAR005
EBTVSUM	SSVAR006
EBTLE5007	SSVAR007
EBTLE5018	SSVAR008
EBTLE5021	SSVAR009
EBTLE5030	SSVAR010
EBTLE5035	SSVAR011
EBTLE5045	SSVAR012
EBTLE5063	SSVAR013
EBTLE5121	SSVAR014
EBTLE5218	SSVAR015
EBTLE5230	SSVAR016
EBTLE5236	SSVAR017
EBTLE5303	SSVAR018
EBTLE5401	SSVAR019
EBTLE5499	SSVAR020
EBTXLTS	SSVAR021
EBXTESL	SSVAR022
EBXTTTS	SSVAR023
EBTSTTV	SSVAR024
EBVHBHT	SSVAR025
EBVEANT	SSVAR026
EBVETOTI	SSVAR027
EBVHKWT	SSVAR028
EBVHKWTOT	SSVAR029
EBVGBTOTI	SSVAR030

Primary ID	Secondary ID
EBVHSB01	SSVAR031
EBVHSB02	SSVAR032
EBVHSB03	SSVAR033
EBVHSB04	SSVAR034
EBVHSB05	SSVAR035
EBVFSTOTI	SSVAR036
EBVACBEH	SSVAR037
EBVHVP1	SSVAR038
EBVHV101	SSVAR039
EBVHANG	SSVAR040
EBVHTEM1	SSVAR041
EBVHSTV	SSVAR042
EBSXNTS	SSVAR043
EBSXNTS	SSVAR044
EBSULGN5009	SSVAR045
EBSULGN5018	SSVAR046
EBSULGN5021	SSVAR047
EBSULGN5030	SSVAR048
EBSULGN5036	SSVAR049
EBSULGN5045	SSVAR050
EBSULGN5046	SSVAR051
EBSULGN5063	SSVAR052
EBSULGN5121	SSVAR053
EBSULGN5218	SSVAR054
EBSULGN5232	SSVAR055
EBSULGN5235	SSVAR056
EBSULGN5236	SSVAR057
EBSULGN5241	SSVAR058
EBSULGN5303	SSVAR059
EBSULGN5307	SSVAR060

Primary ID	Secondary ID
EBSULGN5401	SSVAR061
EBSULGN5404	SSVAR062
EBSULGN5499	SSVAR063
EBSULGN6502	SSVAR064
EBSULGN6605	SSVAR065
EBSULGN6610	SSVAR066
EBCHNST	SSVAR067
EBVHKRNS	SSVAR068
EBSXLTS	SSVAR069
KTMATT234	SSVAR070
KTMISS234	SSVAR071
KTMATT236	SSVAR072
KTMISS236	SSVAR073
KTMATT321	SSVAR074
KTMISS321	SSVAR075
KTMATT341_2	SSVAR076
KTMISS341_2	SSVAR077
LAANCEB	SSVAR078
LAANSiEB	SSVAR079
LAANMnEB	SSVAR080
LAANPEB	SSVAR081
LAANSEB	SSVAR082
LAANCrEB	SSVAR083
LAANNiEB	SSVAR084
LAANMoEB	SSVAR085
LAANVEB	SSVAR086
LAANTIEB	SSVAR087
LAANCuEB	SSVAR088
LAANAIEB	SSVAR089
LAANNbEB	SSVAR090
LAANBEB	SSVAR091
LAANNEB	SSVAR092
LAANN321	SSVAR093
ANANC1	SSVAR094
ANANSi1	SSVAR095
ANANMn1	SSVAR096
ANANP1	SSVAR097
ANANS1	SSVAR098
ANANCr1	SSVAR099
ANANNi1	SSVAR100
ANANMo1	SSVAR101
ANANV1	SSVAR102
ANANTI1	SSVAR103
ANANCu1	SSVAR104

Primary ID	Secondary ID
ANANA1	SSVAR105
ANANNb1	SSVAR106
ANANB1	SSVAR107
ANANN1	SSVAR108
ANANZn1	SSVAR109
ANANCa1	SSVAR110
ANANCo1	SSVAR111
ANANAs1	SSVAR112
ANANSn1	SSVAR113
ANANPb1	SSVAR114
ANANCe1	SSVAR115
ANANC2	SSVAR116
ANANSi2	SSVAR117
ANANMn2	SSVAR118
ANANP2	SSVAR119
ANANS2	SSVAR120
ANANCr2	SSVAR121
ANANNi2	SSVAR122
ANANMo2	SSVAR123
ANANV2	SSVAR124
ANANTI2	SSVAR125
ANANCu2	SSVAR126
ANANAi2	SSVAR127
ANANNb2	SSVAR128
ANANB2	SSVAR129
ANANN2	SSVAR130
ANANZn2	SSVAR131
ANANCa2	SSVAR132
ANANCo2	SSVAR133
ANANAs2	SSVAR134
ANANSn2	SSVAR135
ANANPb2	SSVAR136
ANANCe2	SSVAR137
ANANH1	SSVAR138
ANANH2	SSVAR139
AVVIKC	SSVAR140
AVVIKSI	SSVAR141
AVVIKMN	SSVAR142
AVVIKP	SSVAR143
AVVIKS	SSVAR144
AVVIKCR	SSVAR145
AVVIKNI	SSVAR146
AVVIKMO	SSVAR147
AVVIKV	SSVAR148

Primary ID	Secondary ID
AVVIKTI	SSVAR149
AVVIKCU	SSVAR150
AVVIKAL	SSVAR151

Primary ID	Secondary ID
AVVIKNB	SSVAR152
AVVIKB	SSVAR153
AVVIKN	SSVAR154

Variables in the continuous casting block

Primary ID	Secondary ID
GJBUTVKT	CCVAR001
GJLADRUS	CCVAR002
GJPLVIKT	CCVAR003
GJTJL	CCVAR004
GJUTGLGD	CCVAR005
GJVETOTI	CCVAR006
GJVETLIQ	CCVAR007
ST5GLSK	CCVAR008
ST5GSRS	CCVAR009
ST5KBVV	CCVAR010
ST5KBVS	CCVAR011
ST5KOAC	CCVAR012
ST5KOKO	CCVAR013
ST5KTVV	CCVAR014
ST5SLGV	CCVAR015
ST5STSM	CCVAR016
ST5STSS	CCVAR017
ST5GLCH	CCVAR018
ST5BZNR	CCVAR019
ST5GJBZ	CCVAR020
ST5GLSI	CCVAR021
ST5GLT01	CCVAR022
ST5GLT02	CCVAR023
ST5GLT03	CCVAR024
ST5GLT04	CCVAR025
ST5GJLG	CCVAR026
ST5KF01	CCVAR027
ST5KF02	CCVAR028
ST5KF03	CCVAR029
ST5KF04	CCVAR030
ST5KF05	CCVAR031
ST5KF06	CCVAR032
ST5KF07	CCVAR033
ST5KF08	CCVAR034
ST5KF09	CCVAR035
ST5KF10	CCVAR036
ST5KF11	CCVAR037

Primary ID	Secondary ID
ST5KF12	CCVAR038
ST5KF13	CCVAR039
ST5KF14	CCVAR040
ST5KF15	CCVAR041
ST5KF16	CCVAR042
ST5KF17	CCVAR043
ST5KF18	CCVAR044
ST5KF19	CCVAR045
ST5KF20	CCVAR046
ST5KV01	CCVAR047
ST5KV02	CCVAR048
ST5KV03	CCVAR049
ST5KV04	CCVAR050
ST5KV05	CCVAR051
ST5KV06	CCVAR052
ST5KV07	CCVAR053
ST5KV08	CCVAR054
ST5KV09	CCVAR055
ST5KV10	CCVAR056
ST5KV11	CCVAR057
ST5KV12	CCVAR058
ST5KV13	CCVAR059
ST5KV14	CCVAR060
ST5KV15	CCVAR061
ST5KV16	CCVAR062
ST5KV17	CCVAR063
ST5KV18	CCVAR064
ST5KV19	CCVAR065
ST5KV20	CCVAR066
AEMAXBRD	CCVAR067
AEDITOTI	CCVAR068
AESTARTH	CCVAR069
AEEJOKFRAC	CCVAR070
AEANHITH	CCVAR071
AAANCMAX	CCVAR072
AAANSiMAX	CCVAR073
AAANMnMAX	CCVAR074

Primary ID	Secondary ID
AAANPMAX	CCVAR075
AAANSMAX	CCVAR076
AAANCrMAX	CCVAR077
AAANNiMAX	CCVAR078
AAANMoMAX	CCVAR079
AAANVMAX	CCVAR080
AAANTiMAX	CCVAR081
AAANCuMAX	CCVAR082
AAANAiMAX	CCVAR083
AAANNbMAX	CCVAR084
AAANBMAX	CCVAR085
AAANNMAX	CCVAR086
AAANZnMAX	CCVAR087
AAANCaMAX	CCVAR088
AAANCoMAX	CCVAR089
AAANAsMAX	CCVAR090
AAANSnMAX	CCVAR091
AAANPbMAX	CCVAR092
AAANCeMAX	CCVAR093
AAANCMIN	CCVAR094
AAANSiMIN	CCVAR095
AAANMnMIN	CCVAR096
AAANPbMIN	CCVAR097
AAANSiMIN	CCVAR098
AAANCrMIN	CCVAR099
AAANNiMIN	CCVAR100
AAANMoMIN	CCVAR101
AAANVMIN	CCVAR102
AAANTiMIN	CCVAR103
AAANCuMIN	CCVAR104
AAANAiMIN	CCVAR105
AAANNbMIN	CCVAR106
AAANBMIN	CCVAR107
AAANNMIN	CCVAR108
AAANZnMIN	CCVAR109
AAANCaMIN	CCVAR110
AAANCoMIN	CCVAR111

Primary ID	Secondary ID
AAANAsMIN	CCVAR112
AAANSnMIN	CCVAR113
AAANPbMIN	CCVAR114
AAANCeMIN	CCVAR115
AAANCSTD	CCVAR116
AAANSiSTD	CCVAR117
AAANMnSTD	CCVAR118
AAANPSTD	CCVAR119
AAANSSTD	CCVAR120
AAANCrSTD	CCVAR121
AAANNiSTD	CCVAR122
AAANMoSTD	CCVAR123
AAANVSTD	CCVAR124
AAANTiSTD	CCVAR125
AAANCuSTD	CCVAR126
AAANAISTD	CCVAR127
AAANNbSTD	CCVAR128
AAANBSTD	CCVAR129
AAANNSTD	CCVAR130
AAANZnSTD	CCVAR131
AAANCaSTD	CCVAR132
AAANCoSTD	CCVAR133
AAANAsSTD	CCVAR134
AAANSnSTD	CCVAR135
AAANPbSTD	CCVAR136
AAANCeSTD	CCVAR137
AVFRACFEL	CCVAR138
PRUNDBET	CCVAR139
PRCENBET	CCVAR140
PRHWLAUT	CCVAR141
PRHWLAUK	CCVAR142
PRCQAUTO	CCVAR143
PRCQAUTK	CCVAR144
PRBRVSEG	CCVAR145
PRHWFAUT	CCVAR146
PRHWFAUK	CCVAR147
PRFEL	CCVAR148