



CHALMERS
UNIVERSITY OF TECHNOLOGY



Driver Influence on Vehicle Track-Ability on Floating Bridges

Bachelor's thesis in Mechanical Engineering

Adam Gustafsson, Christian Svensson, Ivan Berg,
Jonas Johnsson, Moa Lubell

BACHELOR'S THESIS 2019:22

Driver Influence on Vehicle Track-Ability on Floating Bridges

Adam Gustafsson
Christian Svensson
Ivan Berg
Jonas Johnsson
Moa Lubell



Department of Mechanics and Maritime Sciences
Division of Vehicle Engineering and Autonomous Systems
Vehicle Dynamics
CHALMERS UNIVERSITY OF TECHNOLOGY
Gothenburg, Sweden 2019

Driver Influence on Vehicle Track-Ability on Floating Bridges
Jonas Johnsson, Christan Svensson, Ivan Berg, Moa Lubell, Adam Gustafsson

© Adam Gustafsson, Christan Svensson, Ivan Berg, Jonas Johnsson, Moa Lubell
2019.

Supervisor: Ingemar Johansson, CEVT and Vehicle Engineering and Autonomous
Systems

Supervisor: Dragan Sekulic, Vehicle Engineering and Autonomous Systems

Examiner: Bengt Jacobson, Vehicle Engineering and Autonomous Systems

Bachelor's Thesis 2019:22

Department of Mechanics and Maritime Sciences

Division of Vehicle Engineering and Autonomous Systems

Vehicle Dynamics group

Chalmers University of Technology

SE-412 96 Gothenburg

Telephone +46 31 772 1000

Cover: Photo showing one of the drivers in the simulator study driving over the
Bjørnafjorden floating bridge in a passenger sedan car.

Typeset in L^AT_EX

Gothenburg, Sweden 2019

Driver Influence on Vehicle Track-Ability on Floating Bridges
Adam Gustafsson, Christan Svensson, Ivan Berg, Jonas Johnsson, Moa Lubell
Department of Mechanics and Maritime Sciences
Chalmers University of Technology

Abstract

The Norwegian highway route E39 consists of many different ferry connections, which results in a travel time of 21 hours for a travel distance of 1100 km from Kristiansand to Trondheim. The Norwegian government has therefore decided to invest in new infrastructure, which would reduce the travel time to about half. One of these solutions are to implement floating bridges. Floating bridges have the capacity to cross large distances such as fjords, but would also introduce motion to the vehicles driving upon it. Having waves and wind affecting the bridge, and crosswind directly affecting the vehicle, makes it difficult to assess the problem using existing theoretical methods. Therefore, a method to investigate how a moving road surface will affect the vehicle and the driver needs to be developed in this project. The study utilized a industry-grade motion driver-in-the-loop simulator. This report describes how the method for testing these driving conditions was achieved and assesses the validity of using such method. The conclusion was that the method of evaluating the driver influence on track-ability on floating bridges is functional.

Keywords: simulator, vehicle dynamics, NPRA, floating bridge, motion simulation, Simulink, driver-in-the-loop, Cruden, Bjørnafjorden

Acknowledgements

The thesis group would like to thank the supervisors Ingemar Johansson and Dragan Sekulic for their time and devotion to this project. Their guidance and knowledge proved to be invaluable for the result of this project. We would also like to thank the examiner of this project, Bengt Jacobsson, who also provided expertise and knowledge in the subject throughout the project. Also a big thank you to Caster for giving us access to their facility and simulator. Lastly, the project would not have been such a success without the help from Stian Moe Johannessen at the Norwegian Public Road Administration, who assisted the project with 3D models of the bridge.

Adam Gustafsson, Christan Svensson, Ivan Berg, Jonas Johnsson, Moa Lubell
Gothenburg, May 2019

Abbreviations

Abbreviation	Description
ALGLIB	Programming library for numerical analysis
CAD	Computer Aided Design
CoG	Center of gravity
MEX	Precompiled Matlab or Simulink function
MF	Magic Formula
NPRA	Norwegian Public Roads Administration
OEM	Original Equipment Manufacturer
RMS	Root Mean Square



Contents

1	Introduction	1
1.1	Background	1
1.2	Problem description	1
1.3	Objective	2
1.4	Deliverables	3
1.5	Limitations	3
1.6	Social and ethical aspects	3
2	Theory	5
2.1	Motion simulator	5
2.1.1	Panthera and simulation environment	6
2.1.2	Vehicle models	6
2.1.3	Motion cueing	7
2.2	Vehicle dynamics	7
2.2.1	Tires	8
2.2.1.1	Longitudinal dynamics	8
2.2.1.2	Lateral dynamics	10
2.2.1.3	Magic Formula tire model	11
2.2.2	Suspension	12
2.2.2.1	Steering effects	14
2.2.2.2	Suspension types	15
2.2.3	Aerodynamic loads	17
2.2.4	Heavy vehicles	18
2.3	Vehicle on a moving road surface	19
2.3.1	Dynamic conditions of a floating bridge	19
2.3.2	Existing floating bridge	20
2.3.3	Effects of earthquakes	20
2.3.4	Motion data for floating bridge in Bjørnafjorden	21
2.3.5	Simulator testing	22
3	Methods	23
3.1	Vehicle modeling	23
3.1.1	Car model	26
3.1.2	Bus model	26
3.2	Wind and wave data	27
3.3	Graphical environment model	28

3.4	Driving trials	29
4	Results	31
4.1	Test method	31
4.2	Results from driving the passenger car	32
4.2.1	Staying in lane	32
4.2.2	Comfort	37
4.3	Results from driving the bus	39
4.3.1	Staying in lane	39
4.3.2	Comfort	44
4.4	Overall results from simulator	45
5	Discussion	47
5.1	General	47
5.2	Vehicle model	47
5.3	Future work	48
5.3.1	Driving experience - Visual	48
5.3.2	Driving experience - Soundscape	48
5.3.3	Vehicle model - Driveline	48
5.3.4	Vehicle model - Tire model	49
5.3.5	Vehicle model - Bridge roll	49
5.3.6	Vehicle model - Suspension	49
5.3.7	General Simulink improvements	49
5.3.8	Vehicle model - Validation	49
5.3.9	Driving trials	50
6	Conclusion	51
	Bibliography	53
A	Simulink model	I
B	Bus parameters	III
C	Questionnaire	V
C.1	Car model	V
C.2	Bus model	VII
C.3	Overall questions	VIII
D	Results of questionnaire	IX
D.1	Scenario 1, car	IX
D.2	Scenario 2, car	XII
D.3	Scenario 1, bus	XIV
D.4	Scenario 2, bus	XV
D.5	Overall questions	XVII

1

Introduction

This chapter will present the scope of the project. It will describe what will be performed, why it is performed, and what areas of research will be focused on.

1.1 Background

The Norwegian Public Roads Administration (NPRA), is working on a project to improve the coastal highway route E39. The route stretches along the west coast of Norway, from Kristiansand to Trondheim, and is approximately 1100 km long. The travel time of the route is today around 21 hours due to seven different ferry connections. NPRA's aim is to improve the highway by removing the necessity of ferries, which would decrease the travel time to 11 hours, by introducing bridges and tunnels instead. This requires new methods for a number of large fjord crossings because of the depth and width of the fjords. NPRA are considering different solutions for this, for example a floating bridge with inspiration from the technology currently employed by the offshore sector. This bridge is considered to be the most cost efficient and strives to use the least amount of materials, but will result in a bridge with a higher level of road surface movement. This type of bridge will be built over Bjørnafjorden, which has a width of 5 km and a depth of 550 m. The project has been tasked with investigating this bridge.

NPRA is collaborating with the department of Vehicle Engineering and Autonomous Systems (VEAS) at Chalmers University of Technology. Other universities involved in this project are Norwegian University of Science and Technology (NTNU), University of Stavanger, University of Bergen (UiS) and Technical University of Denmark (DTU).

1.2 Problem description

To analyze a driver's response to a moving road surface is a difficult task to perform in reality. This is because there are no such roads available for testing and evaluating, and the risk when performing these tests would be too dangerous to properly evaluate for different conditions. Therefore, using a simulator to test different conditions is the most viable solution.

The vertical and lateral floating bridge movements might have effects on the vehicle behavior in vertical (e.g. ride comfort), lateral (e.g. vehicle stability) and longitudinal (e.g. braking/accelerating) directions. Also, bridge motion and vehicle behavior might have effects on a driver's ability to follow traffic and stay in lane, see figure 1.1.

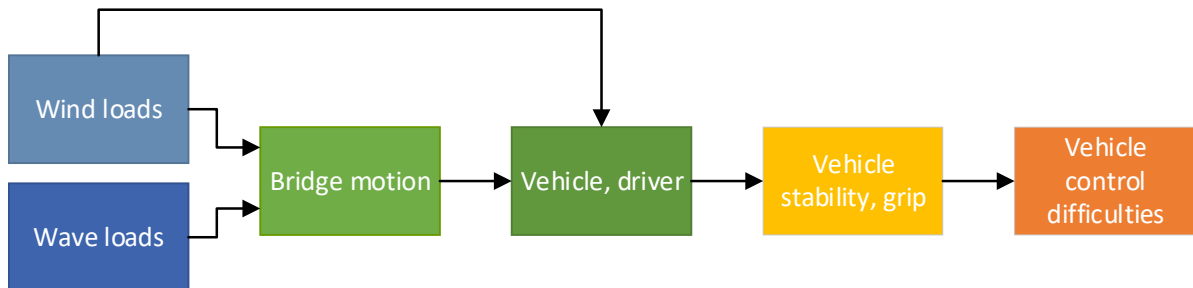

Figure 1.1: Flowchart describing the sequence of events that affect the driver and the vehicle.

With today's complex simulator systems, an accurate representation of a vehicle's dynamic response to surface movements is accessible. To be able to test with a driver in a simulator will prove to be valuable when evaluating if the different conditions are suitable for actual driving. Therefore this project aims to create a driving simulator setup in Caster's simulator.

1.3 Objective

The objective of the project is to develop a method for investigating how a moving road surface will affect the vehicle and the driver. A part of this is to develop functioning vehicle models in Simulink for simulating a passenger car and a bus. The reason for also developing a bus is due to its sensitivity to crosswinds in comparison to a passenger car. These will be integrated with Caster's motion simulator, which is situated at the mechanical engineering program at Chalmers University of Technology.

A driver study will be performed to validate the developed method's applicability for use in future investigations. The validation will through objective and subjective measurements assess if the vehicle models and simulator environment produces an expected response to different storm conditions.

1.4 Deliverables

The deliverables for this project are the following:

- To develop a method to investigate how a moving road surface will affect the vehicle and the driver
- A functional Simulink model of the passenger car and a bus for investigation of their dynamic behavior due to the loads from bridge motion and wind
- A graphic model of a floating bridge
- A driving trial with several drivers
- A compilation of results from the driving trials
- Analyze how the result will affect the driver and the vehicle
- To identify remaining issues and document these in the "future work" chapter of the report

1.5 Limitations

The project has a number of limitations to take in consideration. These constrain the project's scope to:

- Analyze a straight floating bridge
- Start from an existing vehicle model in Simulink
- Simulate a passenger car and a rigid bus with two axles
- Use Caster's motion simulator
- Analyze the bus with maximum load
- Analyze high friction road conditions without traffic
- Analyze weather conditions such as crosswind and waves without bridge rolling

1.6 Social and ethical aspects

The ethical aspects raised in this report focuses on the safety and comfort for the driver while driving on a moving surface. Driver safety is very important, and a study of this sort can provide information about problems with driving ability on a floating bridge. The results of this report will be acknowledged by the NPRA. This project does not consider the ethical dilemmas of building the bridge, regarding its impact on the environment and the sociopolitical agendas behind it.

For this project, trials will be used as a method to evaluate a driver's ability to effectively travel over a moving bridge. The drivers will be volunteers and confidential. The skill level of the drivers that are selected for the driving trials will need to be part of the assessment of the result.

2

Theory

This chapter further explains the necessary knowledge to understand the following parts of the report. The writing of this chapter was also an integral part in the development of the method.

2.1 Motion simulator

The project utilizes a Hexatech 1CTR driver-in-the-loop simulator which is manufactured by Cruden, see figure 2.1. The simulator is situated at the Mechanical Engineering program at Chalmers University of Technology and is managed by the student organization Caster. It uses six actuators to simulate motion from a vehicle model with 6 degrees of freedom. The platform can momentarily generate 1,5 G of acceleration and has a maximum stroke of 640 mm. It has a seat, steering wheel, three pedals (clutch, brake, accelerator), a dashboard and three screens for the driver's field of view. The driver can choose between using paddles or a gear stick for shifting.



Figure 2.1: Picture of the simulator [7].

2.1.1 Panthera and simulation environment

The simulator uses Panthera, a software developed by Cruden. Panthera communicates with the motion platform and has the ability to work with different, external or internal, vehicle models, see figure 2.2. Panthera also renders the graphical environment.

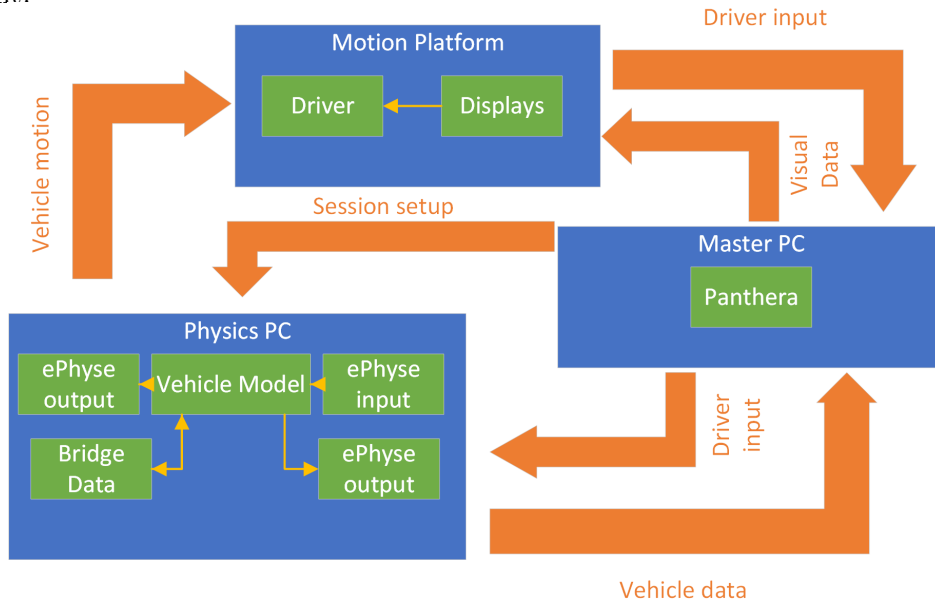

Figure 2.2: Diagram of simulation running on external physics.

2.1.2 Vehicle models

The simulator can model vehicles in two ways: using the so called internal vehicle model, or a model in Simulink via the ePhyseNet interface. The ePhyseNet interface handles the communication between the Panthera software and Simulink, an example being the tire-surface interaction. Running the simulation in Simulink using ePhyseNet results the simulation running in so called soft realtime, which means that the simulation tries to run in real time, but it is not system critical if it momentarily slows down.

The internal vehicle model is a black-box model where the vehicle is modeled by changing defined parameters in a configuration file. This method is generally easier to use because of not having to actually model all the vehicle subsystems, but is also limited due to this same reason.

Modeling in Simulink is more complex due to every subsystem having to be reconstructed. This can be eased by using an existing model, which this project will be doing. Cruden supplies the Panthera software together with a high-detail Simulink model called Cruden Simulink Vehicle Model, or CSVM for short. There is no out-of-the-box implementation of a moving road surface interacting on the model, which this project will resolve. The model is available for free and is open to modify for the specific use case. Unmodified, the CSVM model simulates a generic sedan passenger vehicle.

2.1.3 Motion cueing

Motion cueing is an important part of this project as it is the translation of the vehicle model to physical motion. It takes measurements from the vehicle model and calculates how the platform should move, which is necessary because the platform is confined in a sphere of motion. Thus, a way to create motion in such a way that it is perceived as a realistic representation of reality is needed.

2.2 Vehicle dynamics

Vehicle dynamics is the study of analyzing the movements of a vehicle on a road surface and the various forces that act upon the vehicle when it is in motion. Dynamic behavior is determined by the forces imposed on the vehicle from the tires, gravity and aerodynamics. It is important to understand how the vehicle will respond to these forces to improve the ability to control the vehicle [12].

Vehicle motion is described by the translational movements in the longitudinal, lateral and vertical directions along with rotational movements in the yaw, pitch and roll axes. In figure 2.3 this is illustrated on a passenger car.

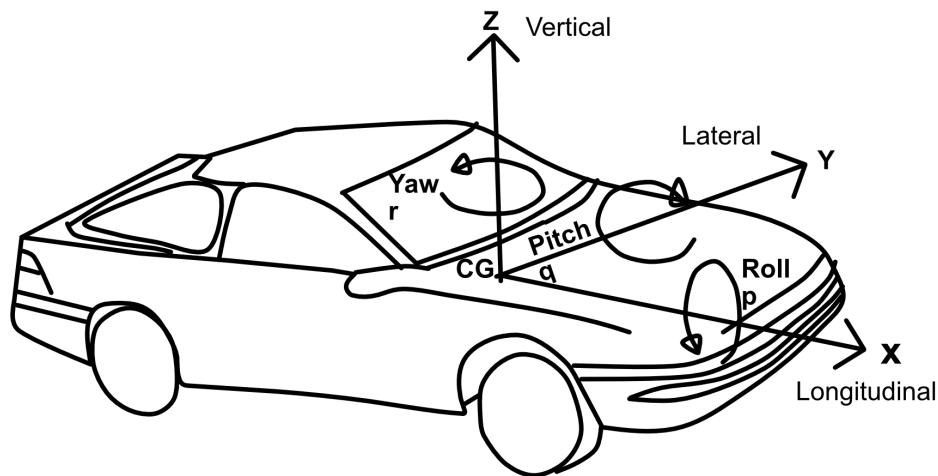

Figure 2.3: Illustration of translational and rotational movements of a vehicle body.

These movements are referenced to the earth fixed coordinate system with respect to the vehicle fixed coordinate system. The vehicle is often represented as one mass located at its center of gravity, CoG, with appropriate mass and inertia properties. The point mass at the CoG is dynamically equivalent to the vehicle for all motions in which it is reasonable to assume the vehicle to be rigid [12].

When vehicles are operated on roads, vertical dynamics are needed to maintain tire-road contact and isolate the car from road imperfections. To ensure this, a suspension system is implemented on the car [14].

To be able to follow the road's curves and laterally avoid obstacles, lateral motion of a vehicle is needed. Lateral dynamics define how steerable the vehicle is [14].

2.2.1 Tires

The tires are responsible for connecting the vehicle to the road surface via the tire's contact patch. It is in the contact patch where the largest load transfers to the vehicle body occur.

The tire's purpose can be broken down into three functions:

1. Support the vehicle's weight (vertical forces)
2. Provide grip for braking and acceleration (longitudinal forces)
3. Provide grip for cornering and sideways stability (lateral forces)

The way that the tires are able to transfer loads has an impact on the vehicle's handling and ride characteristics, and consequently ride comfort, safety and fuel efficiency. It is therefore an area of vehicle dynamics that is vehemently studied by researchers.

This thesis work will focus on understanding the longitudinal and lateral forces involved. This is because the performance of braking, cornering and sideways stability will determine whether safe driving can be conducted on a moving bridge with lateral winds.

Lastly, an important aspect of today's development work within vehicle dynamics is tire modeling using mathematical models. The section 2.2.1.3 will briefly cover Pacejka's Magic Formula as it is the model used in the Simulink vehicle model.

2.2.1.1 Longitudinal dynamics

The tire is used for propelling the vehicle forward and does so by transmitting the rotational velocity and torque of the axle to the road and thus creating translational movement. While an analogy can be drawn to a rack and pinion system for explaining the conversion, a tire, unlike a cog, will substantially deflect and slip on the surface. This adds complexity to the analysis.

An easy explanation for how tires are able to generate forces can be found in [17]. Longitudinal loads are generated from vertical loads and the friction contact between the two surfaces. Imagine dragging a rubber eraser on a table, keeping the downwards pressure constant. Doing this, the eraser will start deforming with added dragging force, much like a spring. The deformation occurs near the table (the contact patch) and will generate a reaction force (a friction force) in the opposing direction of travel. The eraser will keep on deforming in a linear fashion with added force until it starts sliding. The reaction force will further increase, non-linearly, with further deformation until a peak force is obtained. This is how a tire is able to generate forces in simple terms. The key takeaway from this is that deformation is

needed for generating tractive forces.

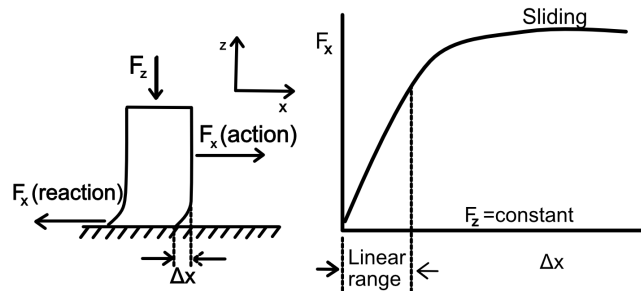

Figure 2.4: Illustration of how the friction force relates to a dragging force, recreated from [17].

To describe the relationship between the wheel's rotational velocity and the vehicles translational velocity, the slip-ratio is used. For longitudinal tire slip, the formula is as following:

$$s_x = \frac{R\omega - v_x}{|R\omega|} \quad (2.1)$$

, where R is the effective tire rolling radius, ω the wheel's rotational velocity, v_x the wheel's translational velocity.

When a new section of the tread enters the contact patch, the rubber has to deform to generate a friction force. To do this, the velocity of the section has to be higher than that of the circumferential velocity. The difference in velocity causes a slip that is always prevalent when rolling [14]. This means that for even the smallest longitudinal forces, slip is prevalent. This slip will not be against the ground for very small forces, but due to the tire being elastic.

It should be noted that slip within a certain interval will generate a maximum friction force for braking, see figure 2.5. The friction force will increase with added slip up to a point where it reaches a peak braking force [12]. The peak braking force is determined by the maximum tire-road friction in the longitudinal direction, which is a function of the maximum normalized longitudinal force [2]:

$$\mu_{x,max} = \max \frac{F_x}{F_z} \quad (2.2)$$

, where F_x is the longitudinal force and F_z the vertical load on the tire. A larger vertical load will result in a lower maximum coefficient of friction [12]. This will have an effect on heavy vehicles such as buses.

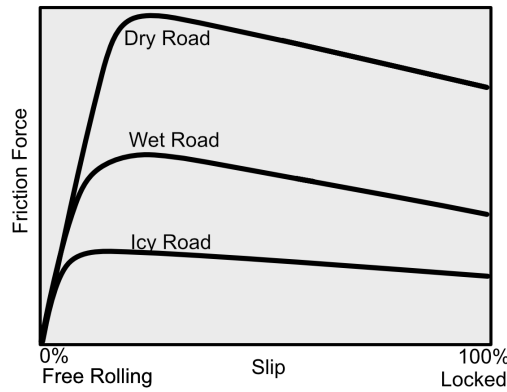

Figure 2.5: Graph of how braking is affected by tire slip, recreated from [12].

2.2.1.2 Lateral dynamics

When the tire is being pushed sideways, a lateral force will be imposed on the tire. Lateral forces can be generated during several different driving scenarios, such as cornering, driving on a cambered road or when affected by side winds. How the tires are able to generate traction forces in this direction is what will dictate the cornering performance and sideways stability of the vehicle. Sideways stability is especially important when considering driving over a road surface that will both move in the lateral direction, and have winds affecting the vehicle in the same direction.

If for example a wind gust in the lateral direction pushes the car to the side, the tire will point in a different direction compared to its resulting direction of travel. The angle between the direction of travel and where the tire is pointing towards is called the slip angle:

$$\alpha = \arctan \frac{v_y}{|v_x|} \tag{2.3}$$

, where v_x and v_y are the wheel's longitudinal and lateral velocity components, respectively.

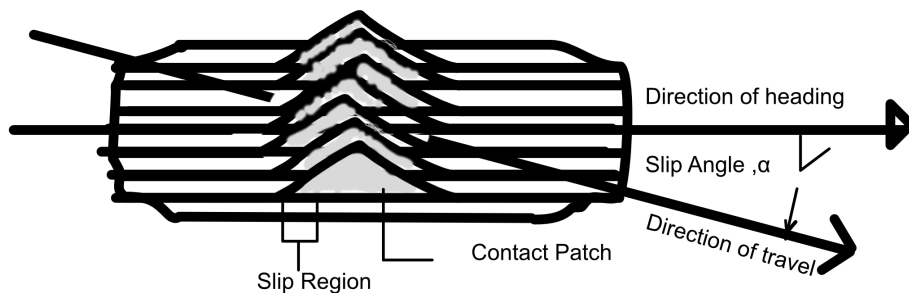

Figure 2.6: Illustration of how lateral slip deflects the tire and how the slip angle is defined, recreated from [12].

As with the tire's longitudinal force, the lateral force will increase in a linear fashion with added slip angle, until a peak force is reached [12]. If more slip is introduced

beyond this peak, one can expect the lateral tire force to decrease. This is shown in figure 2.7.

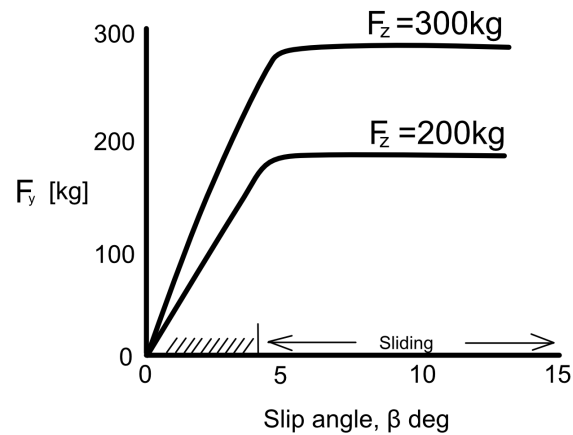

Figure 2.7: Effect of slip angle on lateral force, recreated from [12].

2.2.1.3 Magic Formula tire model

There are many mathematical models used for describing tire behaviour, one famous and widely used in industry being the MF, originally developed by Hans B. Pacejka.

The basic idea behind the MF model is to make a curve fit to empirical tire data using a trigonometric equation that can be manipulated with shape coefficients, see figure 2.8. Given inputs such as slip angle, slip ratio, camber and vertical load, the curve can then output lateral and longitudinal forces as well as aligning moments. Each force and moment has its own equation [10].

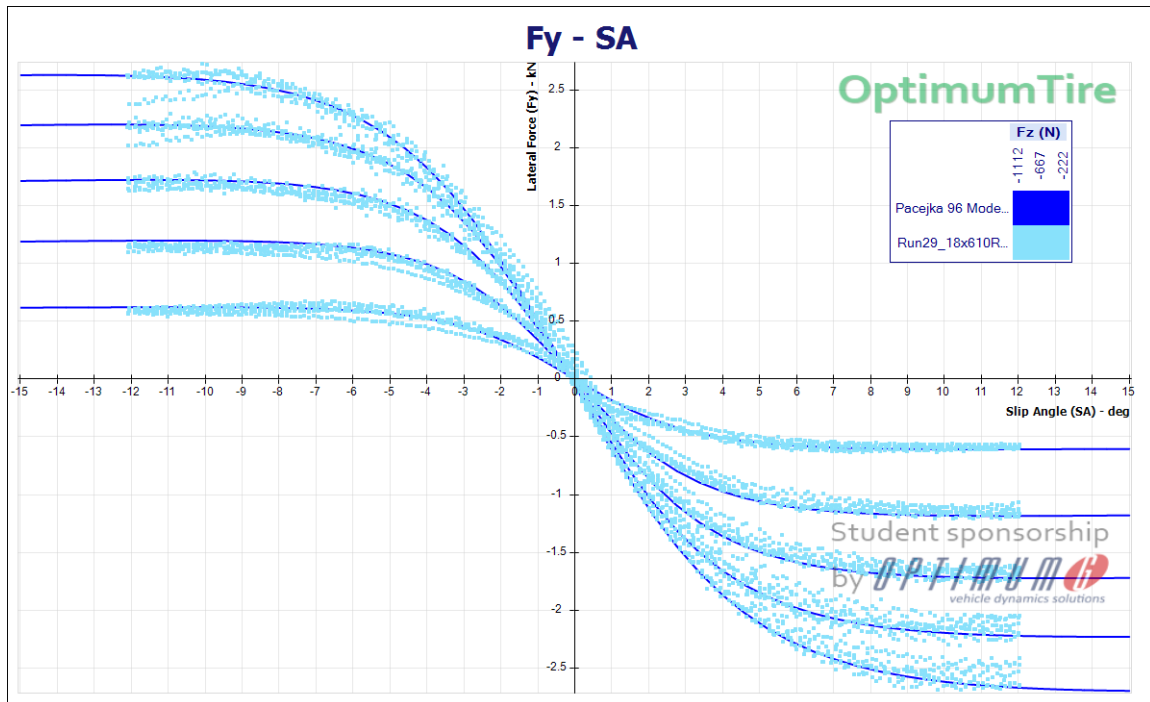

Figure 2.8: A Magic Formula curve fit of lateral force. Used with permission from K. Ivancic [21].

Even though Pacejka’s MF is widely used and basically an industry standard, there are some drawbacks. Because the model requires tire data from real world tests to yield accurate modeling of the tire behaviour, it can be hard if not impossible to model a tire properly without tests. A workaround is to acquire test data of a similar tire and vehicle setup, and then modify the curves to output expected tire behaviour. Note that the word expected in this context would imply a subjective assessment [9].

There have been several new versions made of the MF since its original release by Pacejka. The one used in this thesis project’s Simulink vehicle model is MF5.2, which has more parameters (such as inflation pressure) than for example Pacejka 89. But the basic idea is the same.

2.2.2 Suspension

Suspension systems are designed to ensure good tire-road contact at all times. Without proper contact, the normal force in the tire contact patch might not be adequate to generate satisfactory forces for braking, accelerating and cornering.

A conventional suspension system of a four-wheel vehicle is made up of the following components, see figure 2.9:

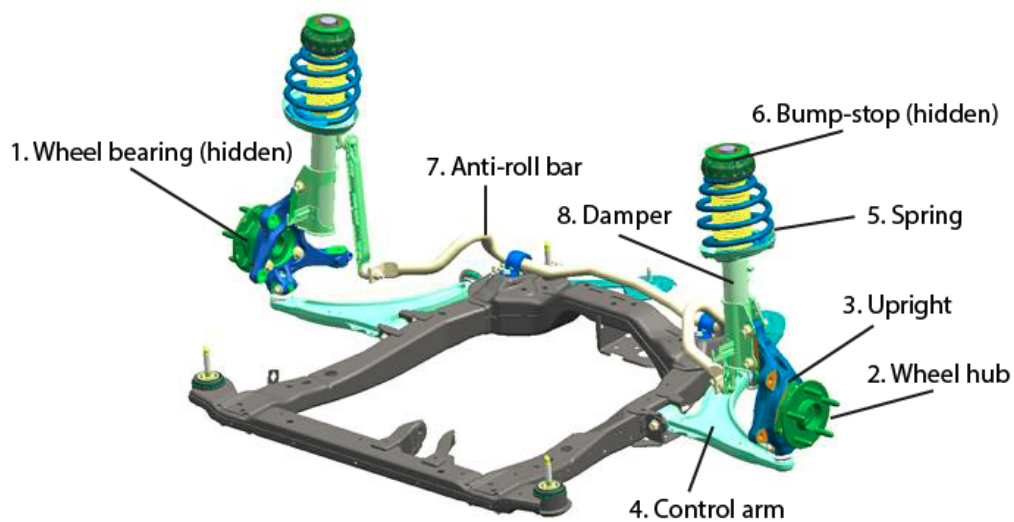

Figure 2.9: Overview of a MacPherson strut suspension system. Image used with permission from [15].

1. Wheel bearing
 - Allows for rotation of the wheel with minimal internal friction.
 - Must be dimensioned for right durability and stiffness properties.
2. Wheel hub
 - Attaches the wheel to the suspension system.
 - Houses the wheel bearing and mounts the brake disc.
3. Upright/Knuckle
 - Connects the wheel hub to the control arms.
 - Connects to the damper in case of a MacPherson strut.
4. Control arms
 - Hinged links that connect the wheel's upright to the chassis.
 - Constrains the degrees of freedom of the wheel.
5. Spring
 - Allows for vertical displacement of the wheel relative to the body.
 - Has a set preload to give an expected ride height and allow for extension.
 - Has a selected spring rate to suit targeted static performance.
 - Has a linear force-displacement relation.
6. Bumpstops
 - Provides a non-linear force generation in the end of the spring's compression stroke (see figure 2.10).
7. Anti-roll bar
 - Connects the left and right wheels and provides a stiffness to reduce body roll.
8. Damper
 - Dampens the spring movements and prevents oscillations.
 - Outputs reaction force as a function of velocity.
 - Tuned to yield targeted dynamic performance.

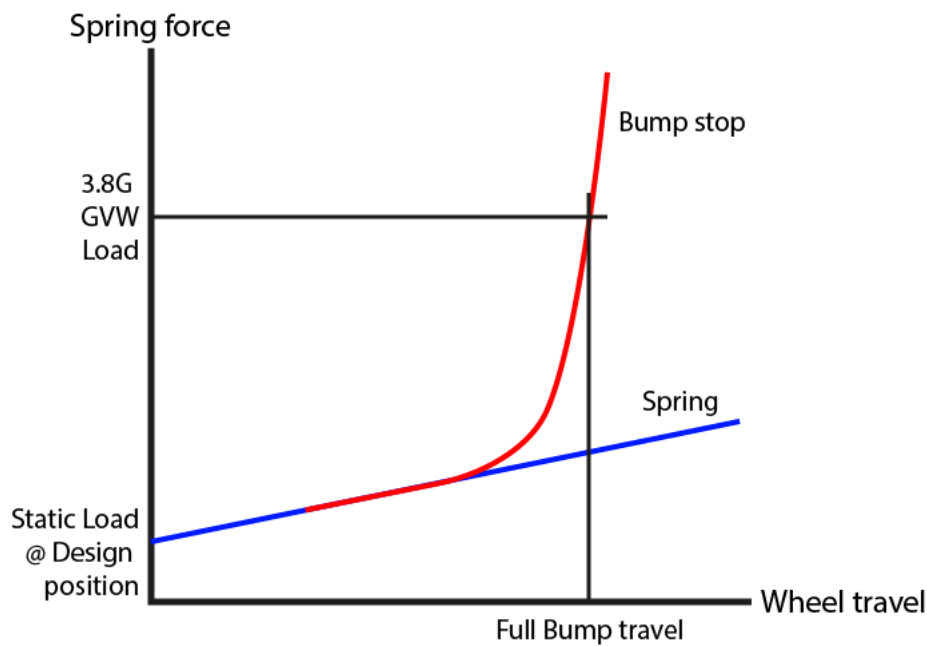

Figure 2.10: Force-displacement diagram of a spring with a bump-stop [15].

When designing a suspension system for a car, compromises are always a part of the equation. If a system was to be designed for a high-performance sports car, then emphasis would be put on maximizing cornering speed and responsiveness. This will usually result in a suspension which would not be ideal for any other vehicle type such as a family car, where ride comfort is usually of higher priority.

Design and setup compromises also have to be made when designing for a very specific case. A family car could very soft springs in order to filter out road imperfections, but would suffer in steering responsiveness, which is important when controlling the car during evasive maneuvers.

2.2.2.1 Steering effects

Due to a suspension system's geometry and elastokinematic (study of motion of elastic bodies) properties, the front wheels of a car are able to steer and generate lateral forces with steering input from the driver. This sequence of mechanical movements can also occur in the reverse order if the wheels are displaced vertically by a bump in the road, or if lateral tire forces are introduced.

Bump steer is when a vehicle runs over a bump with one of its axles which causes the wheels to be displaced either up or down. Due to the geometry of most independent suspension systems, a compression of the suspension will cause the front wheels to acquire a positive toe angle (wheels pointing towards the car center line) which causes steering effects [4]. This is reversed for the rear wheels, which will get a negative toe angle. During an extension of a wheel's suspension (if for example the car lifts), the reverse toe effects will occur for the front and rear wheels.

The steering effect described above is experienced for heave movements of the wheels, which is when both left and right wheels are displaced upwards in the same manner. This can also occur for roll movements of the suspension, which is when one side is under compression while the other is under extension. This will cause the compressed side of the front wheels (outer wheel when cornering) to produce toe in, while the extended side (inner wheel when cornering) to acquire toe out. This will also produce a steering effect, and can also happen when the vehicle rolls because of cross winds.

Lateral forces in the tire contact patch will also create steering effects due to the elastokinematics of the suspension. This mainly occurs in the control arm's rubber bushes, which will deflect differently because of different stiffnesses. This will in combination with the suspension hard point geometry cause the wheels to acquire a non-zero toe angle, and therefore make the vehicle steer. This is commonly referred to as compliance steer. These properties will usually give a car an under-steer tendency and is many times built-in by the manufacturer for safety reasons [8].

Steering effects such as bump steer will normally not happen in live axles (used in the rear) due to the wheel's directions being fixed perpendicularly.

2.2.2.2 Suspension types

There exists several different types of suspension systems and within each type many variations of geometries and spring and damper properties. Each suspension type has its advantages and disadvantages, and the type used will differ according to requirements.

One of the most basic system is a live axle setup. A live axle suspension system uses a rigid beam with each wheel mounted on either end of the beam. This suspension system is commonly used where high load-carrying capacity is required and can be found in heavy vehicles such as buses, but also in the rear of passenger cars. An image of a live axle is shown below in figure 2.11.



Figure 2.11: Image of a live axle.

A disadvantage is the lack of independent wheel movement, which is a result of the wheels connected to the axle being connected in a parallel line. This translates to any movement on one wheel is transmitted to the other, and can in the worst case force the other wheel off the ground. Because of the system's kinematics, and

ignoring the elasticity in the axle and joints, the two wheels will always have the same camber when cornering, see figure 2.12. A big advantage of utilizing a live axle is the lack of complexity, which boosts robustness, and the low cost. This causes many manufacturers to opt for this design.

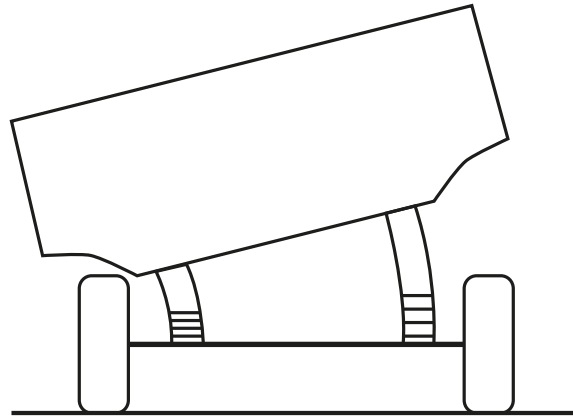
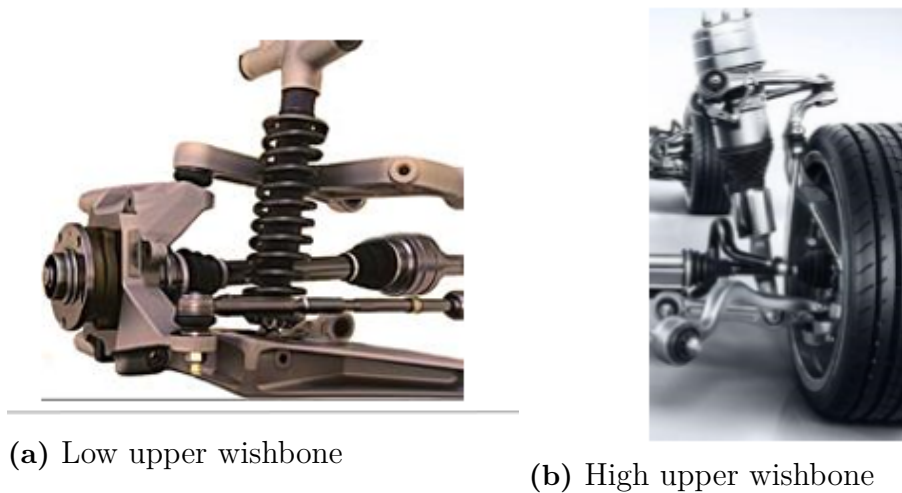

Figure 2.12: Illustration of a live axle under cornering.

When performance and a high level of adjustability is desired, a double wishbone suspension design is regularly adopted. The double wishbone suspension system uses two control arms (can be A or L-arms) to control the wheel. The system is classified as a independent system as each wheel can move independently, contrary to a solid axle. The system exists in both high or low upper wishbone configurations, see figure 2.13.



(a) Low upper wishbone

(b) High upper wishbone

Figure 2.13: Image of double wishbone setup.

This suspension system boasts many kinematic advantages over other designs and is therefore seen in cars with good handling properties. Its flexible design enables engineers to tweak parameters such as camber, caster and toe angles with ease. Additionally, because the wheels on either end of the car can move independently, tire contact is kept in one wheel when the other rides over a bump.

During cornering an independent system will maintain better tire contact compared to a live axle. In a corner, the independent linkage design will cause the inner wheel to have negative camber angle and the outside wheel a positive one, see figure 2.14. This is not optimal as larger lateral forces will be generated if the wheel's camber were more neutral and by that maximizing the contact patch area [1]. This is solved by setting the wheels to have more negative camber in static conditions, which the double-wishbone is able to do by having the upper control arm be shorter than the lower.

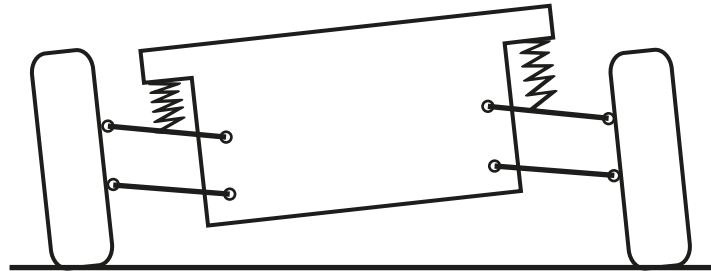

Figure 2.14: Illustration of a double-wishbone suspension under cornering (right turn).

The disadvantages of an independent suspension system such as double-wishbones is the added complexity which increases manufacturing costs. Additionally, good packaging of the suspension system can sometimes be hard to achieve, and might result in the body's inboard space being restricted. But this is a question of control arm size and position, and good packaging is therefore very much achievable.

2.2.3 Aerodynamic loads

Aerodynamic forces interact with the vehicle causing drag, lift, and lateral forces, which results in movements such as roll, pitch and yaw. Drag is the largest and most important force encountered by passenger cars at normal highway speed. The force decreases the maximum speed of the vehicle and increases the fuel consumption. Lift forces are also significant concerns in aerodynamics because of the influence they have on the vertical load and consequently vehicle stability [12].

Lateral wind will impose a side force on the vehicle and therefore might create a steering effect. In strong crosswinds, the side force could be greater than the drag force. With an increasing crosswind the driver's ability to hold the vehicle in lane could be influenced. This is because of the yawing and rolling moment. An increase in yaw will produce a larger slip angle and can result in oversteer or in worst case, a complete loss of control. The rolling moment will change the pressure distribution on the wheels and can cause the tires on one of the vehicle's sides to have reduced traction. In the worst case a large rolling moment can make the vehicle roll over.

Lateral force imposed on a vehicle body in crosswind is determined by:

$$F_S = \frac{1}{2} \rho v^2 C_S A \quad (2.4)$$

, where v is the total wind velocity, ρ the air density, C_S the lateral force coefficient and A the frontal area.

The moment of yaw and roll is determined by similar equations:

$$M_Y = \frac{1}{2}\rho v^2 C_{YM} A L \quad (2.5)$$

$$M_R = \frac{1}{2}\rho v^2 C_{RM} A L \quad (2.6)$$

, where L is the wheelbase, C_{YM} the yaw moment coefficient and C_{RM} the roll moment coefficient.

2.2.4 Heavy vehicles

Heavier vehicles such as trucks or buses have their CoG located higher compared to passenger cars, which makes them more unstable. Due to this, the roll-over typically occurs at lower lateral acceleration on a heavier vehicle compared to a passenger car. For a heavy vehicle with the CoG located further behind the mid-point between the axles. This will cause the heavier vehicle to have oversteer tendencies. For a passenger car it is more symmetrically distributed. Due to its larger mass the forces from impacting bumps are also higher than a car [14].

Larger vehicles with high flat sides are more sensitive to the effects of crosswind. Because of the large side area and location of the CoG, more yaw and roll moment will be generated compared to a passenger car [19].

In a research paper about crosswind performance of buses, a simulation in the MTS RPC Pro software was used for estimating the aerodynamic load on a bus exposed to natural crosswind gusts. The tire forces, driver input, wind velocity and vehicle response were measured on a real bus running on a road subjected to crosswind [16]. The results of the simulation is shown in figure 2.15.

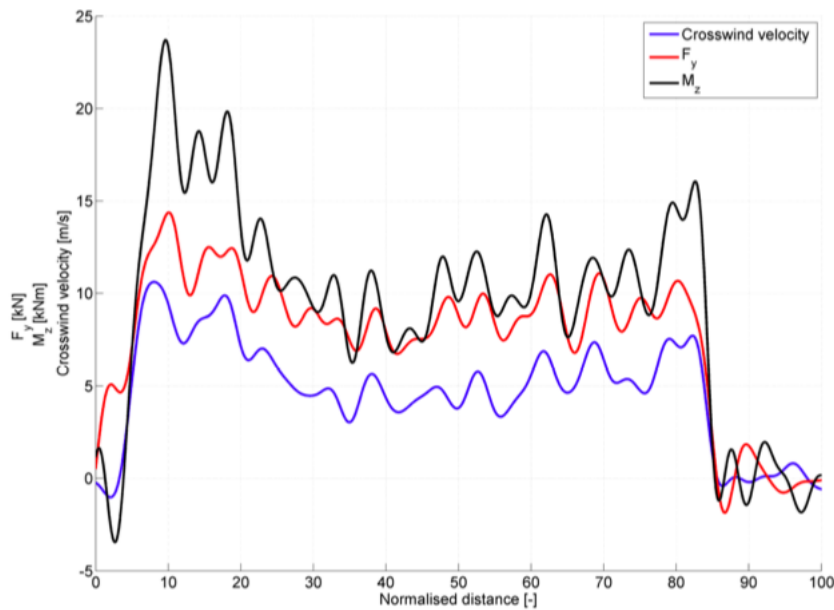

Figure 2.15: Estimation of the aerodynamic load on a bus exposed to natural crosswind [16].

In the figure, F_y represents the lateral force on the vehicle and M_y the yawing moment. The test can conclude that the yaw moment will increase more rapidly than the side force, and will also have a larger peak value. A more yaw-sensitive vehicle could be more difficult for a driver to control (due to oversteer being more difficult to correct than lateral deviation), compared to a larger side force sensitivity.

2.3 Vehicle on a moving road surface

To get a better understanding of how a vehicle is affected by a moving road surface, it is important to know the dynamics of the road itself. There are existing floating bridges of different configurations to study, but relevant knowledge can also be gained from other phenomenon such as earthquakes.

2.3.1 Dynamic conditions of a floating bridge

Due to the quite unique circumstances concerning Bjørnafjorden (the length, depth, and weather conditions), a well designed floating bridge is a viable option. This is due to the bridge design's ability to deal with the circumstances and handle the loads in a safe manner. This is something you engineer to do early on in the design process.

Most conventional bridges are designed to be able to accommodate some movement. Temperature, vehicle loads, and especially wind will impact the bridge, which engineers make sure the bridge withstands. The bridge deck is not meant to sway, rather move slowly due to the wind's direction and after the wind subsides move back to its original position without jeopardizing the structure's integrity. All these

changes in the bridge position will affect the vehicles driving over it [5, 20].

While traditional bridges affected by wind mostly generate lateral movement on the bridge, with some vertical motion, floating bridges will be affected by waves as well. Floating bridges use pontoons to float. The result of this is a much greater vertical motion on the bridge, affecting the vehicles upon it.

2.3.2 Existing floating bridge

The Evergreen Point Floating bridge is located in Medina, Washington, USA, east of downtown Seattle. It carries the Washington State Route 520 across Lake Washington, with a depth of 65 m. The bridge is owned and maintained by the Washington State Department of Transportation (WSDOT) and is 2,4 km long with six lanes, three on each side. The bridge was built to replace a previous floating bridge from 1963 and opened in April 2016. The bridge is used by 74 000 motorists everyday, which requires a certainty of safety and longevity [24].

When the planning of the project began engineers were certain that a floating bridge would be the most cost efficient and less difficult bridge to build because of the poor soil conditions of Lake Washington. The new bridge is supported with 77 pontoons and secured with 58 anchors to the bottom of the lake. It is resistant to winds up to 89 miles per hour and requires closure during extreme windstorms.

No documentation about how the bridge motion affects the vehicle or the driver while crossing the bridge is reported. Neither has there been a previous investigation about this subject before building the bridge.

2.3.3 Effects of earthquakes

A technical paper focusing on the *Lateral Stability of Vehicles Crossing a Bridge during an Earthquake* looks at a bridge using data from a real earthquake with a truck driving on it [11].

The report concludes that even without a reaction from the driver, with the vehicle moving at constant speed, the intense shaking of the bridge creates the critical conditions that may lead to rollover. Deceleration while moving on the bridge also affects the vehicle by decreasing the normal forces, and increasing the side-slip force, especially at higher velocities. The driver's in-phase and out-of-phase reaction is also mentioned to influence the tires normal forces as well as the side slip angle due to a change in steering wheel angle. The change in normal forces impacts the roll over stability, and the side slip angle will impact the lateral forces on the tires. These effects also increase with the velocity of the vehicle.

2.3.4 Motion data for floating bridge in Bjørnafjorden

The different weather and climate conditions are determined from a one-year and a 100-year storm. N-year storms are the worst storms that typically happens during N years. With this nomenclature, one-year and 100-year storms are identified as load cases. These load cases are generated from a FEM simulation on the bridge model. This lays the groundwork to the data used in this project. The waves in Bjørnafjorden cover a wide combinations of amplitudes, period range and directions. The global structure is screened to the applicable range of sea state spectra, regarding the main direction and peak periods [18]. The wind is applied perpendicular to the bridge axis, due to wind from other angles are seen as a decomposition of the load. These loads will result in motion on the bridge. The motion is measured around its rotational centre, shown in figure 2.16.

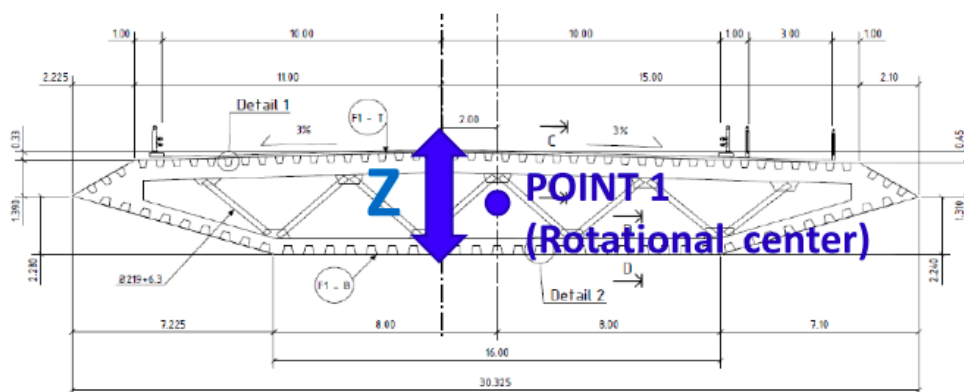

Figure 2.16: Visualization of the rotational center of the bridge [22].

The vertical displacement is then evaluated for different velocities driving across the bridge. This is shown in figure 2.17.

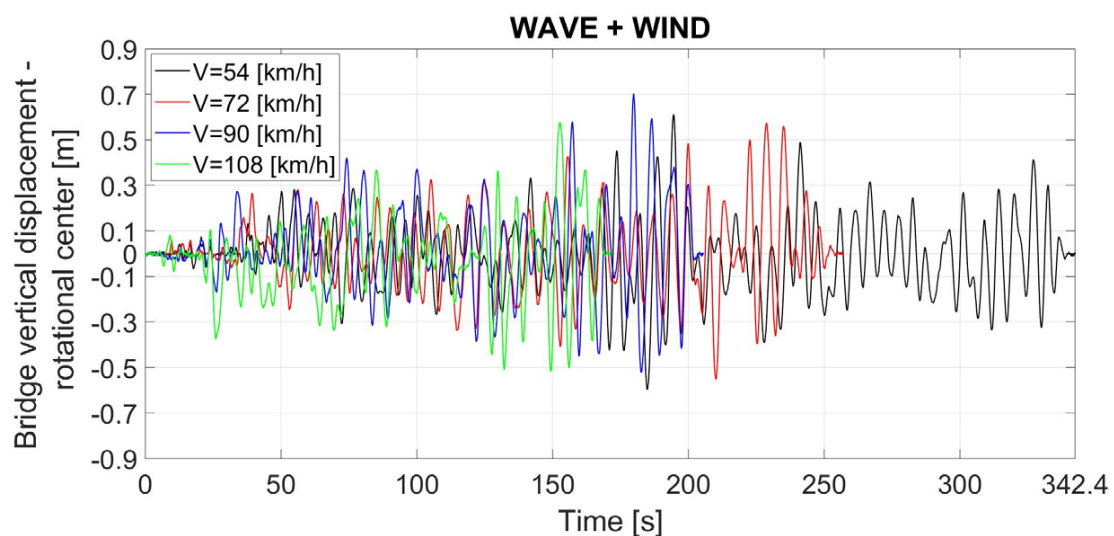

Figure 2.17: Vertical motion along the bridge due to wind and wave loads [22].

2.3.5 Simulator testing

"Driving simulators hold key advantages for identifying risks to driving safety among different driver populations and across driving conditions..." writes Campos JL et al. in their 2017 report *Guiding Framework for Driver Assessment Using Driving Simulators* [6]. The use of simulator testing in driver trials is increasing. A driver simulator can be used in different scenarios. It has the ability to test road safety conditions due to different weather conditions on regular drivers without risking damaging the driver or the vehicle. A simulator has the benefit of being able to store valid information about the test runs and compare it with subjective assessments. This is important for analyzing the credibility of the result of the driver and confirm it with telemetry data from the simulator itself [13].

A simulator is versatile and can be used in almost any scenario. One problem that arises with simulator trials, however, is that the simulation has to be as real-world like as possible, for example the test scenarios and the motion of the simulator itself. Therefore the fidelity of the simulation is important to consider and to perfect, although absolute fidelity will never be reached. As discussed in a thesis about model validation for a moving simulator [3], the model validity has to be within certain criteria, while also work with available computational power.

One factor to consider when working with simulator testing is that a lot of people experience motion sickness driving the simulator. A study that took place in Japan showed that 62,5 percent of the test drivers experienced motion sickness after using a simulator [23]. This can make a study difficult to perform.

3

Methods

This chapter will present the method and the proceedings of the project. In the beginning of the project the group decided to diverge into different sub-groups to utilize each members area of expertise. The method of the project is presented in figure 3.1.

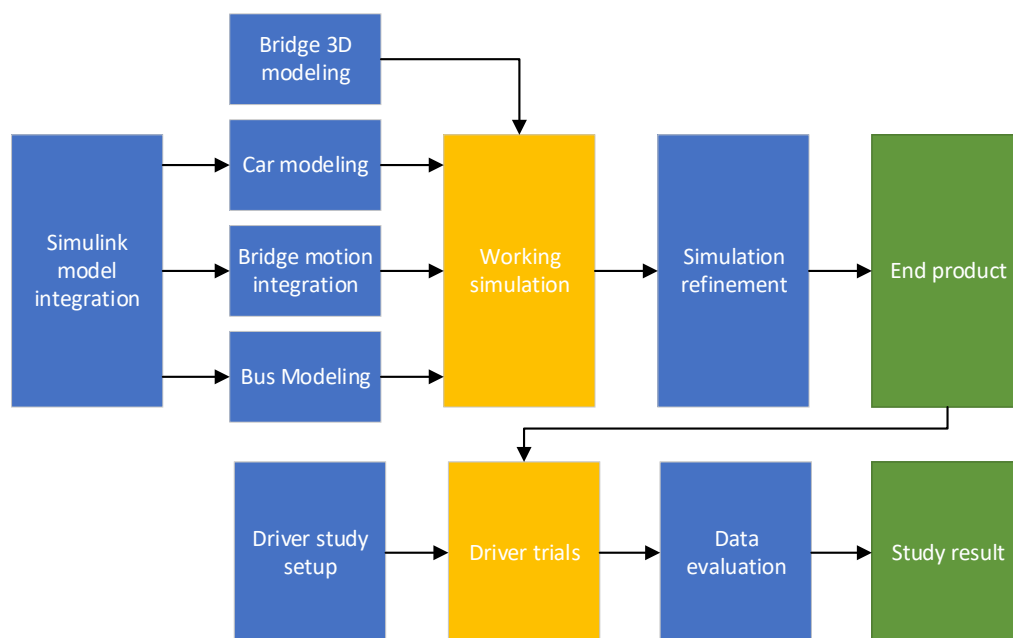

Figure 3.1: Overview of the project's workflow.

3.1 Vehicle modeling

A vehicle model of a generic passenger car is available with Cruden's Panthera software. The Simulink model is a complete representation of a car and all its sub-systems. This model was later used as the foundation for further vehicle modeling.

The Simulink model runs on Matlab 2015b and uses a combination of the Simscape Multibody toolbox, Simdriveline toolbox and TNO MF-Tire software, to represent the vehicle model. In order to integrate this into the simulator, Cruden's ePhyseNet toolbox was used. This toolbox acts as the layer between the simulator hardware and the vehicle model.

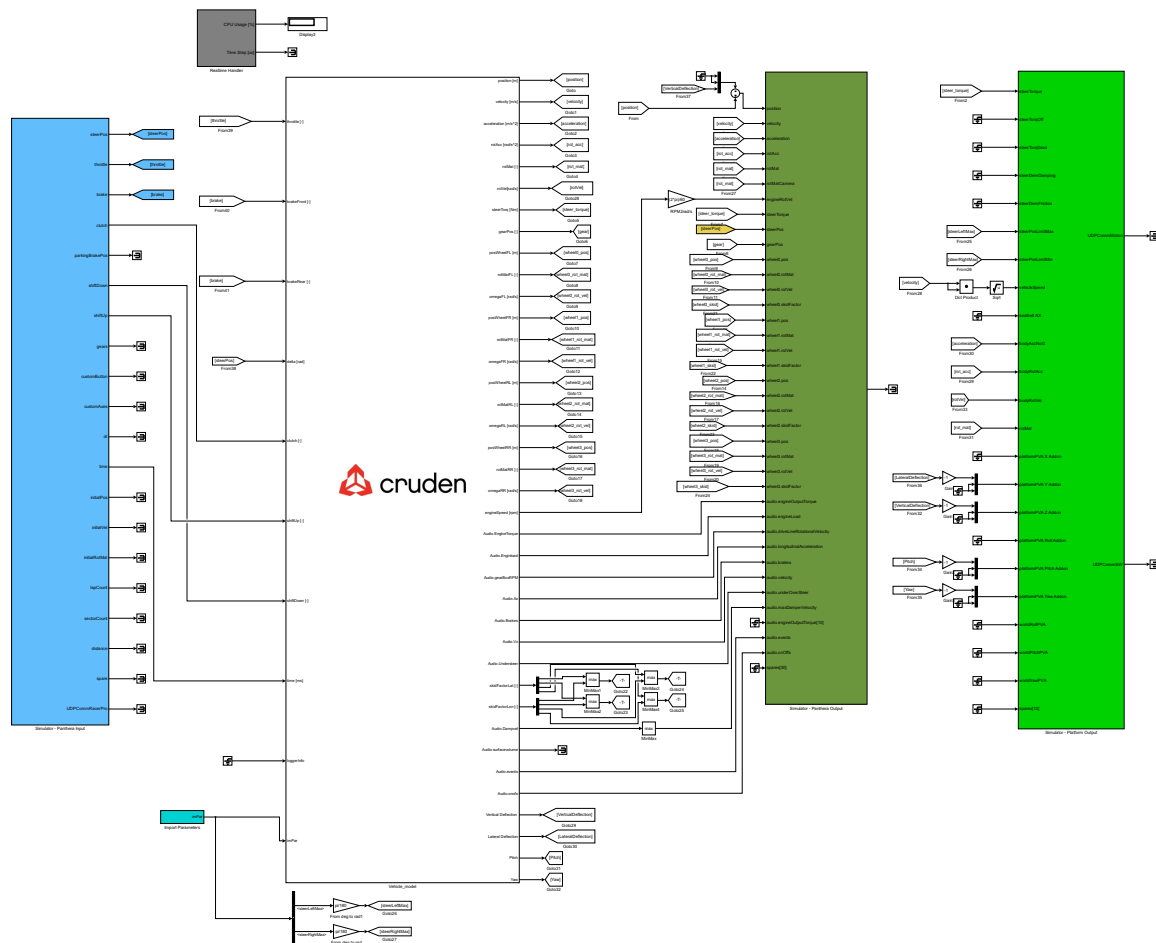

Figure 3.2: Top layer of the Simulink model.

In figure 3.2 the Simulink model’s top layer is shown. A larger illustration of this layer can be found in appendix A. The blocks shown are the ePhyseNet blocks as well as the vehicle model’s subsystem itself. The leftmost block receives the input values from the driver in the simulator (e.g. accelerating, braking or steering) and then sends them via Panthera to the Simulink model.

The second block (the white block) is the vehicle model that takes the input signals from the block beforehand and calculates the resulting vehicle behaviour. This is the block with all the subsystems, its physical modeling and attributes about the car. All the changes that had to be made to make the experience of driving the car as realistic as possible was made in this block.

The third block takes the calculated values from the vehicle model and sends them to Panthera, which controls the graphics and audio. The last block takes the calculated values from the vehicle model and sends them to the platform of the simulator, which outputs motion and steering torque. EPhyseNet also provides the ability to directly influence how the motion platform moves without going through the motion cueing model. This ability gives full control of the experience inside the simulator without

having to fully understand the under-laying parameters of the cueing software. This is important because the cueing model filters out low accelerations and small movements in order to keep the platform close to its resting position and ready for big movements. Without the motion addons, the platform's movements was assessed to be an under-representation of the real-life vehicle movements that one would expect.

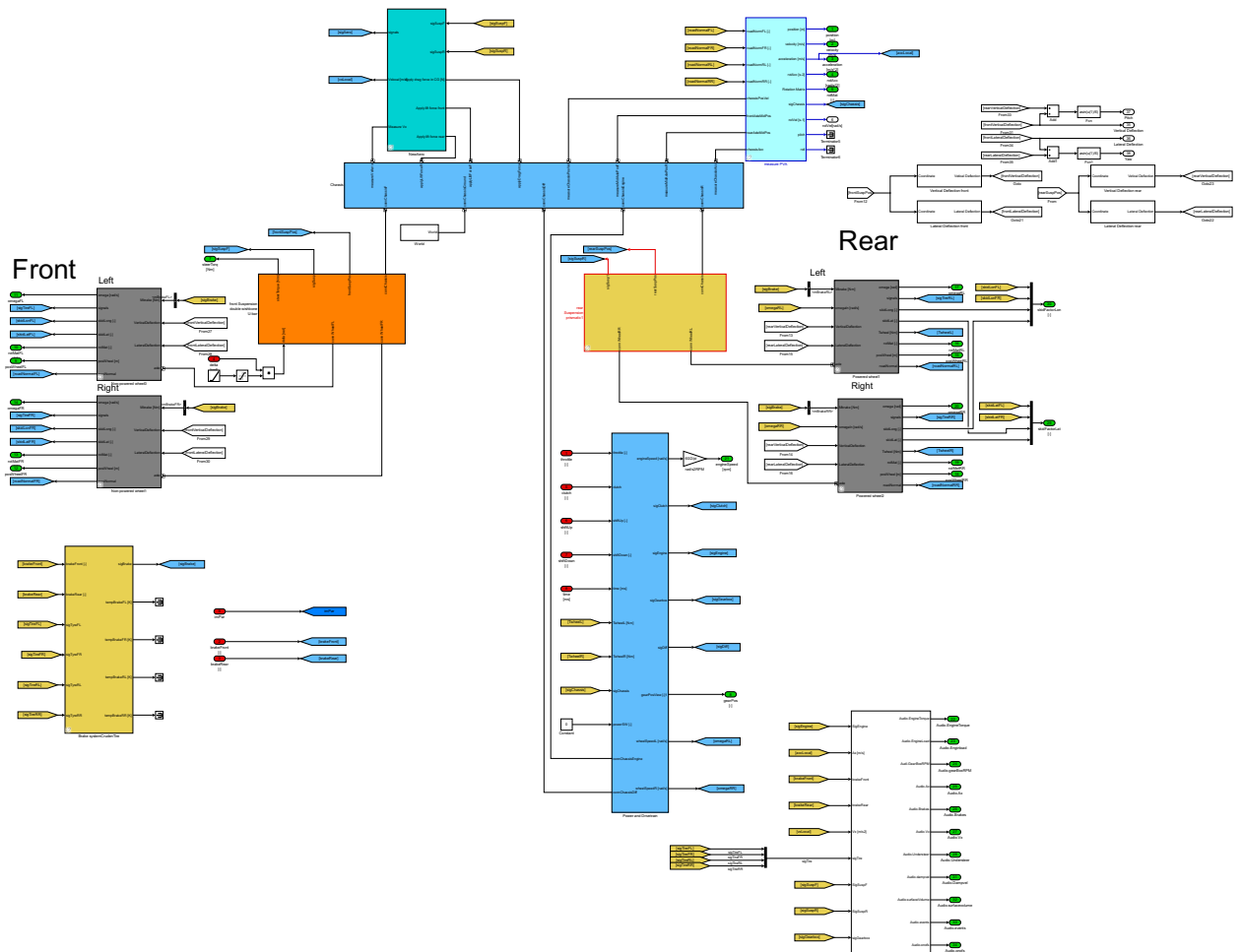

Figure 3.3: The vehicle model block.

The vehicle model, shown in figure 3.3, is composed of several different blocks. All the blocks combined represents a passenger car. Cruden's vehicle model had a lot of existing problems that needed to be solved before the model could function in the simulator. Most of these problems were related to a different version of ePhyseNet in the unmodified model and the ePhyseNet version used at Caster.

One unorthodox addition to the visual representation is the subtraction of the vertical movement of the car from the view. This had to be done in order to keep the vehicle on the bridge surface since the graphical model is fixed in space and cannot move. Without this addition the car moved far below and above the road surface during the load cases.

3.1.1 Car model

The main issue for the model of the passenger car was the tires. The tire model was tweaked to feel as a more representative experience of a real-world car's handling. At first the tires did not generate large enough lateral and longitudinal forces. To fix these problems the tire scaling factors in Magic Formula were changed. To solve the problem of the tires not being able to generate sufficient lateral forces, the scaling factor for the lateral peak friction coefficient was increased. The car was able to accelerate, but hard braking resulted in the tires saturating. This was solved by limiting the maximum brake pressure with a saturation block and thus preventing forces the tire model cannot handle.

3.1.2 Bus model

With the knowledge gained from modeling the passenger car, a heavier and more unstable vehicle in the shape of a bus was developed. Changes to the values and parameters was matched with parameters from several different tourist buses due to specific bus models not having a complete technical data sheet publicly available. These parameters can be found in appendix B.

The bus model is a heavily modified version of the car model to more accurately simulate a bus. The most prominent changes had to do with the suspension and tire model. The suspension now only uses Simscape Multibody springs and dampers, and a visualization can be found in figure 3.4. All bump stops have been removed and all springs are linear. This simplification was done to save time and make modeling easier. If the compression of the spring is large enough the simulated spring will not generate forces equivalent to the one in a real bus and could result in an inaccurate simulation.

The rear suspension was changed from a double wishbone to a live axle and the front geometry was modeled after an independent suspension available from an OEM with some minor assumptions and simplifications. The tire model was changed as well. While MF is still used, the actual computational blocks had to be changed, since the ones from the car saturated at 15 kN vertical load made it impossible to have a 18 000 kg bus with 4 tires.

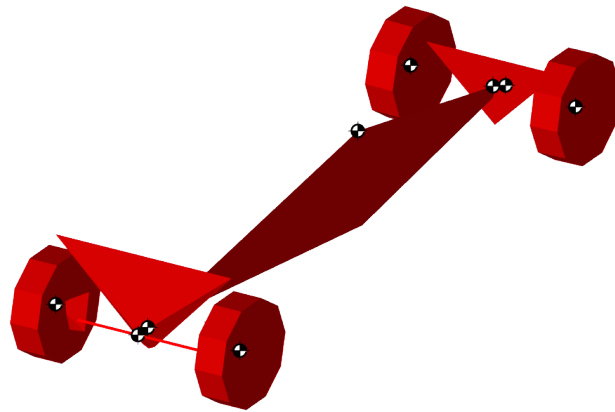

Figure 3.4: The Simscape Multibody representation of the bus.

Other changes include, but are not limited to, changes to the engine, torque, clutch, gear ratios, throttle mapping, aerodynamics, rev limiter, torque curve and brakes.

The inertia of the bus was simplified and calculated using CAD software as a cuboid with the axis of rotation set in the region of where the roll, yaw and pitch axes of the bus body should be. The mass of the cuboid was set to 1 kg to make it easy to scale it to the mass of the bus.

3.2 Wind and wave data

The wind and wave data received from NPRA was represented as a space-time matrix, where the data points were spaced with 1 meter along the bridge totaling 5138 m and at 0,2 second intervals. This discrete data had to be input as a continuous value with a continuous second derivative, in order to have the acceleration of the bridge correctly modeled. This was at first done in the Simulink model using a 2D-lookup table using bicubic interpolation. It was quickly established that this implementation was a no-go since the performance was too low. Therefore a new implementation had to be found, and came in the form of a C++ MEX function using ALGLIB for the interpolation. The final implementation is shown in figure 3.5. Using C++ instead of Matlab made it possible to keep soft real time while simultaneously using a step size of 0,001 seconds.

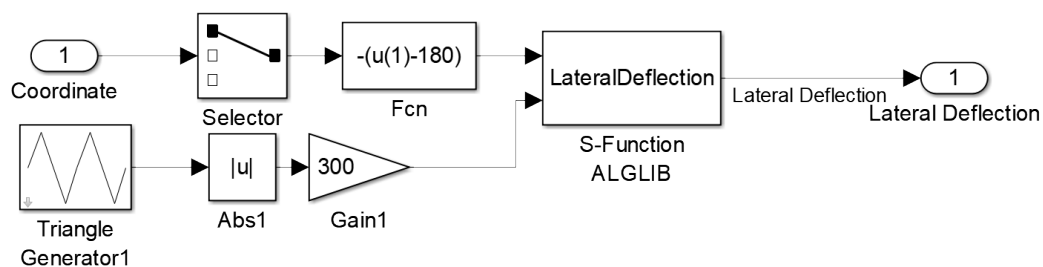

Figure 3.5: Subsystem for acquiring lateral deflection.

3. Methods

In order to keep the RAM requirement reasonable, the data used at any given time in the simulation is only 300 seconds. This results in the following $300 \cdot 5 \cdot 5138 \cdot 8$ bytes of data, which is around 54 million bytes or 54 MB, instead of around 700 MB for the whole data set.

Bridge movements is directly added to the road surface in the Simulink model and from there the MF-tire model handles the subsequently generated forces. This makes modeling easier as no further additions has to be done to get the model working. The road surface position is the sum of the graphical bridge model and the bridge movement.

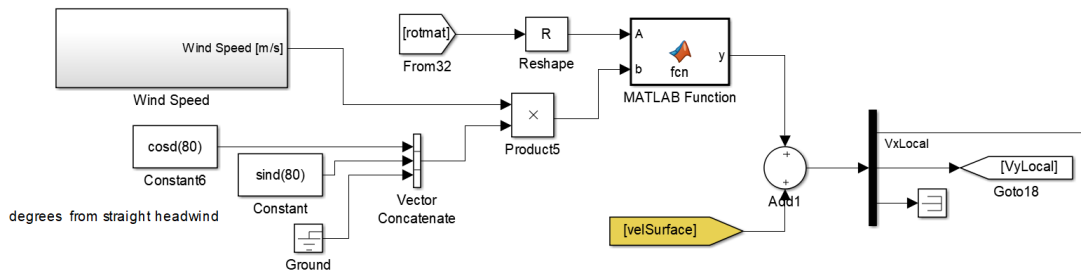

Figure 3.6: System for calculating the wind speed relative to the vehicle.

Wind speed is calculated from a given direction in world-coordinates and then using the rotation matrix of the vehicle to translate it into vehicle coordinates. Now with the wind speed known in vehicle-coordinates, it is summed with the vehicle speed, see figure 3.6. The final step is calculating the drag forces generated with equation 2.4, then applied in the center of pressure.

3.3 Graphical environment model

A graphical model of the bridge was developed to be used as the driving environment in the simulation. The model of the bridge was received from NPRA and then modified to enable implementation in Panthera. For 3D modeling the software 3ds Max from Autodesk was used. The model was then imported into Cruden's Track Editor software for conversion into Panthera. Textures for the model were created in Adobe Photoshop.

The original bridge model had to be simplified by reducing the number of polygons to improve the graphical performance in Panthera. This was done by using modifiers such as ProOptimizer in 3ds Max, as well as outright removing unnecessary polygons. Panthera only allows a maximum of around 21 thousand triangles per object and because of this, the model had to be divided into several objects to uphold a high level of detail. For example all supports and pontoons were split into individual objects and the road was divided into 13 objects.

The mesh was then further modified by converting triangular polygons into quads. This was only done for the road sections of the bridge model as they had to be texture mapped, which the use of quads greatly simplifies. When this was done, the road sections were ready for UV mapping. For this, the modifier Unwrap UVW was used, which unfolds a object along specified polygon edges. This resulted in an unfolded view of the road section which was then exported as a Targa raster file and then imported into Photoshop. Textures were added on the road surface in form of two lanes in each direction of travel to make the driving easier and more realistic for the driver. One lane in the driving direction was measured to be 3,75 m.

Lastly, the surrounding terrain in Bjørnafjorden was added, shown in figure 3.7. The 3D model for this was acquired from NPRA and was based on terrain topology data. Road signs was designed and incorporated in the model.

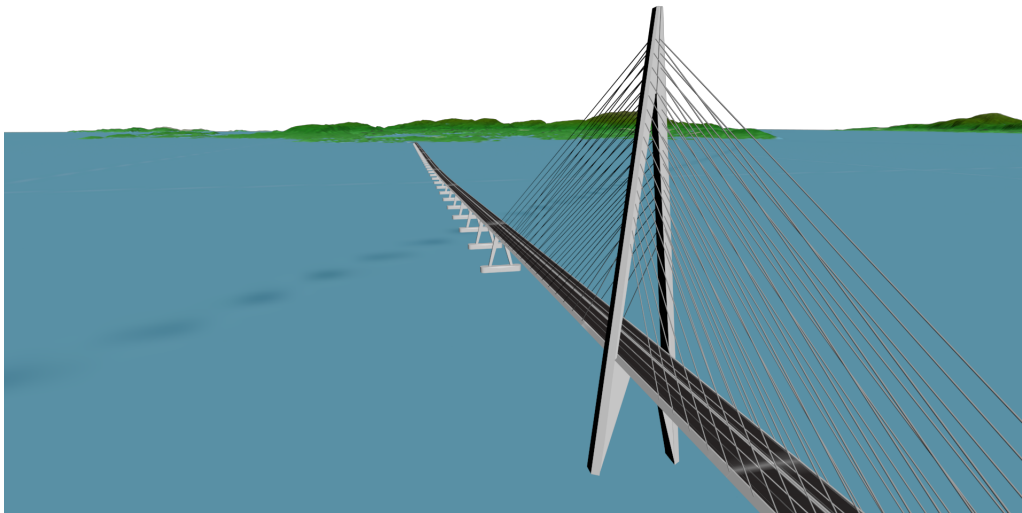

Figure 3.7: Rendering of the driving environment in 3ds Max.

3.4 Driving trials

When the simulation was working properly, driving trials were carried out to evaluate the experience driving on the bridge and how well the vehicle model of the car and the bus was performing. The project chose to use test drivers with previous experience from driving Caster's simulator. This was due to the learning curve of the simulator as well as the risk of motion sickness, described in section 2.3.5. Evaluating the driving experience of new drivers would be more difficult and perhaps yield unreliable results. It has been observed that some new drivers do not handle the simulator in the same way as driving a car in real life. Experienced drivers has more knowledge about how it will behave in different scenarios.

The trial consisted of 3 scenarios, with the first being without any bridge motion or wind added on the vehicle, what will be referred to as scenario 0. The latter two scenarios added different storms to try and simulate different conditions, one for the one-year-storm and one for the 100-year-storm, respectively. The participants answered a questionnaire after scenario 1 and 2, where they were asked to compare their experience of these scenarios to scenario 0. These scenarios were carried out for the car and the bus model. When all the different scenarios were finished, the test driver also answered an overall questionnaire about the experience. The questionnaires can be found in appendix C.

The trial of the car had the setup that for each scenario the test driver was asked to accelerate up to 80 km/h at the beginning of the bridge and keep this speed for 1 800 m. When they at this point passed two speed signs they would accelerate up to 110 km/h. They would then travel at this speed until they reached 2 600 m, where a new road sign would appear at their right side. At this point they were asked to simulate an over take. This consisted of the driver changing lane, accelerated and changing back to the original lane after reaching another road sign, this time on their left side. After this, they were asked to keep 110 km/h until the end of the bridge where two speed signs reappeared. At this point they were asked to release the accelerator and slow down the vehicle before the simulation was terminated.

The trial of the bus had the setup that for each scenario the test driver was asked to keep full speed on the third gear over the entire bridge. This was due to the tire model not being fully functioning. They were also asked to illustrate an over take at the same place as for the car, but for this model without acceleration. When reaching the end of the bridge and passing the two speed sign they were asked to release the accelerator and slow down the vehicle before the simulation was terminated.

The trials were supervised by the project group to analyze different behaviours displayed by the participants. In addition to gathering data through the questionnaires, telemetry data of the vehicle was collected to judge the overall driving dynamics. Panthera output a file that was read into Matlab to produce figures of different measures.

4

Results

In this chapter, the results of the trials are analyzed to evaluate the vehicle models in different driving conditions. After scenario 1 and 2 for each trial of the car and bus model, a questionnaire was answered by the test driver. All the results from the questionnaires are presented in appendix D. Additionally, telemetry data from the simulator was collected after each scenario. The figures of the relevant measures will also be presented in this chapter. For these figures, it is important to focus on the amplitude of the curves rather than their absolute positions.

4.1 Test method

The telemetry data from the driving trials are processed to show if the vehicle models work satisfactory. This is done with statistical measures, frequency analysis, and correlation with the questionnaire.

In figure 4.1, the mean RMS values and the mean variance for the steering angle is shown for both the car and bus model, which correlated to the data presented in this chapter. More movement on the bridge results in more counter steering, which implies it to be more difficult to handle the vehicle for the driver.

4. Results

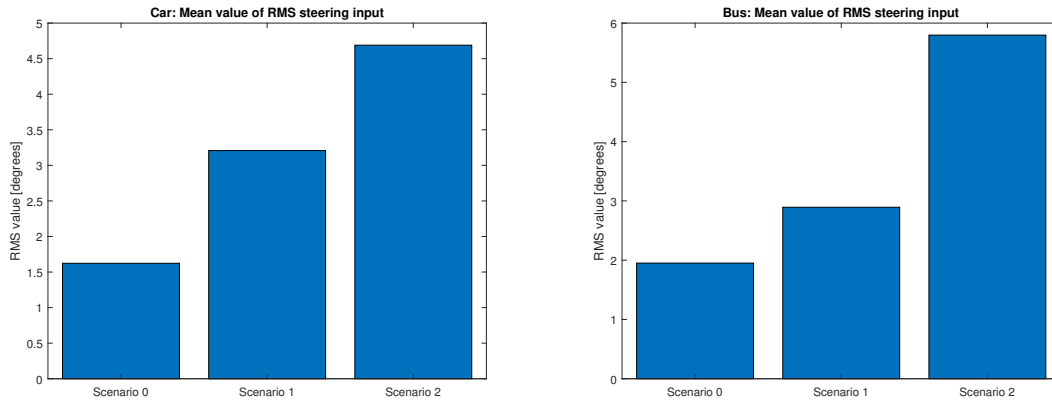

(a) Car, mean RMS steering input.

(b) Bus, mean RMS steering input.

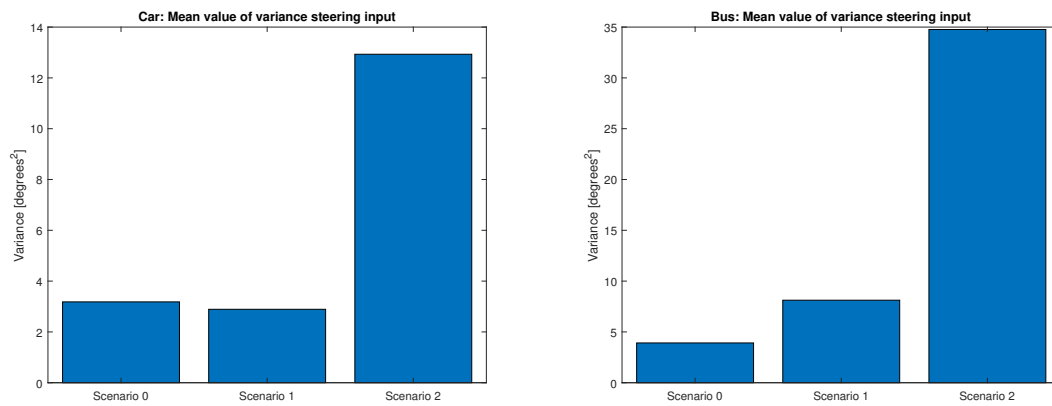

(c) Car, mean variance of steering input. (d) Bus, mean variance of steering input.

Figure 4.1: Measured mean values for steering input intensity.

Neither vehicle models have been validated against real vehicles or driving scenarios to verify the accuracy of the model. This is because no such measured data exist or previous similar studies have been found.

4.2 Results from driving the passenger car

In the section below, results to describe the difficulty of staying in lane and the ride comfort while driving the car model is presented.

4.2.1 Staying in lane

All but one test driver expressed it to be the same difficulty or harder to stay in lane when driving the car in scenario 1, see figure 4.2. This is to be expected as external forces from the bridge movements and wind are applied to the vehicle body. One participant in particular, test driver 7, answered in the questionnaire that it was easier to stay in lane in scenario 1 compared to scenario 0. When examining the root-mean-square value (RMS) of the steering input between scenarios 0 and 1, all the drivers had a higher value in scenario 1, see table 4.1.

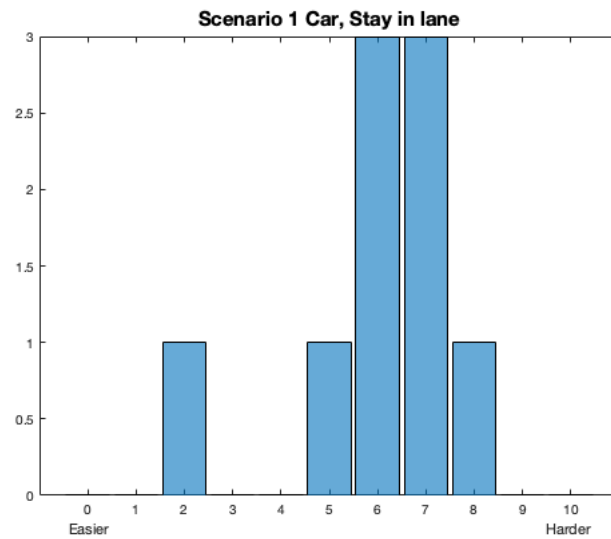

Figure 4.2: Result from questionnaire: Scenario 1, stay in lane.

Table 4.1: RMS of Steering input on car.

Driver	Scenario 0	Scenario 1	Scenario 2
1	0.916	3.113	4.868
2	1.320	3.387	4.955
3	1.296	3.093	4.616
4	0.849	3.074	4.639
5	1.519	3.123	5.541
6	1.274	3.116	4.538
7	2.824	3.480	4.383
8	3.097	3.176	4.664
9	1.512	3.309	4.001

4 out of 9 people expressed it to be easier to stay in lane in scenario 2 compared to scenario 0, see figure 4.3. This is a higher number of people compared to the answer of scenario 1, which is interesting when considering the higher storm intensity. It would be expected that this scenario would be more difficult to drive in than scenario 0 or scenario 1. This pattern of counter intuitive answers could be due to the rating scale changing directions between questions. For example, the question before "Stay in lane" had a scale of worse to better, while this question used easier to harder (i.e. a change from negative-positive to positive-negative).

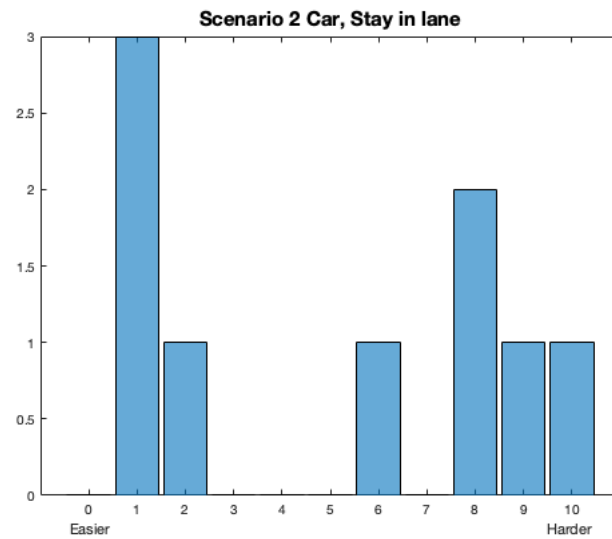

Figure 4.3: Result from questionnaire: Scenario 2, stay in lane.

When examining one of these outliers, test driver 3, the telemetry data from the simulator run shows a higher amplitude in the amount of steering input in scenario 2 compared to 0, see figure 4.4, and is also shown in the RMS values, see table 4.1. This would imply that the driver was under a higher workload in scenario 2 compared to scenario 0. The question that could be asked from this is whether this person's answers in the questionnaire needs to be further analyzed. This claim is also supported in the graph showing the car's positions between the scenarios, where scenario 2 showed larger deviations than scenario 0, see figure 4.5.

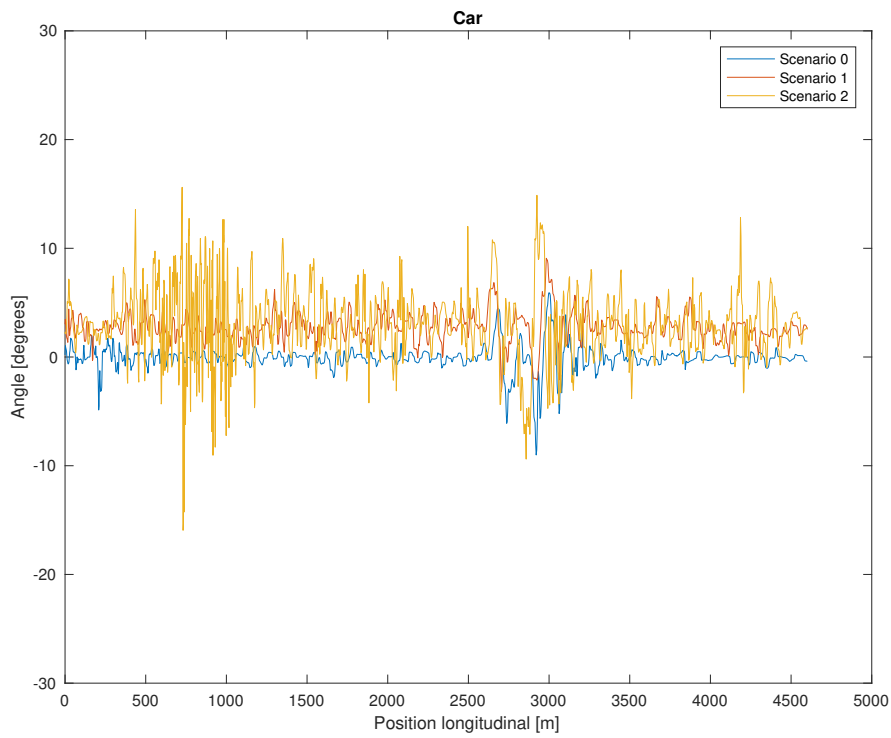

Figure 4.4: Data from test driver 3: Steering angle, lane change at 2600 m.

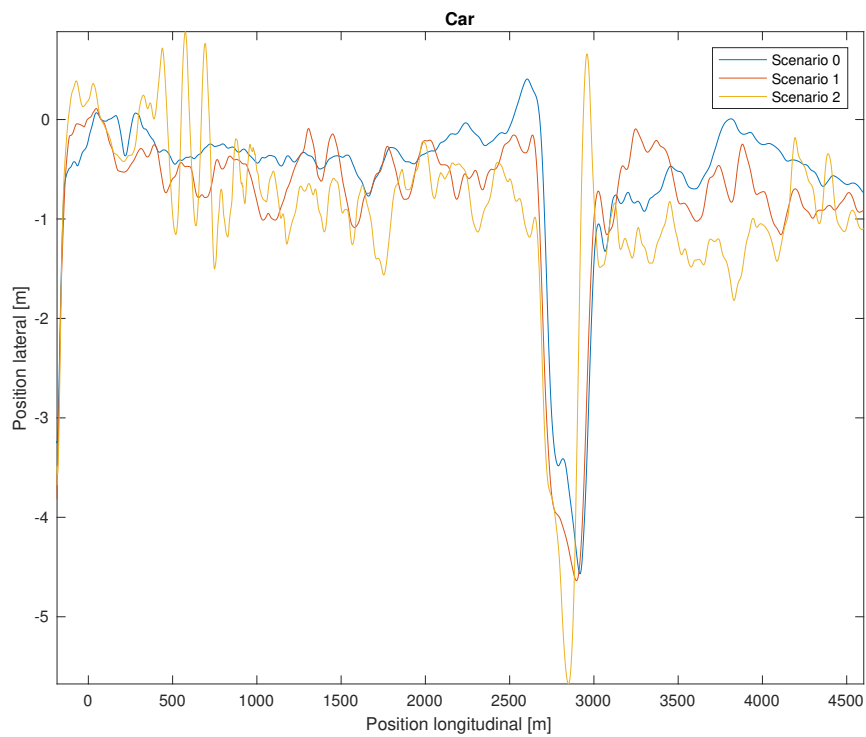

Figure 4.5: Data from test driver 3: Position of the car, lane change at 2600 m.

4. Results

A FFT analysis was performed on the steering angle data. By doing this, the project gained knowledge about what frequencies the driver has to do steering corrections at. In figure 4.7, this is presented for the car. As previously stated about the drivers workload, scenario 2 requires both more and quicker responses. When analysing the frequency contents of bridge motion, see figure 4.6, a correlation between the frequency of steering correction and bridge motion can be observed.

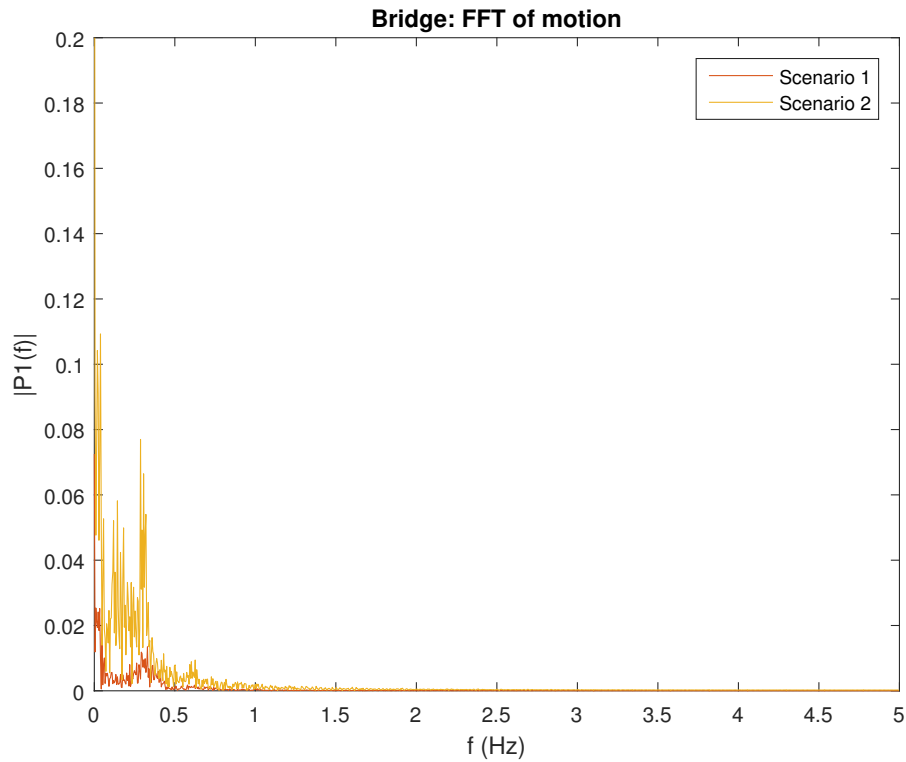

Figure 4.6: FFT analysis of bridge motion, $v=79$ km/h.

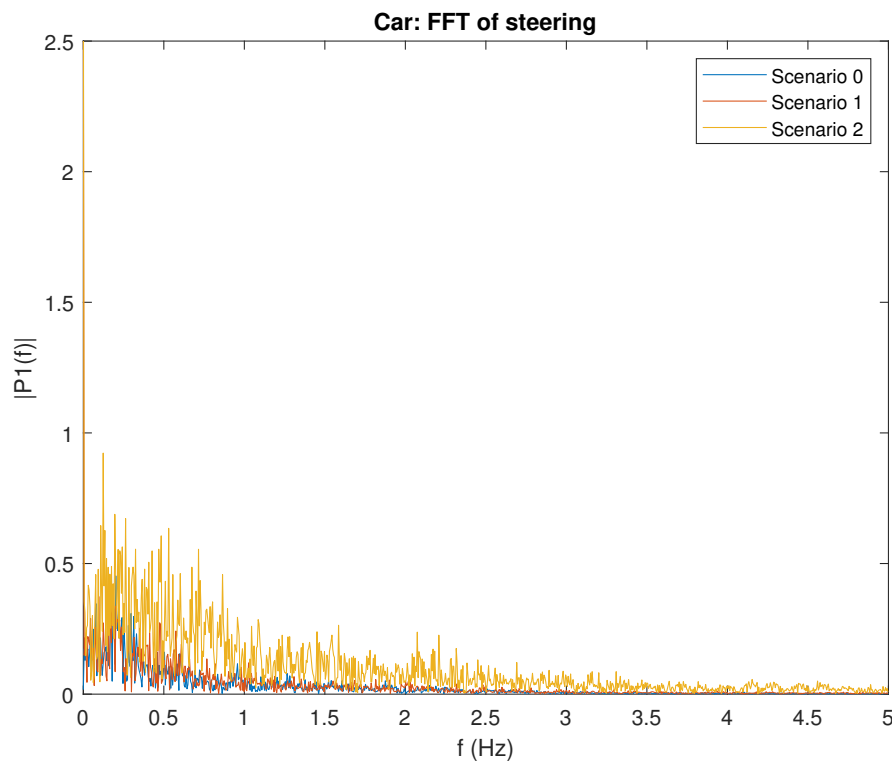
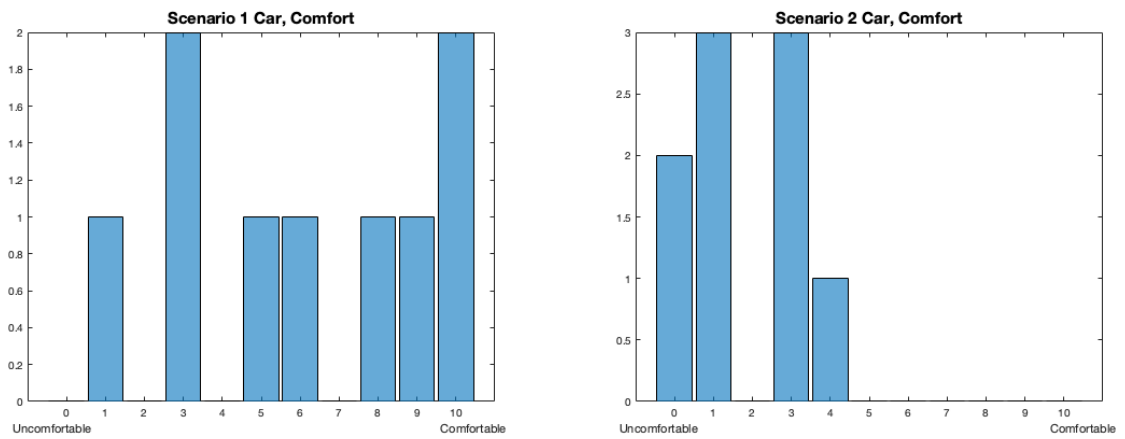

Figure 4.7: Data from test driver 3: FFT of steering angle.

4.2.2 Comfort

The answers from the questionnaire covering the comfort of driving in scenario 1 were very scattered. This might have been caused by the question being not clearly phrased and therefore misleading for the participants. Some people said it was an unpleasant experience while others thought it felt as an ordinary driving experience in the simulator. For scenario 2 the opinions were more united, namely that it was a much worse scenario than scenario 0. The result of the questionnaire is presented in figure 4.8.

4. Results



(a) Scenario 1.

(b) Scenario 2.

Figure 4.8: Result from questionnaire: Comfort.

In figure 4.9, the vertical acceleration is presented. This shows that the driver was experiencing a lot of movement in the simulator in scenario 2. Because of the storm intensity in this scenario the vehicle's suspension in the vehicle model bottomed out and made the simulator bounce a lot. This could affect the drivers perception of the experience and therefore skew the result of this topic and the one shown in figure 4.10. It is unknown if this event would happen in real life.

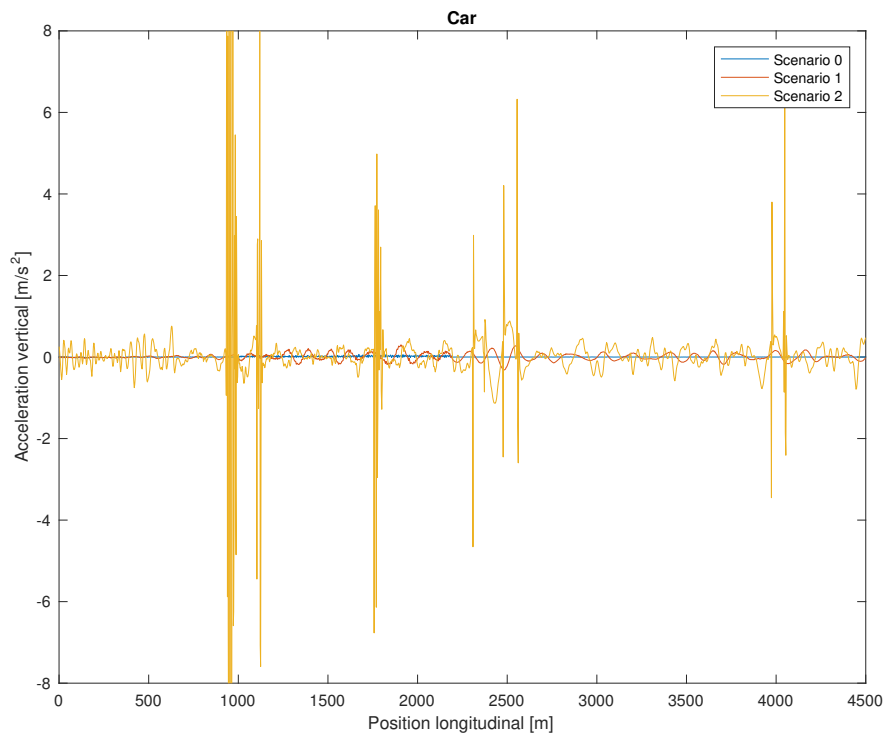
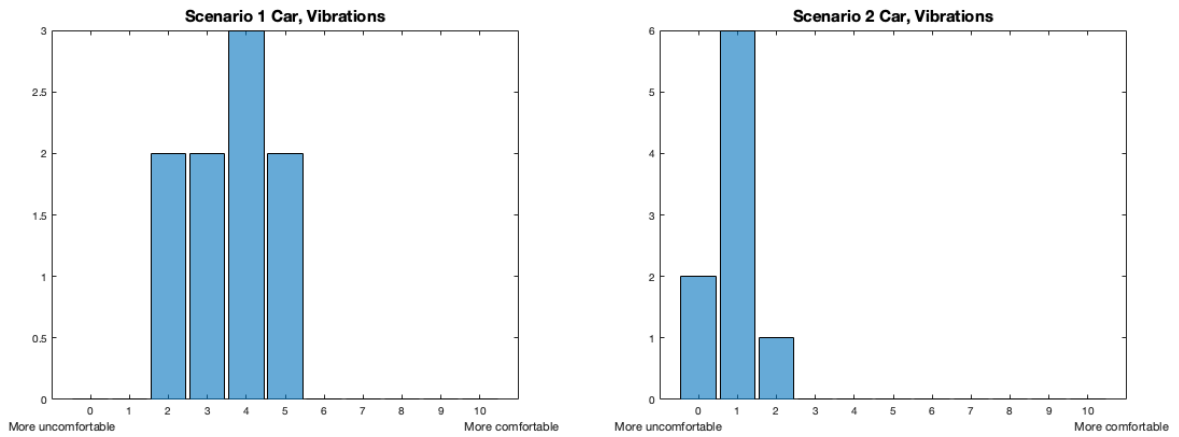

Figure 4.9: Data from test driver 1: Vertical acceleration.



(a) Scenario 1.

(b) Scenario 2.

Figure 4.10: Result from questionnaire: Vibrations.

4.3 Results from driving the bus

In the section below, results to describe the difficulty of staying in lane and the comfort while driving the bus model is presented. It is important to take in consideration that for this model the test drivers were not experienced bus drivers, and that this might affect the results.

4.3.1 Staying in lane

All collected data from the bus trials are showing that it is harder to stay in lane in scenario 1 and 2 compared to scenario 0. Scenario 2 was also a lot harder than scenario 1, shown in figure 4.11 and 4.12.

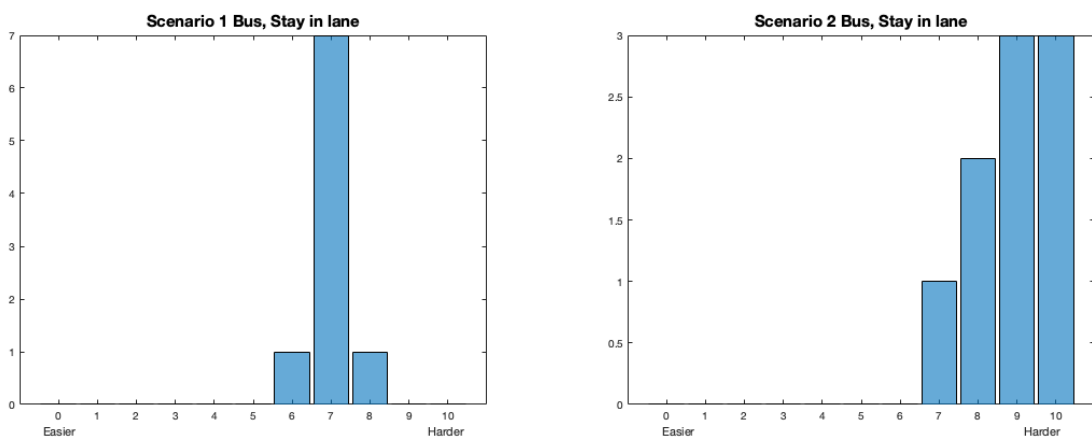

(a) Scenario 1.

(b) Scenario 2.

Figure 4.11: Result from questionnaire: Stay in lane.

4. Results

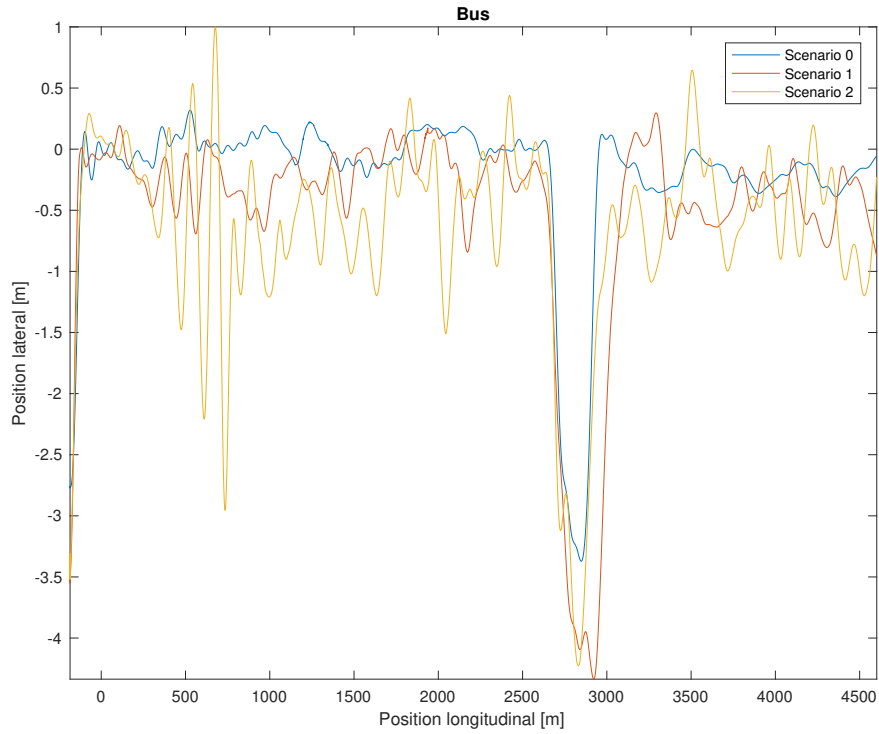

Figure 4.12: Data from test driver 3: Position of the bus, lane change at 2600 m.

The results is also showing that more steering input is needed for a higher storm intensity, see table 4.2 and figure 4.13. Test driver 7 is an exception, which has a higher RMS of steering input for scenario 0 than scenario 1. An explanation for these numbers is that the test driver tested the response of steering input in the beginning of the test run, see figure 4.14. Comparing the data from the position, see figure 4.15, of test driver 7 shows that the driver did deviate more in scenario 1 than in scenario 0. Therefore the RMS steering values is not representative of the true behavior of test driver 7.

Table 4.2: RMS of Steering input on bus.

Driver	Scenario 0	Scenario 1	Scenario 2
1	1.578	2.510	7.162
2	2.862	4.013	5.893
3	1.949	2.329	3.480
4	1.507	2.403	4.601
5	1.789	3.168	8.138
6	1.471	3.967	7.204
7	3.075	2.625	5.492
8	1.449	2.555	5.223
9	1.883	2.470	4.983

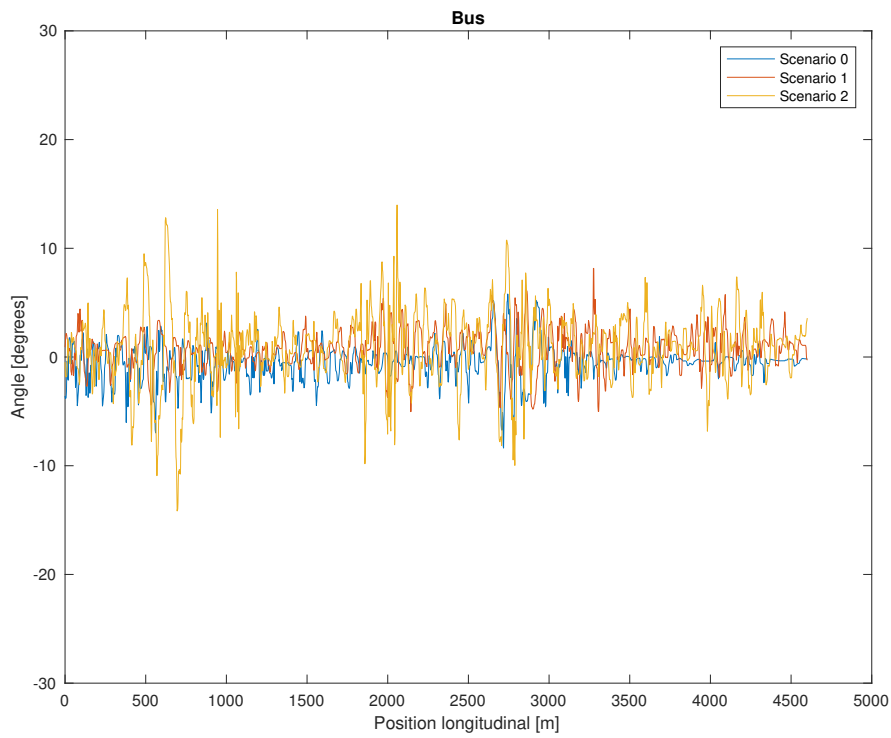

Figure 4.13: Data from test driver 3: Steering angle.

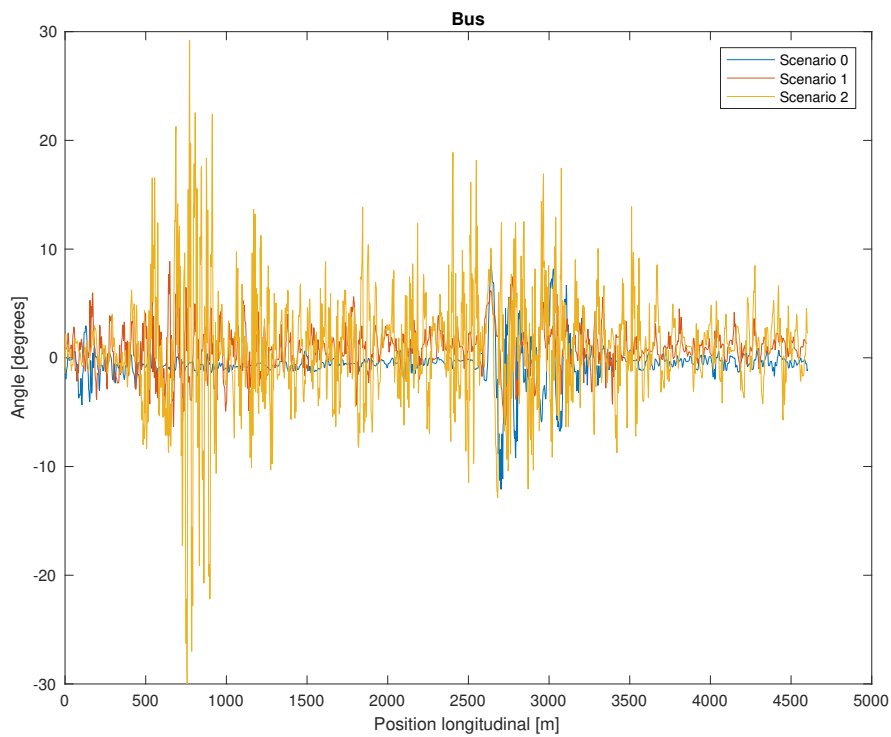

Figure 4.14: Data from test driver 7: Steering angle.

4. Results

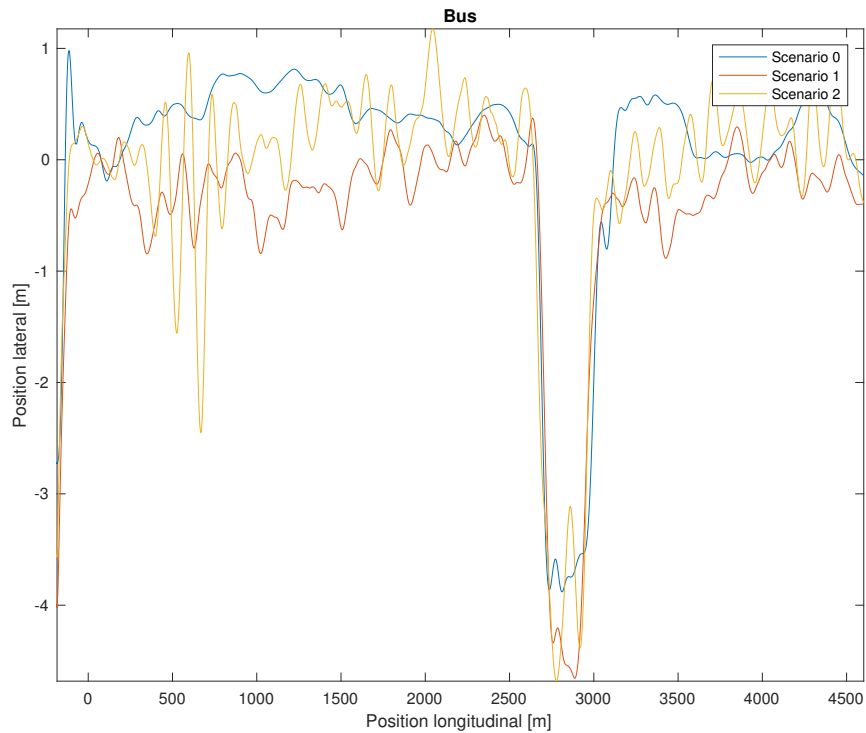

Figure 4.15: Data from test driver 7: Position of the bus.

The same FFT analysis was performed on the bus as for the car, and similar conclusions can be drawn from the bus data, see figure 4.16 and 4.17. As exemplified in figure 4.17, the frequency of steering correction increased to several times that of the bridge's frequency, figure 4.6.

Test driver 9 had to do more steering corrections than test driver 3, which implies that it was more difficult to control the vehicle for test driver 9. This could be due to the different driving styles.

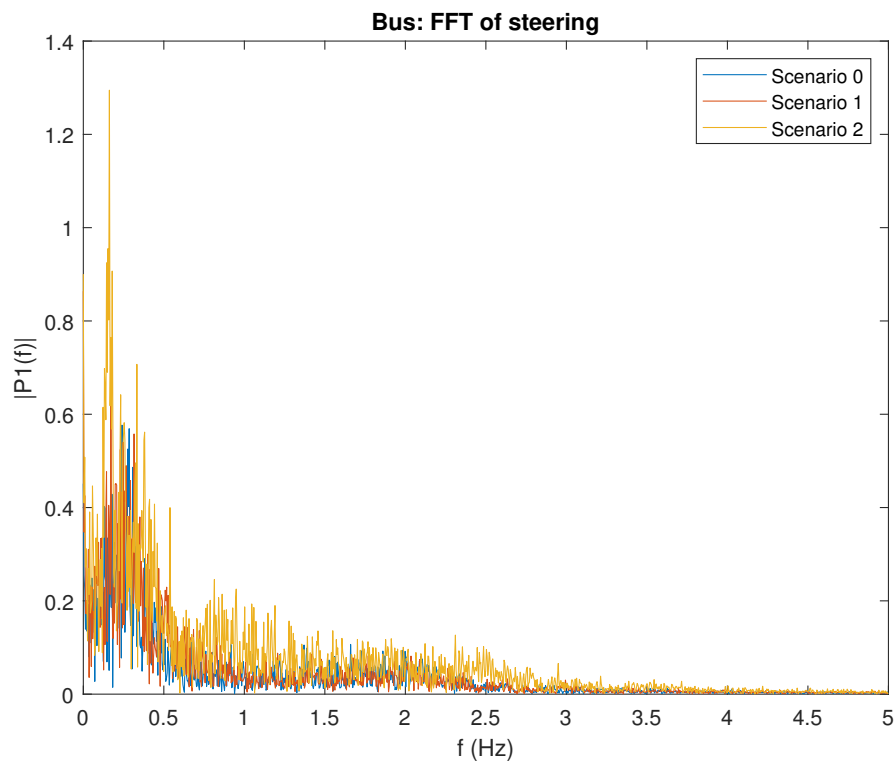

Figure 4.16: Data from test driver 3: FFT of steering angle.

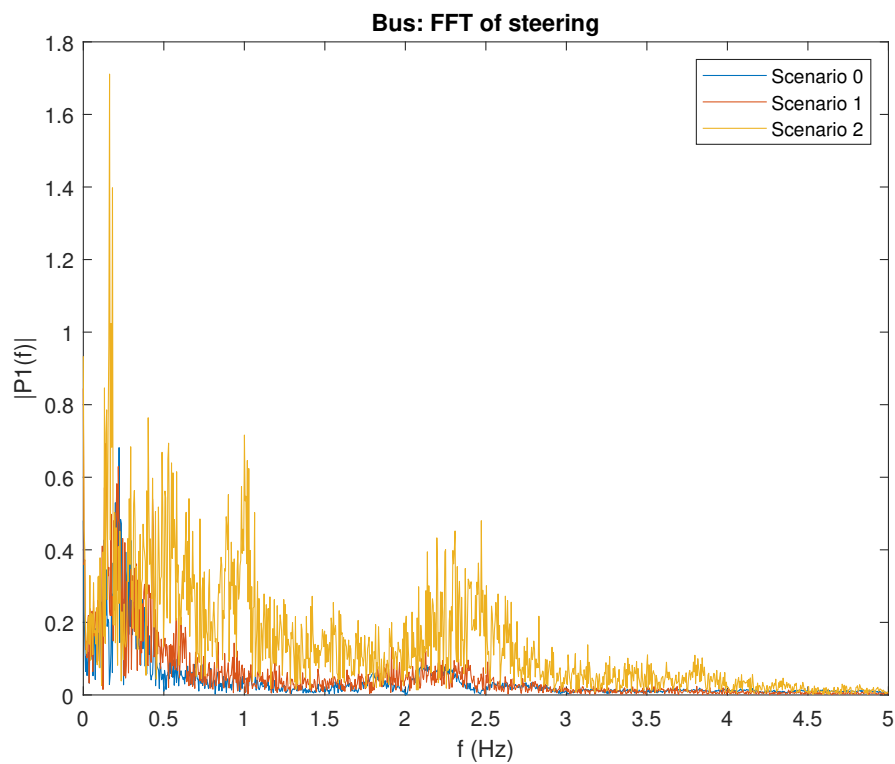
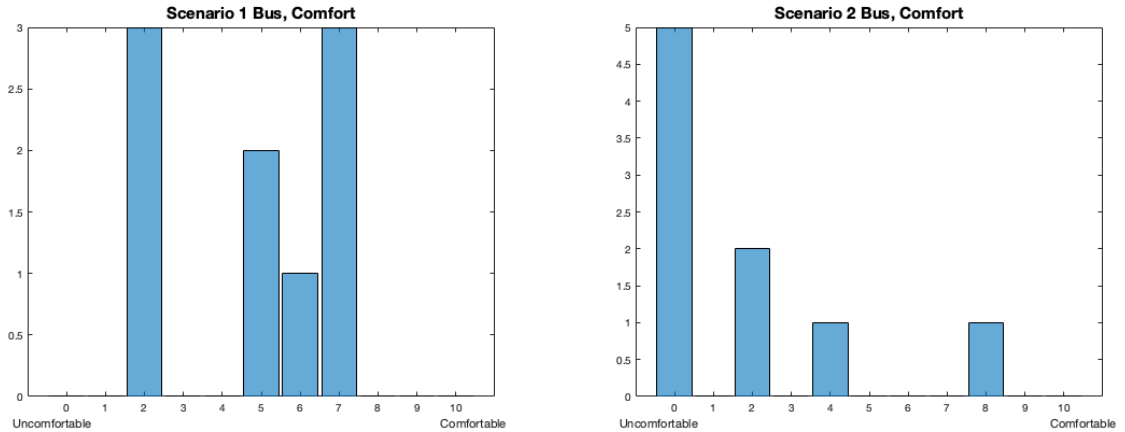

Figure 4.17: Data from test driver 9: FFT of steering angle.

4.3.2 Comfort

For the bus model, the results of the questionnaire about comfort were unanimous for most parts, see figure 4.18. There is one participant (test driver 2) that thought scenario 2 was more comfortable than scenario 0. While looking at this driver's vertical acceleration from the telemetry data, see figure 4.19, this should not be the case. Scenario 2 has higher peaks than the other two and a higher frequency overall.



(a) Scenario 1.

(b) Scenario 2.

Figure 4.18: Result from questionnaire: Comfort.

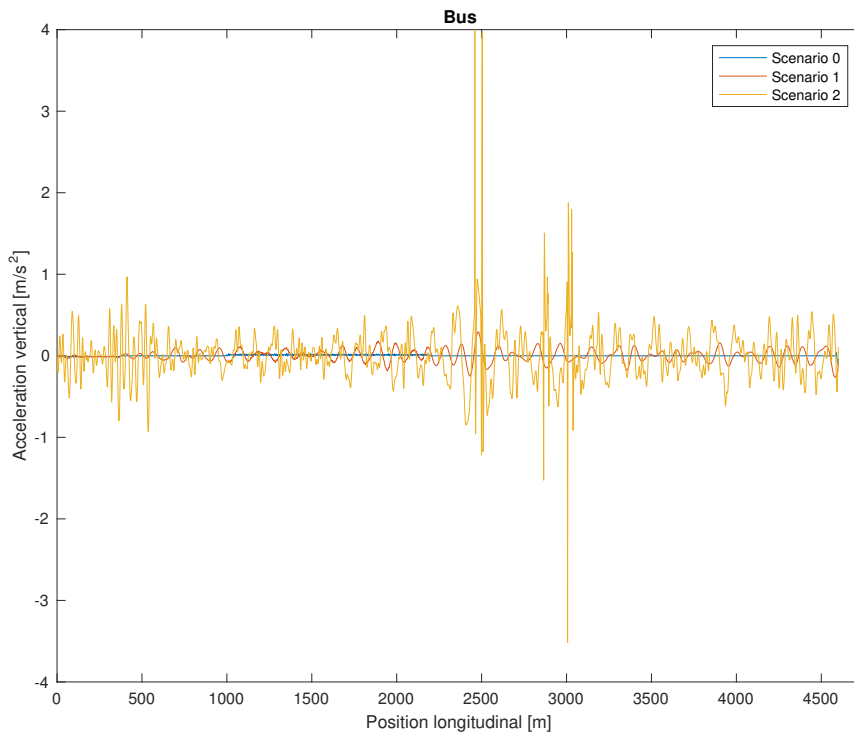

Figure 4.19: Data from test driver 2: Vertical acceleration.

4.4 Overall results from simulator

The test drivers thought that the car model and the bus model felt similar to driving the simulator with another more developed vehicle, see figure 4.20. To generate a feeling how the simulation is running can be quite difficult when driving on a straight bridge. The vehicle models felt the same as a more developed car driving in a constant speed, but testing it on a test track with turning and braking the result might not yield the same response.

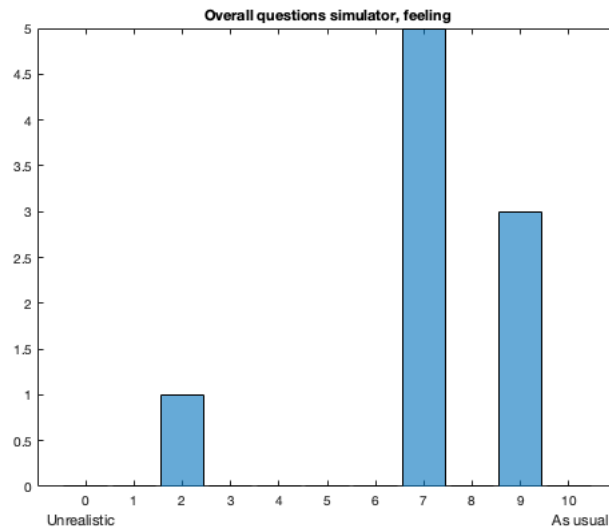

Figure 4.20: Result from questionnaire: The feeling of the simulator.

Using experienced Caster simulator drivers resulted in less test drivers being affected by motion sickness than the result presented in the theory chapter, see section 2.3.5. In theory chapter the result concluded in 62,5 % compared to the result of this study with 11,1 %.

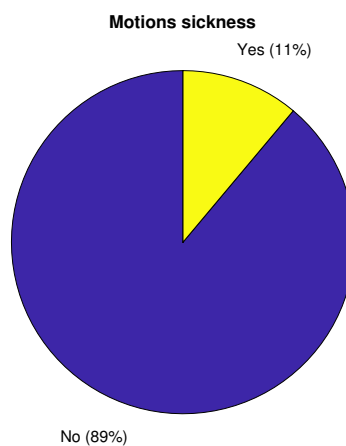

Figure 4.21: Result from questionnaire: Motion sickness.

4. Results

From the questionnaire, most of the participants thought that the bus in scenario 2 was the most difficult one, while others thought it was the car in scenario 2, see figure 4.22.

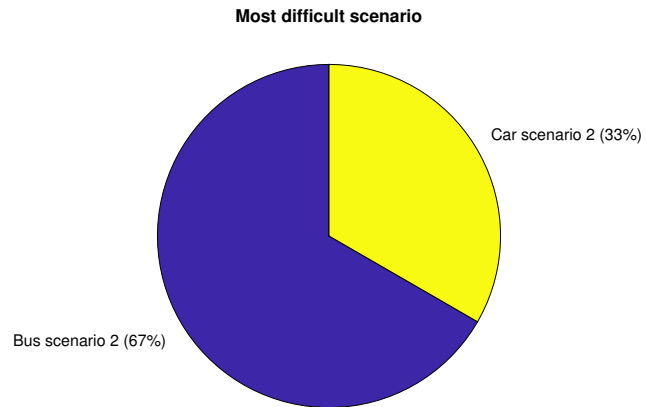

Figure 4.22: Result from questionnaire: Worst case scenario.

5

Discussion

In this chapter, the results of the project and future work recommendations will be discussed.

5.1 General

When analyzing the results from the questionnaires and telemetry data, both the car and bus vehicle models can be assessed to work satisfactory. All the figures shown in chapter 4 shows that more wind and wave motion will have an impact on the vehicle models. Therefore, it concludes that they are working properly relative to the motion data. Higher load cases will have an impact on the vehicle models dynamic response. According to the data gathered through the questionnaire, see section 4.4, figure 4.22, most test drivers found both models to be reasonable and realistic.

5.2 Vehicle model

The vehicle models developed during this project is a realistic assessment of the driving conditions if used in the intended driving scenarios. We know that the bus model has several issues in dynamic driving scenarios and requires further development, suggestions for this is discussed in section 5.3.

The question about simulator feeling reflects the models in a good way. This because we only used drivers that are experienced in driving the simulator and knows how it normally feels. This validates the feeling of the simulation and not its real-world accuracy.

A more detailed model will require more computational power to run fast enough. As discussed in the thesis *Validation of a Moving Base Driving Simulator for Subjective Assessments of Steering and Handling* [3], the model also has to be verified for every scenario it will be used for. Just because it simulates one situation well, it might not handle a different situation as good. Therefore the models ideally needs to be verified against vehicles driving on moving surfaces in real life. The more detail and less simplifications made to the model will result in a model being more accurate and representative to a real vehicle, but ends up being more computationally demanding. One such area is compliance, or how the parts of the model that are modeled as rigid actually would move. The suspension is one major area where simplifications

have been made. There are many bushings with elastokinematic properties that are simply modeled as joints that only rotates, and not displacing as well.

5.3 Future work

The project has produced a method for testing a bus and a car driving on a moving bridge in a constant speed scenario. Due to time and scope constraints there are some areas to improve the vehicle model and driving experience.

Testing different road conditions such as rain, snow and ice would be interesting due to the reduced grip these conditions lead to. In Norway the weather conditions vary a lot during a year and rain would be a frequent occurrence. It would lessen the safety margin to a loss of grip scenario and demand more from the driver.

5.3.1 Driving experience - Visual

The graphical model of Bjørnafjorden and the bridge is pretty bare bones and static. The model gives little to no reference of orientation nor speed sensation. Adding accurate lane markings, texture with noise to the asphalt and posts to the crash barrier will give the driver a better sense of speed. Adding boats or other objects in the water might help with absolute orientation in the world. Increasing the render distance of objects might also be a solution.

Because the bus model's left mirror is completely obstructed by the screen bezels its function as an aid to stay in lane is therefore nullified. Changing the parameters of the camera should solve this problem and allow the driver to see the position of the vehicle relative to the road markings.

5.3.2 Driving experience - Soundscape

Some drivers felt as if the scenarios were too similar and that nothing differentiate them. Adding audio for wind will contribute to the experience, and add impression to the seriousness of the weather conditions.

The simulator room is a noisy environment but in an entirely different way than a vehicle. The large movements of the motion platform causes a lot of noise that interferes with the drivers immersion. Using isolating headphones should reduce the amount of unwanted noise.

5.3.3 Vehicle model - Driveline

The current implementation of the driveline in the model does not include the inertia of the tire itself and therefore the tires accelerate too quickly. This generates too much longitudinal force and accelerates the vehicle too quickly. The bus model is affected the most, one solution might be to improve the model for how the tires are connected

to the driveline. Additionally, mapping the throttle to limit the torque output of the engine could help lessen the amount of wheel spin.

5.3.4 Vehicle model - Tire model

Tuning the tire model is recommended in order to improve the dynamics of the bus. As it stands, the bus tire model has issues longitudinally and is therefore not suitable for dynamic driving scenarios. Ideally one would acquire tire data files specific for this bus since that would be a drop-in replacement and require little time.

It seems as if the tires can generate too much force longitudinally, especially at high slip ratios. This can be tuned by scaling factors for grip drop-off at higher slip ratios.

5.3.5 Vehicle model - Bridge roll

Adding bridge rolling will add another level of realism and increase the difficulty of driving. Roll will add to the bridge movement vertically as well as rolling the car. Angular movement might have a greater effect on the driver than the low accelerations the bridge at this moment induces.

5.3.6 Vehicle model - Suspension

There is room for improvement in the bus suspension, as its springs are at the moment linear. Adding a non-linear component (i.e. bumpstops) might improve handling during acceleration phases since it squats and dives quite a bit in its current state.

The car suspension could use a sanity check and go through all hard-point coordinates, both in Simscape and the car configuration file.

5.3.7 General Simulink improvements

Changing the initialization script to read the starting coordinates from Panthera would make changing tracks easier and more seamless. Also adding the initial rotation the vehicle along the Y-axis.

The surface interaction blocks inside the Simulink model behave strangely every time the track changes. The coordinate system twists to the one used inside Panthera and then produces useless data. This can temporarily be fixed by changing the Simulink model to an earlier one that does not behave like this, and then change back to the correct model. The cause of this behavior is currently unknown.

5.3.8 Vehicle model - Validation

To use this simulation for setting speed limits and other restrictions for the bridge the model needs to be validated and verified. Ideally on a Kinematic & Compliance rig with the ability to displace the vehicle on the measurement rig. With loads

and movements known, one would tune parameters in the model to replicate the output from the measured data. Due to the muchness of parameters and systems to tune such an undertaking requires a deep level of knowledge of the model and the underlying systems in conjunction with time and persistence.

5.3.9 Driving trials

Different improvements could have been made to the driver trials. Some of the questions in the questionnaire could have been more clearly formulated. The test drivers did not understand what some of the questions implied and had to ask for clarification. The rating scale of the questionnaires was not consistent regarding the emotive either, which might have confused the test driver and affected the result. The test drivers should have also taken more time when answering the questions in between scenarios. Maybe a more thorough introduction to emphasize the importance of the questionnaire would have solved this.

The setup of the trials could have been different as well. A different way to implement the trials would have been to have the test driver drive each scenario multiple times. Having the test driver drive more would yield more data and progress along the learning curve of driving in such an environment. Too much driving for the test driver might compromise the result due to the drivers learning to handle the scenario. This was discussed but would have demanded more time from us and from the test drivers performing the trial.

All the results derived from the bus were from test drivers who have never driven a real bus before. For the bus model it would have been ideal to use bus drivers to perform the trials. What was discussed was the learning curve of the simulator, which might have impacted the end result. Having external drivers would ultimately have ended up taking more time preparing for, performing, and evaluating the trials.

6

Conclusion

The thesis' objective was to develop a method for investigating how a vehicle's track-ability, and consequently a driver's ability to safely travel over the bridge, is influenced by the motion of the bridge and crosswind. The method was then validated by performing a driver study. The data from the study showed that an increasing storm intensity will require the driver to perform more steering corrections to keep the vehicle's in lane, and that the lateral position deviated more. The method developed can therefore be considered to be operative. It is a valid approach to use for further investigations about vehicles on floating bridges. It can also be used as inspiration for other similar projects, where the driving scenario is unavailable for testing. The method can be improved if the recommendations from the future work section 5.3 are integrated.

Bibliography

- [1] Handout about suspension design in the course TMME11 Road Vehicle Dynamics. URL: http://www.mechanics.iei.liu.se/edu_ug/tmme11/utdelat18.pdf.
- [2] A. Albinsson. “Online and Offline Identification of Tyre Model Parameters”. 2018.
- [3] Carl Andersson Eurenium and Josu Donnay Cortiñas. “Validation of a Moving Base Driving Simulator for Subjective Assessments of Steering and Handling”. MA thesis. 2015.
- [4] Racing Aspirations. *What is Bump Steer*. 2017. URL: <https://www.racingaspirations.com/bump-steer/> (visited on 04/15/2019).
- [5] Mackinac Bridge Authority. *How much does the Mackinac Bridge “swing” or “sway” in the wind?* 2016. URL: <https://www.mackinacbridge.org/uFAQs/much-mackinac-bridge-swing-sway-wind/> (visited on 02/19/2019).
- [6] Jennifer L. et.al Campos. *Guiding Framework for Driver Assessment Using Driving Simulators*. 2017. URL: <https://www.frontiersin.org/articles/10.3389/fpsyg.2017.01428/full> (visited on 04/04/2019).
- [7] Caster. *Engineers in the front seat*. 2019. URL: <https://www.casterchalmers.se> (visited on 01/30/2019).
- [8] Suspension Designer. *KPI - Compliance Steer*. 2019. URL: <https://www.suspensiondesigner.com/kpi-compliance-steer/> (visited on 05/09/2019).
- [9] Edy. *Facts and myths on the Pacejka curves*. URL: <https://www.edy.es/dev/2011/12/facts-and-myths-on-the-pacejka-curves/> (visited on 03/05/2019).
- [10] Edy. *Pacejka Magic Formula*. URL: <http://www.racer.nl/reference/pacejka.htm> (visited on 03/05/2019).

- [11] Y. Fujino and D. Siringoringo. *Lateral Stability of Vehicles Crossing a Bridge during an Earthquake*. 2016. URL: <https://ascelibrary.org/doi/10.1061/%28ASCE%29BE.1943-5592.0001211> (visited on 02/19/2019).
- [12] T. Gillespie. *Fundamentals of Vehicle Dynamics*. 1992.
- [13] G. Gómez. *Towards efficient vehicle dynamics evaluation using correlations of objective metrics and subjective assessments*. 2015. URL: <http://kth.diva-portal.org/smash/get/diva2:819660/FULLTEXT01.pdf> (visited on 04/04/2019).
- [14] B. Jacobson. *Vehicle Dynamics*. 2016.
- [15] I. Johansson. *Suspension System*. Lecture in TME121 Engineering of Automotive Systems. Unpublished. 2018.
- [16] M. Juhlin. *Assessment of crosswind performance of buses*. 2009. URL: <https://www.diva-portal.org/smash/get/diva2:216431/FULLTEXT01.pdf> (visited on 02/21/2019).
- [17] J. Katz. *Race Car Aerodynamics*. 1995.
- [18] Multiconsult. *Bjørnafjorden, Straight Floating Bridge phase 3*. 2017.
- [19] Land Transport NZ. *Heavy combination vehicle stability and dynamics*. URL: <https://www.nzta.govt.nz/assets/resources/heavy-learner/heavy-combination-vehicles/docs/heavy-combination-vehicles.pdf> (visited on 02/14/2019).
- [20] WV Local Technical Assistance Program. *Why Bridges Sway and Bounce*. 2016. URL: <https://wvltap.wvu.edu/assets/bridgedecksandjoints.pdf> (visited on 02/19/2019).
- [21] E. Gunnarsson R. Löfwenberg K. Ivancic. “Modelling and Validation of a Dynamic Vehicle model for use in a Motion Based Simulator”. Bachelor thesis. Chalmers University of Technology, 2018. URL: <http://publications.lib.chalmers.se/records/fulltext/255440/255440.pdf>.
- [22] D. Sekulic. *Effect of floating bridge vertical motion on vehicle ride comfort and road grip*. URL: https://www.vegvesen.no/_attachment/2487039/binary/1294853?fast_title=Effect+of+floating+bridge+vertical+motion+on+vehicle+ride+comfort+and+road+grip.pdf (visited on 03/05/2019).
- [23] T. et.al Stroffregen. *Effects of decades of physical driving on body movement and motion sickness during virtual driving*. 2017. URL: <https://doi.org/10.1371/journal.pone.0187120> (visited on 02/26/2019).

- [24] WSP. *SR520 Evergreen Point Floating Bridge*. 2019. URL: <https://www.wsp.com/en-US/projects/sr520-evergreen-point-floating-bridge?fbclid=IwAR24ftWGsZv7dzJRzstoF8zvxFusE5oJo1Y9Eg17f5wq-6rgX40b4AFFnU> (visited on 02/19/2019).

A Simulink model

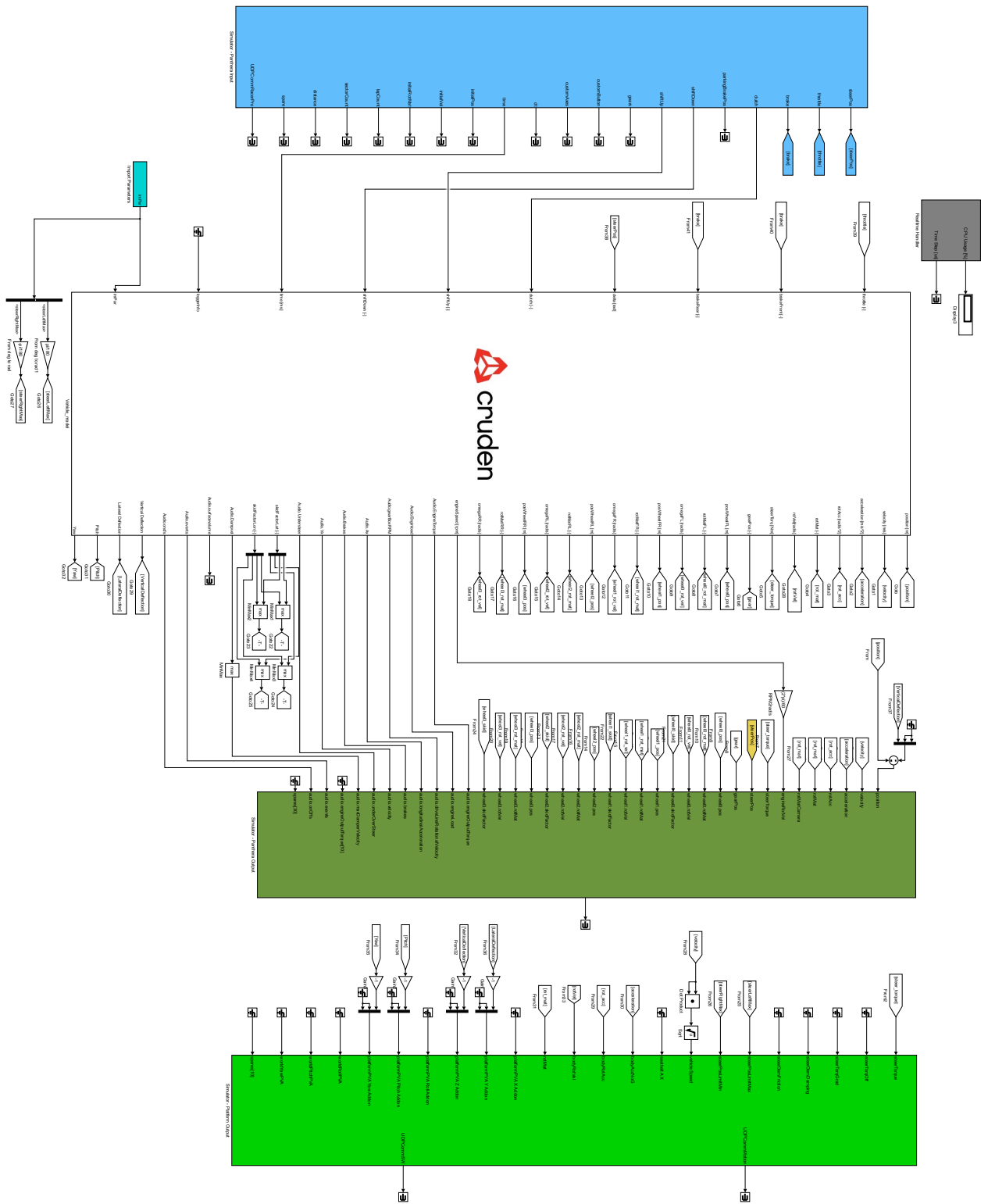

B

Bus parameters

Curb weight	18 000 [kg]
Front area	7.67 [m ²]
Side area	39.9 [m ²]
Drag coefficient	0.39
Side drag coefficient	1.1
Inertia tensor	$\begin{bmatrix} 54054 & 0 & -37011 \\ 0 & 334484 & 0 \\ -37011 & 0 & 301567 \end{bmatrix}$ [kg · m ²]
Distance between CoG and front axle	3.66 [m]
Distance between CoG and rear axle	2.29 [m]
Axle height	0.49 [m]
Track width front	2.107 [m]
Track width rear	1.885 [m]
Max brake torque	1 200 [Nm]
Engine mass	1 200 [kg]
Engine torque curve	1.750 [Nm], 1.000-1.350 [r/min]
Engine power	256 [kW] (360 hp), 1.900 [r/min]
Spring stiffness constant	250 000 [N/m]

C

Questionnaire

C.1 Car model

Moving bridge car run

How was your experience driving compared to scenario 0

0 1 2 3 4 5 6 7 8 9 10

Worse Better

How was it to stay in lane compared to scenario 0

0 1 2 3 4 5 6 7 8 9 10

Easier Harder

How much counter steering did you feel was necessary compared to scenario 0

0 1 2 3 4 5 6 7 8 9 10

Less More

How did you feel accelerating compared to scenario 0

0 1 2 3 4 5 6 7 8 9 10

Easier Harder

How did you experience lane change compared to scenario 0

0 1 2 3 4 5 6 7 8 9 10

Easier Harder

C. Questionnaire

How did you experience braking compared to scenario 0

0 1 2 3 4 5 6 7 8 9 10

Easier Harder

How did you experience the grip of the vehicle compared to scenario 0

0 1 2 3 4 5 6 7 8 9 10

Worse Better

How did you experience the simulator vibrations compared to scenario 0

0 1 2 3 4 5 6 7 8 9 10

More uncomfortable More comfortable

How comfortable did you feel driving over the bridge in this scenario

0 1 2 3 4 5 6 7 8 9 10

Uncomfortable Comfortable

C.2 Bus model

Moving bridge bus run

How was it to stay in lane compared to scenario 0

0 1 2 3 4 5 6 7 8 9 10

Easier Harder

How did you experience lane change compared to scenario 0

0 1 2 3 4 5 6 7 8 9 10

Easier Harder

How much counter steering did you feel was necessary compared to scenario 0

0 1 2 3 4 5 6 7 8 9 10

Less More

How comfortable did you feel driving over the bridge in this scenario

0 1 2 3 4 5 6 7 8 9 10

Uncomfortable Comfortable

C.3 Overall questions

Moving bridge simulator

The trial will examine how the driving conditions are affecting the driver

How did the simulator feel

0 1 2 3 4 5 6 7 8 9 10

Unrealistic As usual

How was your experience driving the car

0 1 2 3 4 5 6 7 8 9 10

Very uncomfortable Comfortable

How was your experience driving the bus

0 1 2 3 4 5 6 7 8 9 10

Very uncomfortable Comfortable

Did you experience motion sickness

- Yes
- No

Which scenario was the most difficult

- Car scenario 1
- Car scenario 2
- Bus scenario 1
- Bus scenario 2
- None of the above

D

Results of questionnaire

D.1 Scenario 1, car

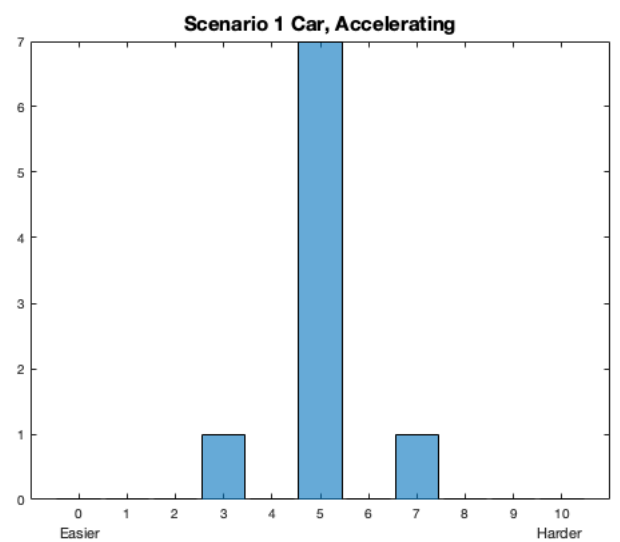
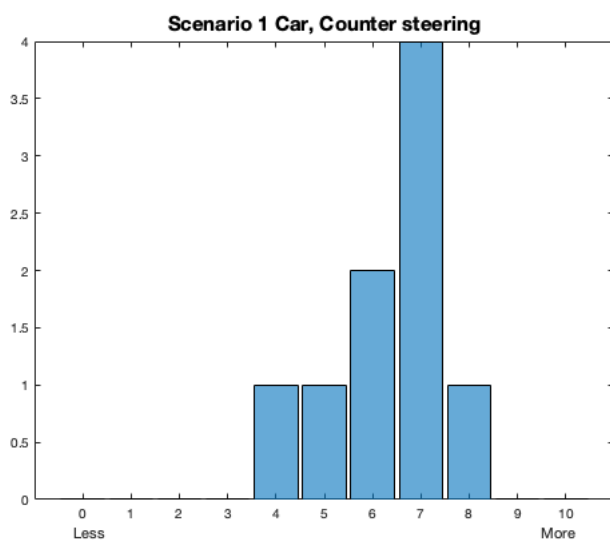
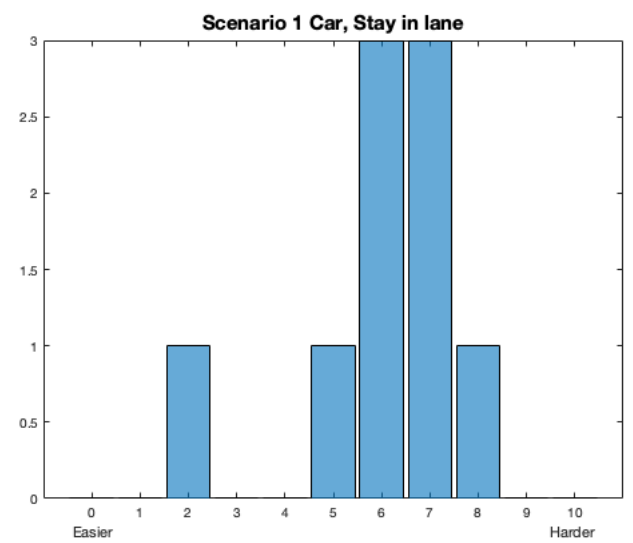
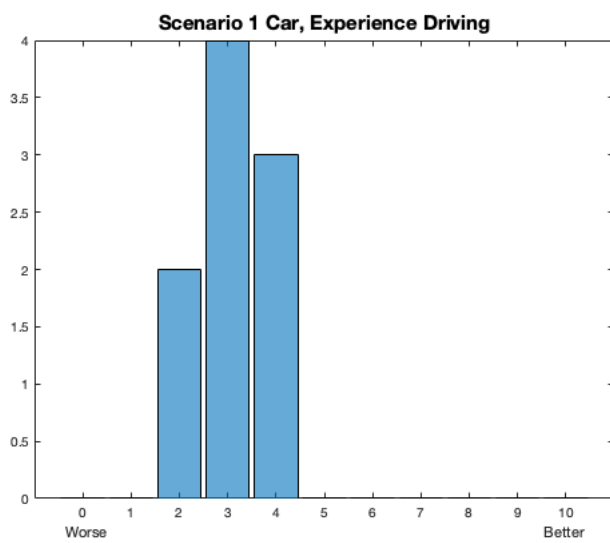

D. Results of questionnaire

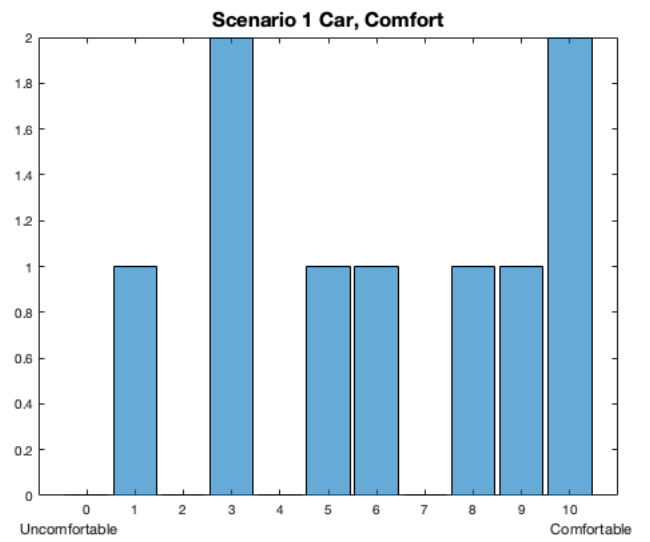
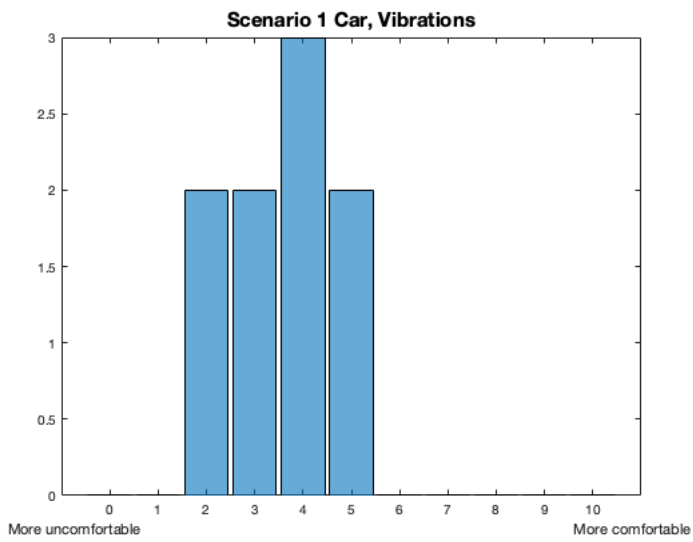
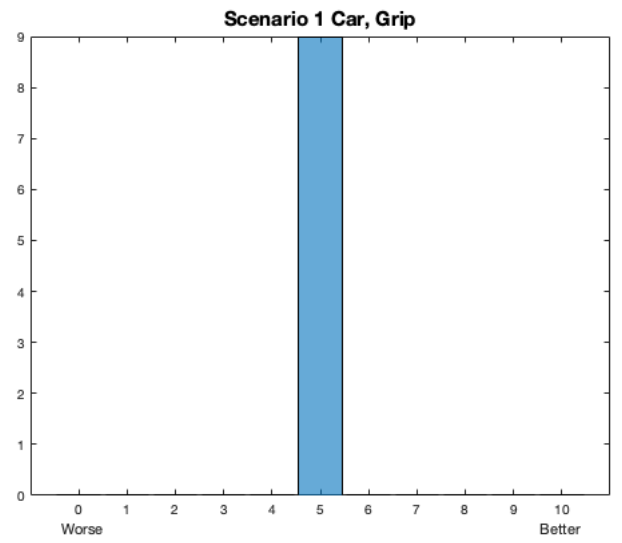
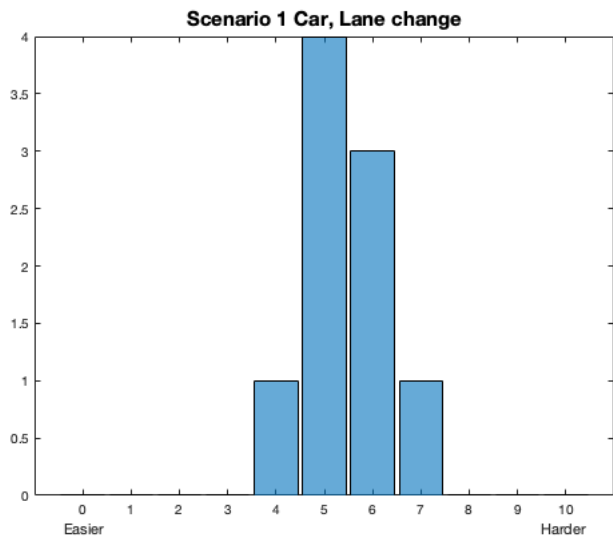

D.2 Scenario 2, car

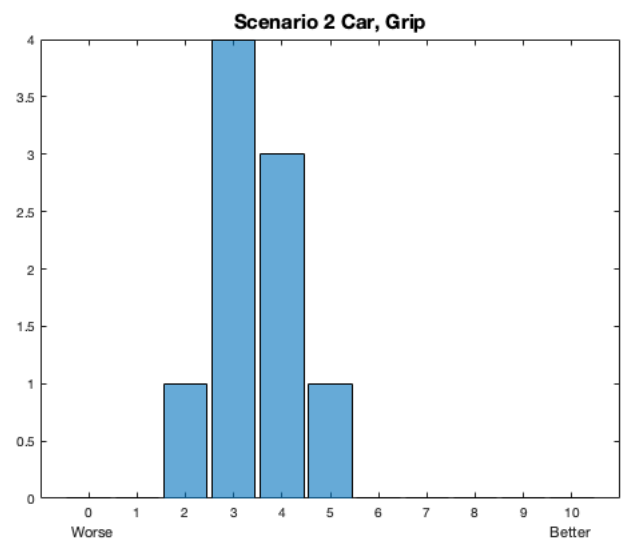
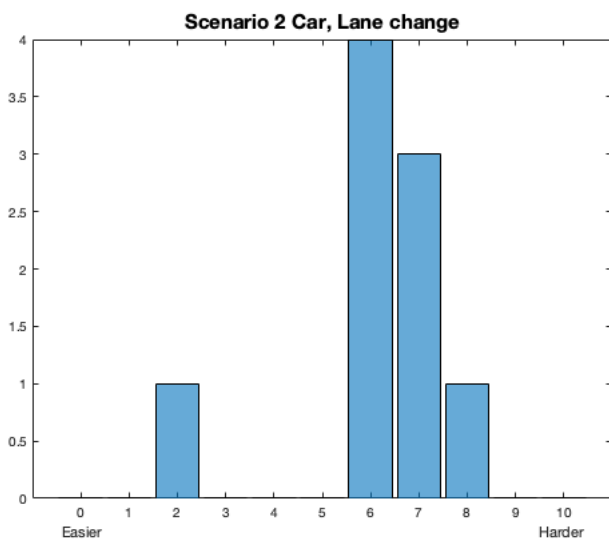
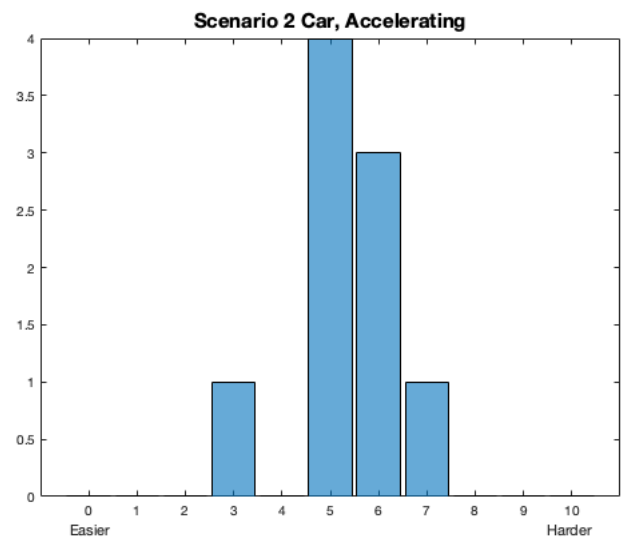
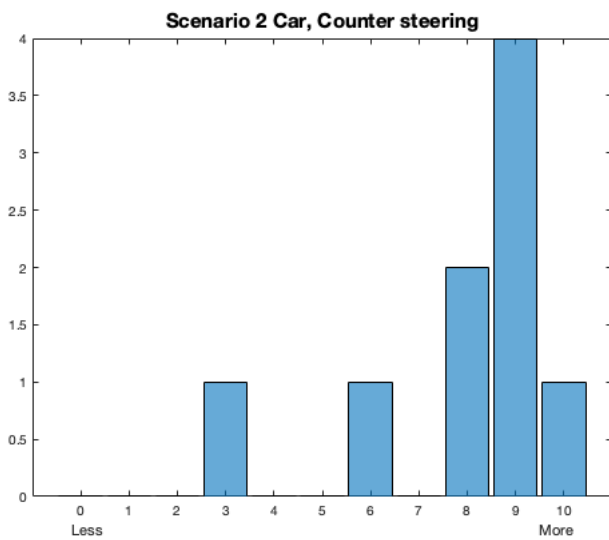
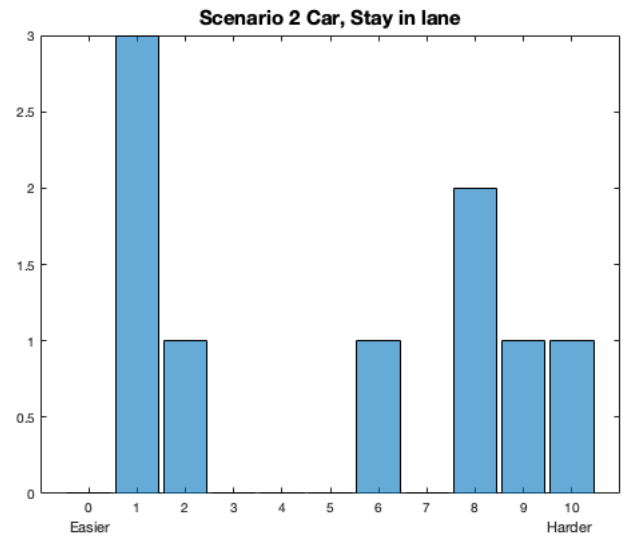
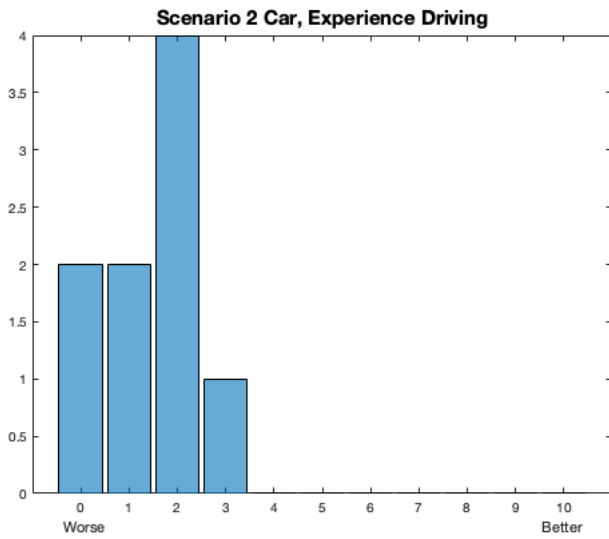

D. Results of questionnaire

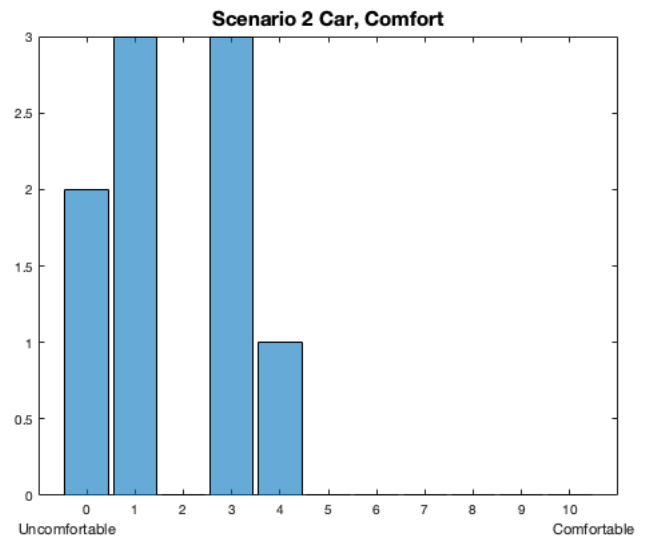
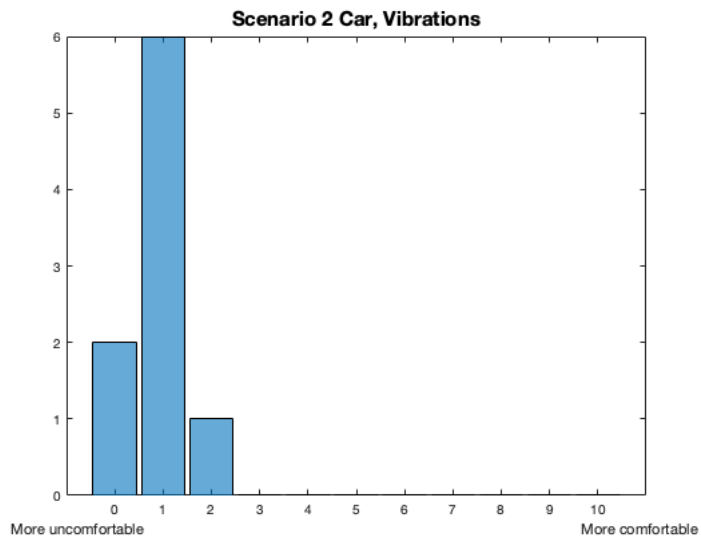

D.3 Scenario 1, bus

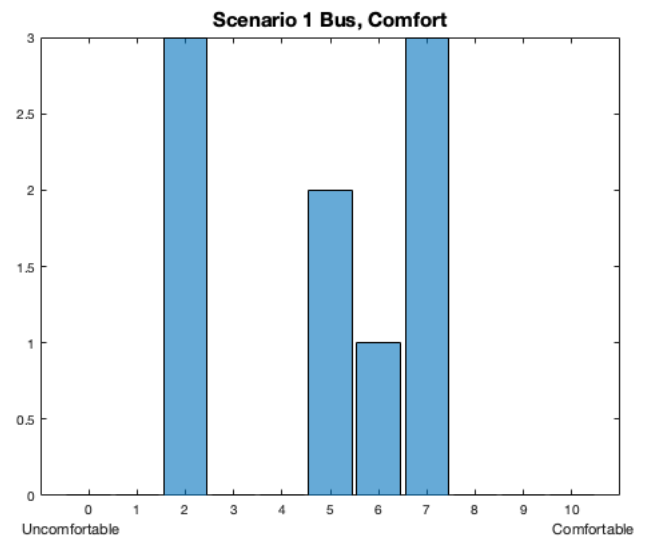
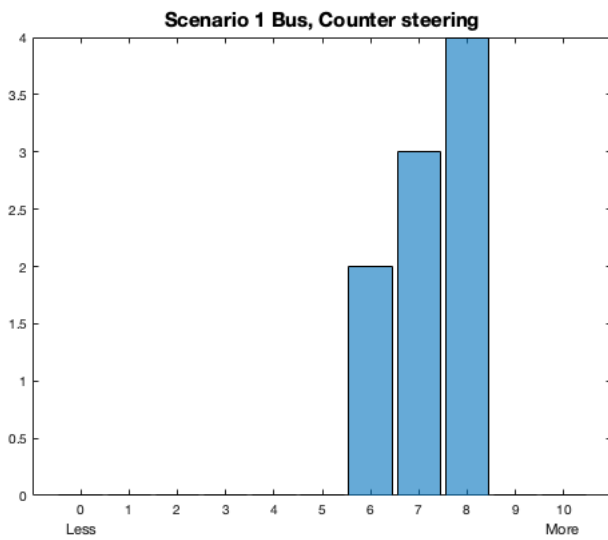
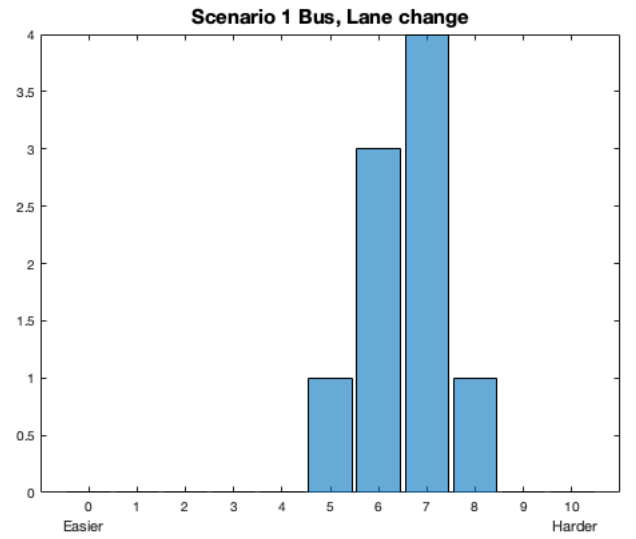
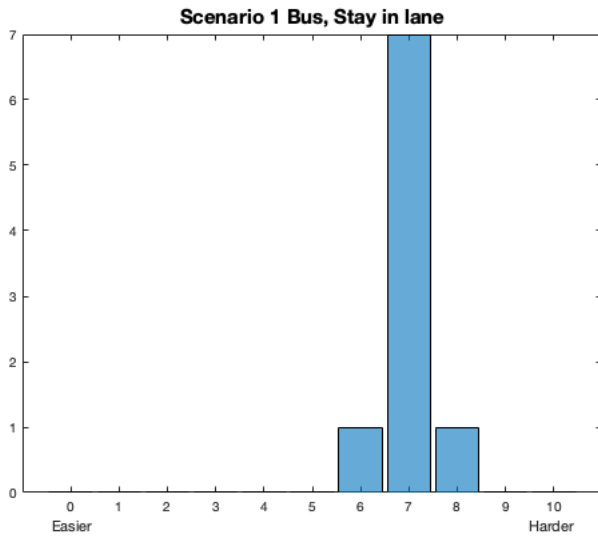

D.4 Scenario 2, bus

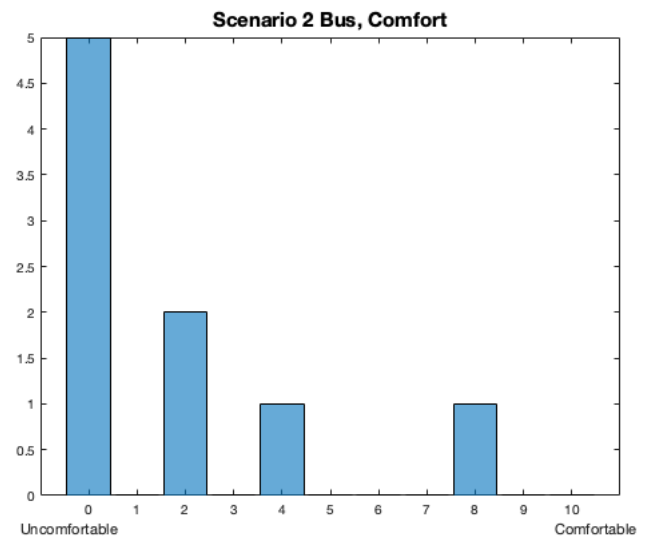
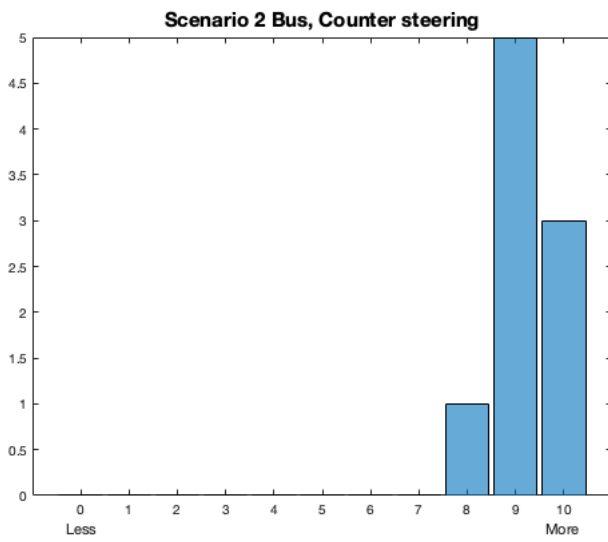
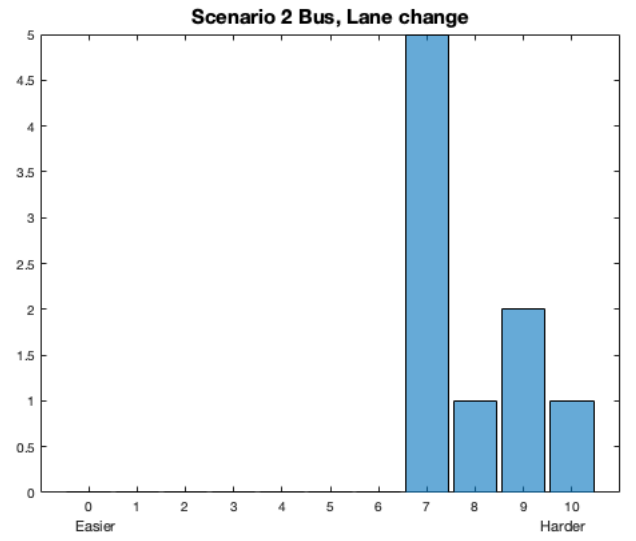
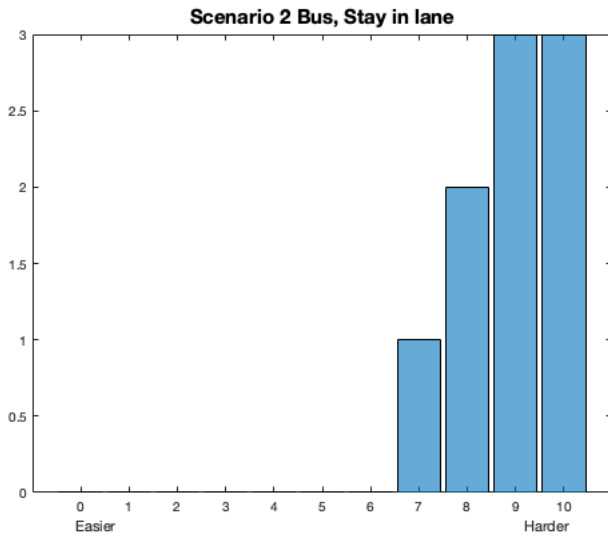

D.5 Overall questions

