

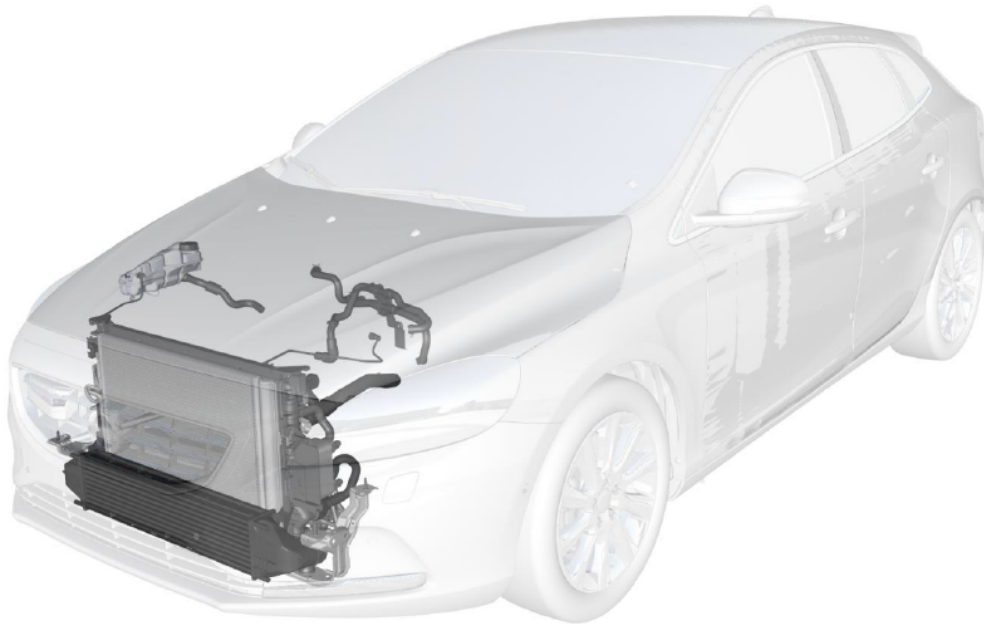

**CHALMERS**  
UNIVERSITY OF TECHNOLOGY

---



# Development of a CAD Template of the Front Cooler Pack

Improving packaging quality with a flexible and stable CAD model

Master's thesis in Product Development MSc

**MAGNUS BERTILSON**



# Development of a CAD Template of the Front Cooler Pack

Improving packaging quality with a flexible and stable CAD model

MAGNUS BERTILSON



**CHALMERS**  
UNIVERSITY OF TECHNOLOGY

Department of Product and Production Development

*Product Development*

CHALMERS UNIVERSITY OF TECHNOLOGY

Gothenburg, Sweden 2017

Development of a CAD Template of the Front Cooler Pack

MAGNUS BERTILSON

© MAGNUS BERTILSON, 2017.

Supervisors:

Kristina Wärmefjord, Chalmers University of Technology  
Friedrich Bosch, Volvo Car Corporation

Examiner:

Kristina Wärmefjord, Chalmers University of Technology

Department of Product and Production Development

Division of Product Development

Chalmers University of Technology

SE-412 96 Gothenburg

Telephone +46 31 772 1000

Cover: A visualization of the front cooler pack in a Volvo V40. Further cooling system information can be found in Chapter 2.

## **Abstract**

Volvo Cars continuously strives to improve the vehicle development process. One of the development activities during the development process is the packaging of the vehicle components. One of improving the development process is by reducing the packaging time and increasing the packaging quality. In this report, a working method for reducing the packaging time and increasing the packaging quality of some cooling components has been applied.

The master's thesis was carried out at the department Cooling System at Volvo Cars. The goal of the thesis was to create a CAD model of the cooler pack that would decrease the packaging time and increase the packaging quality. The CAD model was targeted to be applied during the early phases of the packaging of the cooler pack.

The final concept is a CAD model that has the potential of reaching the set goal.

Keywords: Cooling system, packaging quality, packaging time, CAD template, Cooler pack



## Acknowledgements

The work presented in this master's thesis was carried out at Volvo Car Corporation at the departments CAD & Mechanical Development and Cooling System Outer. I would like to thank the the people who has helped me during the master's thesis.

A special thanks to:

Stefan Molen, my manager at Cooling System Outer, for providing me with the opportunity to write this master's thesis.

Friedrich Bosch, my supervisor at CAD & Mechanical Development, for all the valuable guidance and support throughout the project.

Kristina Wärmefjord, my supervisor at Chalmers University of Technology, for the support and help during the project.

I want to say thank you to Kristofer Hansson, Bo Hansson, Helena Martini and all other colleagues at the Cooling System Outer department and at the CAD & Mechanical Development department for providing me with valuable inputs.

A handwritten signature in blue ink, consisting of stylized initials and a long horizontal stroke.

Magnus Bertilson, Gothenburg, June 2017





---

## Nomenclature

AC	Air Conditioning
BEV	Battery electric vehicle
Build to print	Manufacturing detail
CATIA V5	Currently used CAD program at Volvo Cars
Complete Cooler Pack	The heat exchangers and the fan of the cooling system
CEVT	China Euro Vehicle Technology
DoF	Degrees of Freedom
EBOM	Engineering Bill Of Material. Bill of Material is the term used to describe the "parts list" of components needed to complete a sell-able end-item
ESOW	Engineering Statement of Work
LTR	Low temperature radiator
HTR	High temperature radiator
MATLAB	Multi-paradigm numerical computing environment
NVH zones	Noise, Vibration and Harshness Zones
PS	Project start for a new vehicle program
RD Bottle	Receiver & Dryer Bottle
SCR	Selective Catalytic Reduction
Volvo Car Corporation	"Volvo Cars"



# Contents

<b>List of Figures</b>	<b>xiii</b>
<b>List of Tables</b>	<b>xv</b>
<b>1 Introduction</b>	<b>1</b>
1.1 Volvo Car Corporation . . . . .	1
1.2 Project Background . . . . .	1
1.3 Project Purpose . . . . .	2
1.4 Project Goal . . . . .	2
1.5 Project Deliveries . . . . .	2
1.6 Limitations . . . . .	2
<b>2 Theory</b>	<b>3</b>
2.1 Volvo Car Corporation’s Car Models & Platforms . . . . .	3
2.2 Cooling System . . . . .	3
2.2.1 High Temperature Radiator . . . . .	5
2.2.2 Low Temperature Radiator . . . . .	5
2.2.3 Condenser . . . . .	6
2.2.4 Fan . . . . .	6
2.3 Propulsion Systems and Cooler Packs . . . . .	7
2.3.1 Combustion Engines . . . . .	7
2.3.2 Electrical Propulsion Systems . . . . .	7
2.4 CAD Template . . . . .	8
2.4.1 The Need for CAD Templates . . . . .	8
2.4.2 CAD Template Example . . . . .	8
2.4.3 Generative Shape Design and Knowledge Advisor in CATIA V5 . . . . .	10
<b>3 Methodology</b>	<b>11</b>
3.1 Planning . . . . .	11
3.2 Concept Development . . . . .	12
3.2.1 Identifying Customer Needs . . . . .	12
3.2.2 Product Specifications . . . . .	12
3.2.3 Concept Generation . . . . .	12
3.2.4 Concept Screening and Selection . . . . .	13
3.3 System-Level Design . . . . .	13
3.4 Detail Design . . . . .	13
3.5 Testing and Refinement . . . . .	13

3.6	Company Knowledge Value Stream . . . . .	14
<b>4</b>	<b>Project Work</b>	<b>15</b>
4.1	Knowledge Acquisition . . . . .	15
4.1.1	Cooling System Study . . . . .	15
4.1.2	Current Packaging Process of the Cooler Pack . . . . .	16
4.1.3	Flexible Modelling Study . . . . .	16
4.2	Customer Needs and Target Specifications . . . . .	17
4.3	Concept Generation . . . . .	18
4.3.1	Clarify the Problem . . . . .	18
4.3.2	Search Externally . . . . .	19
4.3.3	Search Internally . . . . .	19
4.4	Concept Selection . . . . .	22
4.4.1	Concept Screening . . . . .	22
4.4.2	Refinement of the Winning Concepts . . . . .	23
4.4.3	Concept Scoring . . . . .	25
4.5	Testing and Refinement . . . . .	25
4.6	System-Level Design . . . . .	27
4.6.1	High Temperature Radiator . . . . .	27
4.6.2	Low Temperature Radiator . . . . .	31
4.6.3	The Condenser . . . . .	31
4.6.4	The Fan . . . . .	33
4.7	Design for User Experience . . . . .	33
<b>5</b>	<b>Results</b>	<b>35</b>
5.1	Final Thesis Concept . . . . .	35
5.1.1	Customer Needs Fulfillment . . . . .	36
<b>6</b>	<b>Conclusion and Recommendations for Future Work</b>	<b>39</b>
6.1	The Master's Thesis Conclusion . . . . .	39
6.2	Recommendations for Future Work . . . . .	40
<b>7</b>	<b>Discussion &amp; Lessons Learned</b>	<b>41</b>
7.1	Relevance of the Task and the Objectives . . . . .	41
7.2	Methodology . . . . .	41
7.3	Lessons Learned . . . . .	41
	<b>Bibliography</b>	<b>43</b>
<b>A</b>	<b>Mission Statement</b>	<b>I</b>
<b>B</b>	<b>Customer Needs List &amp; Target Specifications</b>	<b>III</b>
<b>C</b>	<b>Project Time Table</b>	<b>V</b>

# List of Figures

2.1	Rough schematic cooling system overview. . . . .	4
2.2	One type of a front cooler pack. 1 = The Fan. 2 = The high temperature radiator. 3 = The condenser. 4 = The low temperature radiator . . . . .	4
2.3	Illustration of HTR's main circuit: the cooling of the combustion engine. In the right hand picture horizontal designed tubes and cooling fins are highlighted. . . . .	5
2.4	The four main components of the AC circuit. . . . .	6
2.5	The four cylinder front cooler pack. Black arrow demonstrate the driving direction. . . . .	7
2.6	The BEV front cooler pack . . . . .	7
2.7	Illustrations of the CAD template of the box. . . . .	9
2.8	The steps for changing a geometrical value with the sketch-based approach. . . . .	9
3.1	Ulrich & Eppinger's product development process . . . . .	11
4.1	Comparison between a packaging model and the supplier final model of a cooler pack. . . . .	16
4.2	Main customer needs . . . . .	17
4.3	Black box of the early phase packaging and development of the cooler pack . . . . .	18
4.4	The parameter tree structure and one programming code of a CAD template . . . . .	19
4.5	The Tot Rot, 6DoFs and 3DoFs 2D concepts . . . . .	20
4.6	The Parking Sensor concept . . . . .	21
4.7	The Packaging concept . . . . .	21
4.8	The concept-screening matrix . . . . .	22
4.9	3D concept. One or two fans can quickly and easily be alternated with the roll-down parameter . . . . .	24
4.10	3D concept of 6DoFs. Parameters for translation and rotation can be seen. . . . .	25
4.11	The concept-scoring matrix. . . . .	25
4.12	New (green) and old (blue) cross section design of the HTR. . . . .	26
4.13	New HTR template design (green) and old HTR template design (blue) . . . . .	27
4.14	Parameter set of the coolant tank cross-section . . . . .	28
4.15	Restriction zone of the coolant tank . . . . .	28
4.16	Illustration of different spigot geometries with parameter input. . . . .	29
4.17	Degas spigot on the negative y-side of the radiator and on the positive y-side of the radiator. . . . .	29
4.18	Bushing seen from the left side (in the driving direction) and from a rear view. . . . .	30

## List of Figures

---

4.19	Production used holder and the template solution . . . . .	30
4.20	HTR geometries seen from the rear view in the driving direction . . . . .	31
4.21	LTR geometries seen from the rear view in the driving direction . . . . .	31
4.22	The complete condenser, the two refrigerant pipes and angle of the pressure sensor . . . . .	32
4.23	The RD bottle . . . . .	33
4.24	Different fan layouts. . . . .	33
4.25	A to-do list used during an user test . . . . .	34
4.26	Inputs on naming of parameter and parameter value . . . . .	34
5.1	The final CAD template concept . . . . .	35
5.2	BEV cooler pack . . . . .	35
5.3	Fulfillment of the initial customer needs. . . . .	36
5.4	The 'supplier a', the 'supplier b' and the 'supplier c' cross-section designs	36
B.1	List of the identified customer needs. 5 = high importance. 1= low importance . . . . .	III
B.2	Target specifications . . . . .	III
C.1	Project Time Table . . . . .	V

# List of Tables

4.1	Initial geometrical detail list . . . . .	23
4.2	HTR specification list . . . . .	28
4.3	LTR specification list . . . . .	31
4.4	Condenser specification list . . . . .	31
4.5	Fan specification list . . . . .	33





# 1

## Introduction

Volvo Cars strives to continuously improve their product development cycle. One improvement target is to reduce the product development time. Quality [12] is one of Volvo Cars' core values. A reduction of development time shall therefore be mutually achieved with increased product quality. This chapter presents detailed information regarding the background, the purpose and the goal of the project.

### 1.1 Volvo Car Corporation

The master's thesis has been conducted at Volvo Cars. Volvo Cars is one the world's best-known car brands. Volvo Cars produces premium cars including sedans, wagons, sport wagons, cross country cars, hatchbacks and SUVs. Volvo Cars visions is to be the world's most progressive and desired premium car brand. Volvo Cars mission is to make life less complicated for people, while strengthening their commitment to safety, quality and the environment [11]. The headquarter is in Gothenburg, Sweden, production takes place in Sweden, Belgium, China and Malaysia. The company is owned by Zhejiang Geely Holding of China since 2010.

### 1.2 Project Background

Cars are continuously exposed to new requirements. These can be e.g. legal requirements (e.g. emission regulations) or customer oriented requirements. As a result of the continuous drive to meet these requirements cars are built with increased system complexity and with more components. As the system complexity rises and the number of components increase, the packaging of the car components becomes more demanding. In addition to this, Volvo Car Corporation has set a goal for the year of 2020 to significantly reduce the development time. Using methods to reduce the packaging time, accompanied with increasing the packaging quality, is vital to stay competitive.

The restricted space in the car requires tests of many different geometrical shapes and positions of the components before a suitable packaging solution can be established. These tests are done in a 3D computer environment using CAD programs. The packaging tests (packaging studies) are often prolonged because the CAD methods used are not favorable for performing fast geometrical changes. One measure to decrease the packaging time is to use alternative CAD methods. A CAD template is such an alternative CAD method. CAD templates are used to speed up the development cycle and increase the packaging

quality, hence shortening time and reducing cost. CAD templates facilitate fast geometrical changes and applies system and component know-how and are therefore suitable to use during packaging studies.

### 1.3 Project Purpose

The project outcome shall increase the packaging speed and the packaging quality of the front cooler pack.

The thesis shall answer the following questions:

1. How can a CAD template be created of the front cooler pack that decreases the packaging time?
2. How can a CAD template be created that increases the packaging quality of the front cooler pack?

### 1.4 Project Goal

Deliver a CAD template model that improves the packaging quality of the front cooler pack and decreases the packaging time.

### 1.5 Project Deliveries

- CAD template of the front cooler pack
- User Guide of the CAD template
- Chalmers report on project work
- Presentation at Chalmers University of Technology
- Presentation at the Cooling System department

### 1.6 Limitations

Listed are the project limitations. The limitations with an accompanied star have been added to the list during the project.

- \*CAD template shall only include the following components:
  - the high temperature radiator
  - the low temperature radiator
  - the condenser
  - the fan
- Template is not purposed for build to print
- No finite element calculations will be performed.
- No flow or thermal calculations will be performed.
- Template developed only for the CMA and the SPA platform

# 2

## Theory

This chapter presents theoretical knowledge about the topic that is necessary for the understanding of the report's content. First of all an introduction to Volvo Car Corporation's different car models is presented. Subsequently the purpose, working principle and components of the cooling system are presented. After the introduction to the cooling system, the different propulsion systems of Volvo Car Corporation's cars are presented. At the end of the chapter CAD templates are explained.

### 2.1 Volvo Car Corporation's Car Models & Platforms

Volvo Car Corporation offer three car series; the 40 series, the 60 series and the 90 series. The 90 series and 60 series share the same platform, the *Scalable Product Architecture (SPA)* platform. The upcoming 40 series is to be built on the *Compact Modular Architecture (CMA)* platform. The CMA platform is shared between Volvo Car Corporation and CEVT. Both platforms are designed for combustion engines and hybrid propulsion systems.

### 2.2 Cooling System

The purpose of the cooling system is to keep components in need of cooling at desired operating temperatures and provide cooled fluid to the AC system. The components radiating heat from the coolants and the refrigerant are assembled together in the front of the engine compartment. In this report these components are called *the front cooler pack*. Figure 2.1 illustrates two of the cooling circuits of the cooling system. The thicker arrows shows the cooling circuit between the high temperature radiator and the engine. The thinner arrows illustrate the cooling circuit in the AC system (condenser to evaporator).

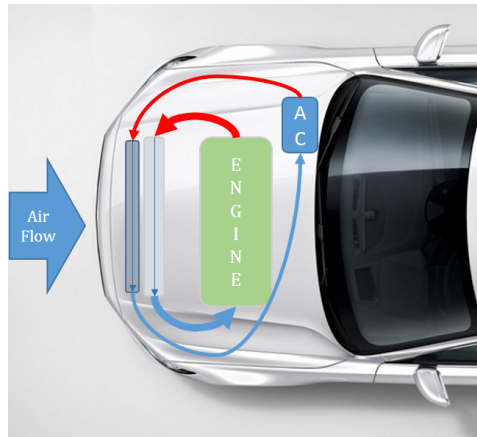

**Figure 2.1:** Rough schematic cooling system overview.

The components of the front cooler pack are heat exchangers (excluding the fan). Heat exchangers are devices that facilitate the exchange of heat between two fluids that are at different temperatures while keeping them from mixing with each other [4]. Heat transfer in a heat exchanger usually involves convection in each fluid and conduction through the wall separating the two fluids. The heat exchangers in this report are liquid-to-air heat exchangers, which in practise means that the cooling fluids radiate their heat to the surrounding air. One type of front cooler pack can be seen in Figure 2.2.

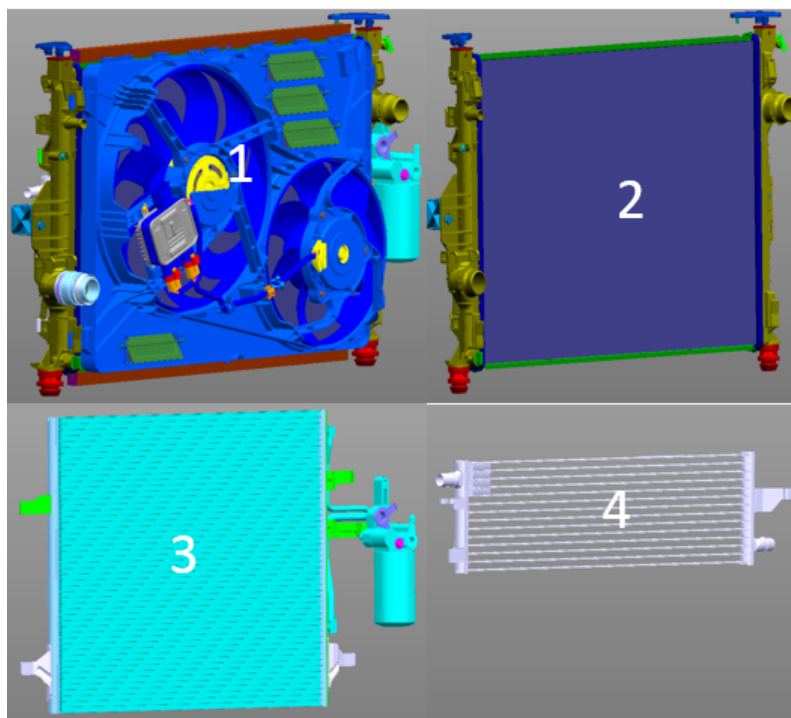

**Figure 2.2:** One type of a front cooler pack. 1 = The Fan. 2 = The high temperature radiator. 3 = The condenser. 4 = The low temperature radiator

In the top left picture the fan and its shroud (see chapter 2.2.4) can be seen from a rear oblique view. The fan is mounted in the rear of the cooler pack. In the right hand picture

the high temperature radiator (yellow colored manifolds) and the condenser (silver colored manifolds) can be seen (see chapters 2.2.1 and 2.2.3).

Performance-wise, there are two main requirements on the cooling system; to cool the engine during trail tow or hill climbing and to cool the AC system during city driving or idling. The cooling performance of the heat exchangers are highly dependent on the ambient *air temperature* and the *air flow*. Low ambient air temperature and a big air flow are beneficial for the heat exchange. The ambient air temperature can not be changed, but the air flow can be increased with a bigger heat exchanger area. Hence, the main design target of heat exchangers is to design the cooling core as big as possible. The following sub-chapters describes the purpose and working method of the cooling components of the front cooler pack for four cylinder engines and BEV vehicles (see 2.3.1 and 2.3.2).

### 2.2.1 High Temperature Radiator

The high temperature radiator (HTR) is the main heat exchanger in the cooling system. The HTR radiates heat from the combustion engine with a coolant flowing through the HTR and the engine. For automatic shifted cars a part of the radiator core is devoted to cool the coolant for use in transmission cooling. In Figure 2.3 the cooling circuit of the combustion engine is displayed.

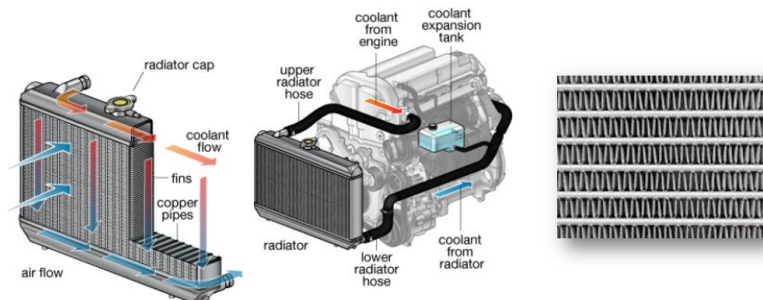

**Figure 2.3:** Illustration of HTR's main circuit: the cooling of the combustion engine. In the right hand picture horizontal designed tubes and cooling fins are highlighted.

Coolant from the HTR flows to the engine where it absorbs heat from the engine. After cooling the engine the coolant flows back to the HTR where the heat from the engine is radiated to the air flowing through the HTR. The HTR consist of a rectangular core with tubes and fins, inlet and outlet tanks with accompanying inlet and outlet spigots, one air release spigot, one drainage tap, and holders for mounting to the vehicle structure.

### 2.2.2 Low Temperature Radiator

The low temperature radiator (LTR) uses the same working principle as the high temperature radiator, but it radiates heat from other cooling circuits. The low temperature radiator is used to cool circuits of the propulsion system that demands a lower operating temperature. The low temperature radiator consists of a core with tubes and fins,

and inlet and outlet tanks with accompanying inlet and outlet spigots. Depending on the given propulsion system the low temperature radiator can be designed with an additional cooling circuit running through it.

### 2.2.3 Condenser

The condenser is one of the heat exchangers in the AC system. The AC system uses a refrigerant to adjust the air temperature of the AC air in the passenger compartment. The condenser is the part in which the refrigerant undergoes a change from gaseous stage to liquid stage. The condenser is an aluminum part that consists of a core, inlet and outlet pipes, one pressure sensor and a dryer bottle. Inside the dryer bottle there is a desiccant bag that will absorb the water in the refrigerant. The bottle is also a buffer of refrigerant. A car condenser uses the same working principle as a refrigerator, see Figure 2.4.[7]

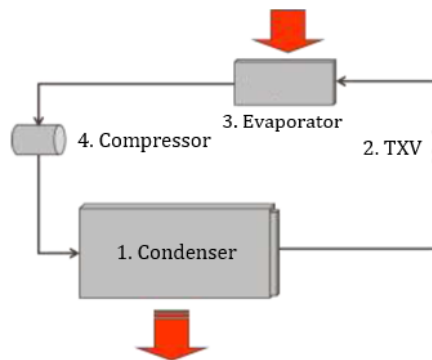

**Figure 2.4:** The four main components of the AC circuit.

The first step of the process is the delivery of cooled high-pressure liquid from the condenser. The refrigerant flows through a thermostatic expansion valve (TXV). The TXV controls the rate of flow of liquid refrigerant into the evaporator. As the flow is restricted, the pressure on the liquid drops [1]. In the evaporator the low pressure liquid absorbs heat from the air flow to the passenger compartment and by doing so evaporates. This enables the temperature of the AC air to be adjusted. The evaporator delivers low-pressure heated gas to the compressor which compresses the gas to a high-pressure state. The high-pressure gas subsequently condensates in the condenser.

### 2.2.4 Fan

The cooling performance is dependent on mainly two parameters; the ambient air temperature and the amount of air flow running through the cooler pack. The purpose of the fan is to generate additional air flow through the cooler pack, e.g. during standstill. The diameter of the fan shall be as big as possible to increase the air flow through the heat exchangers. Depending on the shape of the complete cooling kit, an additional fan can be added.

## 2.3 Propulsion Systems and Cooler Packs

This sub-chapter serves to provide a short explanation of the relation between the different propulsion systems and the cooler packs.

### 2.3.1 Combustion Engines

The engines used in Volvo Car Corporation's cars are four cylinder petrol or diesel engines. The cooler pack for the four cylinder engine consist of one fan (1), one high temperature radiator (2), one low temperature radiator (3) and one condenser (4) (see figure 2.5).

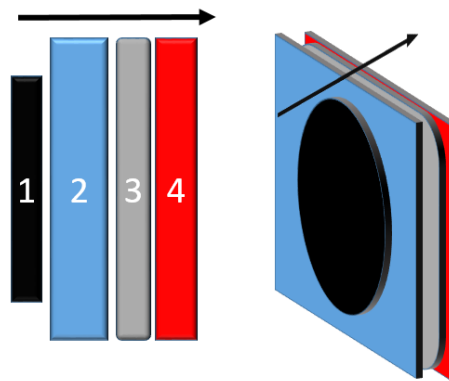

**Figure 2.5:** The four cylinder front cooler pack. Black arrow demonstrate the driving direction.

### 2.3.2 Electrical Propulsion Systems

BEV is an abbreviation that stands for battery electric vehicle. The BEV is driven by an electric engine. An electrical propulsion system does not contain a high temperature circuit (due to the absence of the combustion engine). Hence, the HTR is excluded in the complete cooling kit. The complete cooling kit consists of the fan (1), the LTR (2) and the condenser (3), see figure 2.6.

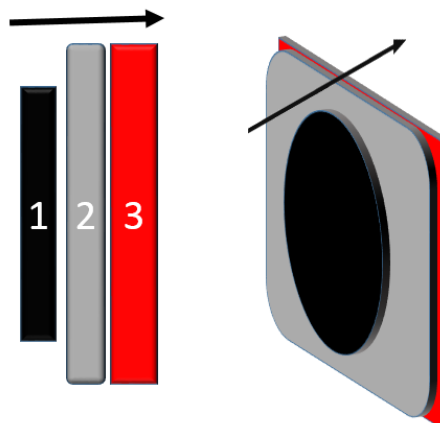

**Figure 2.6:** The BEV front cooler pack

## 2.4 CAD Template

The abbreviation CAD stands for Computer Aided Design. CAD programs are widely used within the car industry. With the tools of a CAD program, 3D models can be created. CAD has become a substitute for manual drafting of cars and car parts. Additionally in CAD e.g. finite element calculations can be carried out, 2D sketches can be created and animations can be developed. The CAD program used in this report is CATIA V5. In the following subsections the need for CAD templates and what a CAD template is are presented.

### 2.4.1 The Need for CAD Templates

A conventional approach for creating parts in CATIA V5 is *sketch-based design*. Sketch-based means that a part is created from a 2D sketch. In the sketch the dimensions and measurements of a cross-section of the part are specified. Following the completion of the sketch, a 3D geometrical shape is created. Step-by-step a complete part is created. The main benefit of the sketch-based approach is the possibility of creating a precise geometry of the part. The drawback of the sketch-based approach is the ability to carry out redesign changes. The redesign of a sketch-based part might be troublesome and very time consuming. These long lead times are very disadvantageous, because the product development cycle of a car part requires numerous redesign before a suitable design is created. To reduce the redesign lead times, CAD templates are used. CAD template models are structured in order to facilitate redesign changes, hence they are suited for development of car parts and systems. An example of a CAD template is presented in chapter 2.4.2.

The CAD templates main objective is to generate greater design maturity in early phases in order to reduce firefighting in later phases (C.Hansson, personal communication, 5th of May 2017). To reach this objective CAD templates needs to be flexible and stable, in other words: not sensitive to geometrical changes. By using CAD templates *quality, efficiency and lead time* can be improved. In the next sub-chapter an example of a CAD template is presented.

### 2.4.2 CAD Template Example

A hypothetical case will be used to present what a CAD template is. In this hypothetical case a box shall be developed with *parametrization*. This box shall be designed with a square shaped cross-section. The sides and the length of the box shall be flexible. There shall be a hole through the box. This hole's radius and position in the z direction shall be flexible. An additional requirement is that the model shall be able to change geometrical shapes quickly and easily.

The first step in creating this kind of model is to design the geometry. The second step is



to connect the measurements of the model to different parameter sets. This is done with the implemented programming tools in CATIA V5. In Figure 2.7 the parameter sets *Box* and *Hole* and their respective parameters can be seen.

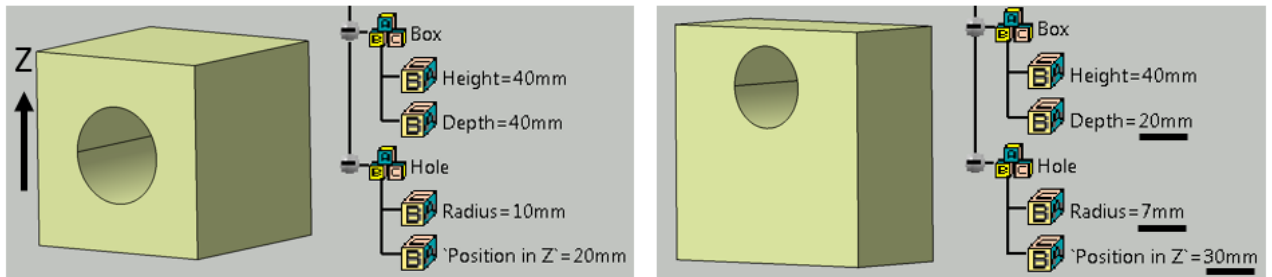

**Figure 2.7:** Illustrations of the CAD template of the box.

When these parameters are connected to the measurements of the model, changes can be done by double-clicking the parameters and setting a new value. This approach is called *parametrization*. The CAD template model requires only two steps for changing a geometrical value. This can be compared to the sketch-based approach which for this specific example would require four steps. The steps are demonstrated in Figure 2.8.

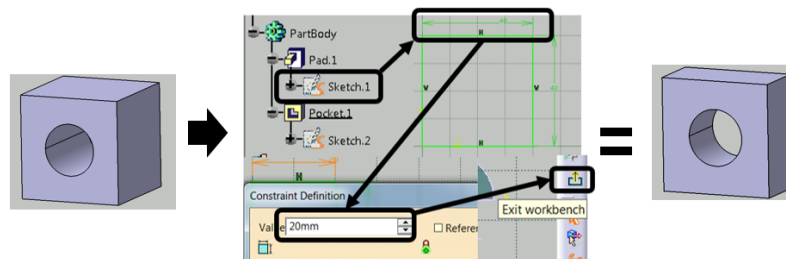

**Figure 2.8:** The steps for changing a geometrical value with the sketch-based approach.

It shall be taken into account that in this example the model is very simple. In the car industry, much more complex geometries are created. To change one single geometrical value in sketch-based model demands a lot of searching in the model tree or even re-structuring of the model. With a parameter build model, only two steps are needed. Therefore, the parametrization creates a very user-friendly model for these kinds of operations. This CAD approach demands more work when creating the model compared to the sketch-based approach, but is advantageous to use when in need of changing the shape of a part or distance to an object. Since much time is spent adjusting the position of a car part or redesigning it, a lot of time can be saved by using CAD templates.

CAD templates are further used to build in know-how into the CAD models. In the box example know-how could be implemented by informing the designer that a minimum thickness of  $x$  mm has to be kept between the edge of the circle and the edges of the box.

The main challenge when creating CAD templates is to adequately assume what needs to be flexible of the model. In the hypothetical box example the requirements (e.g. square cross-section, changeable radius and position of the hole) are stated. But if the design

engineer wants to try to design the box with two smaller holes instead of one big, the model has to be redone. If such a scenario is probable, this flexibility must be built into the CAD template.

The combination of successful parametrization and build in know-how creates CAD models that are fast and can increase the quality of the packaging and development of the car parts. In the next sub-chapter the two main workbenches in CATIA V5 for creating CAD templates are briefly explained.

### **2.4.3 Generative Shape Design and Knowledge Advisor in CATIA V5**

Generative Shape Design (GSD) is the workbench in CATIA V5 in which surface models can be created. Stable CAD models can be developed by using planes, axes and points as driving geometries of the CAD model. The Knowledge Advisor (KA) workbench provides the user with tools for programming of the CAD model. Parameter-driven CAD models can be created by using the programming tools of the Knowledge Advisor workbench. Parameter driven CAD models can, as described in 2.4.2 change e.g. geometrical shapes and positions or add or remove different features quickly compared to CAD models exclusively modelled in the *Part* or GSD workbench. Building CAD models that are stable is called flexible modelling.

# 3

## Methodology

The structure of this thesis work has been based on the methods presented by Ulrich & Eppinger [10]. The process is a well-known and acknowledged product development methodology. The methodology includes methods and tools for development of products with the main goal of creating value for the customer.

This master thesis extends from the planning phase to the testing phase, see Figure 3.1. Applicable methods with the potential of increasing the success of the project's outcome has been used. CATIA V5 has been used for the development of the Template model.

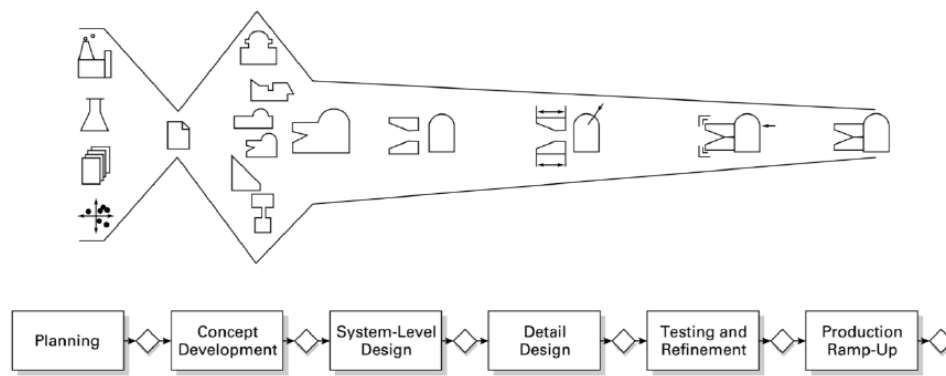

**Figure 3.1:** Ulrich & Eppinger's product development process

### 3.1 Planning

Planning is the first phase of the six development phases presented by Ulrich & Eppinger. The planning phase is also referred to as *phase zero* being the preceding phase to the actual project launch. One output of the planning phase is the mission statement which is a document providing information concerning the product (e.g. benefits proposition, key business goals and primary market). The mission statement shall during the development process guide the development team in the wanted direction.

A second output of the planning phase is the time table. The time table shall be created by identifying the project goal, followed by identifying necessary development activities

and finally organize the development activities timewise in order to reach the project goal in time.

## 3.2 Concept Development

Ulrich & Eppinger's key message for successful product development is to identify the market's needs and create a product that fulfills these needs. Therefore, the concept development starts with identification of the customer needs. The next step is to create a product specification list. This list addresses the customer needs in product related terms. Based on the product specification list concepts are generated and selected. The following subsections describes these steps.

### 3.2.1 Identifying Customer Needs

A customer's needs list is also called *the language of the customer*. The list's key benefits are: it enables a customer oriented concept development and that no critical customer need is left out or suppressed. The goal is to gather the explicit and implicit needs from the customers of the target market. Especially lead users are beneficial to gather data from because they experience needs before regular users. In the context of this project, the lead users are the engineers developing the cooler kit at Volvo Car Corporation. The identified customer needs are used as input for the creation of the product specifications.

### 3.2.2 Product Specifications

The product specifications shall give guidance during the concept development to create a successful product. The product specifications shall translate the customer needs into product specified features and functions, make the future product to stand out from the competitors and be technically and economically feasible. The product specifications list is at least established twice. The first list is called *target specifications*. According to Ulrich & Eppinger the target specifications symbolizes the high hopes and initial goals of the development team before sufficient knowledge is gathered. Therefore, these target specifications are reviewed and updated during the concept development as new relevant knowledge is acquired.

### 3.2.3 Concept Generation

During this phase multiple product concepts are generated to address the identified needs and the product specifications. It is a highly creative phase during which the development team might generate hundreds of concepts. During the phase iteration is very probable, especially when developing new kind of products. The output of the phase is a couple of concepts. These concepts shall be evaluated against each other during the screening and selection phase. In this project the concept generation shall starts with 2D sketches of the concepts and evolve into 3D model of some concepts before the concept screening.

### 3.2.4 Concept Screening and Selection

The concept screening and selection are done to identify the most promising generated concept or concepts based on the customer needs and other relevant criteria. The *Pugh Matrix* and the *Kesselring Matrix* are matrices for concept evaluation. These matrices can be seen as filters that let through concepts based on their strengths and weaknesses with regard to the list of criteria. Another benefit of the matrices is that visual documentation of the decision-making process is established. During this project the criteria for choice of concepts shall be derived from the product specification list and customer needs list. Additionally alpha prototype tests shall be carried out during the selection of concepts. Read more detailed description about alpha prototyping in the chapter 3.5.

## 3.3 System-Level Design

The purpose of the system-level design phase is to develop a more structured and detailed design of the chosen concept. The phase includes the definition of the product architecture, decomposition of the product into subsystems and components, and preliminary design of key components. The system-level design phase shall additionally facilitate the physical assembly process of the product. Since the final product of this project shall be a CAD model, no preparation activities for physical manufacturing shall be performed.

## 3.4 Detail Design

This phase includes the final specification of the product; e.g. drawings and computer models of the product, material selection, tolerances for production, production cost et cetera. For a physical product the phases involves the methods *Design for Environment*, *Design for Manufacturing* and *Robust Design*, but for this project foremost *Design for Use* shall be the focus (since no physical product is to be produced). Design for use is important because a template model needs an user interface that is easy to understand. Therefore, knowledge and methods from the area of design for use and *User experience* shall be implemented [8].

## 3.5 Testing and Refinement

The testing and refinement phase is for testing alpha and beta prototypes. Alpha prototypes possess production-intent parts, i.e. parts with same geometry and material properties as the intended final production version of the product. Alpha prototypes are used to evaluate if the product fulfills the customer's needs. The beta prototype evaluates the performance and reliability of the product to create input for necessary engineering changes before the final product is defined. Since the final product of this project is a CAD model, the lead times for creating prototypes are very short. Getting inputs from the customer continuously during the product development phases is beneficial for assuring that customer needs are met and for gathering of new needs. Therefore, testing of prototypes was decided to be run continuously during the development of the concepts.

## **3.6 Company Knowledge Value Stream**

This subsection is not a part of the Ulrich & Eppinger methodology. Its included because documentation of work is a critical activity for sharing and maintaining knowledge within a company. It is important for a company that tacit knowledge is made explicit and spread [6]. To ensure that the findings of this project are spread accordingly within the company, both a user guide and a report were decided to be project deliveries (see chapter 1.5). The user guide includes a description of the template model structure and the parameter structure of the template model. The documentation is decisive for the ease of use of the template model. The documentation shall make it possible for a Volvo Car Corporation colleague to study how to use the template model without aid of the model creator. This report is purposed to describe the project without the presence of the author.

# 4

## Project Work

This chapter presents the actual project work. The implementation of Ulrich & Eppinger's methodology is outlined as well as the outcomes of the various methods and tools. The content of the chapter extends from the project start (February 2017) until the refinement phase of the final concept (May 2017). The project time table can be seen in Appendix C

The initial task of the master's thesis was to develop a template of the high temperature radiator. The task was soon to be extended to include the complete cooler pack. The reason behind this extension was inputs from Cooling System Outer (B. Hansson, personal communication, March 7th 2017) that said that the packaging and development of the high temperature radiator were done as a package accompanied by some additional cooling components (the condenser, the fan and the low temperature radiator.). Therefore, the scope of the template was chosen to include the HTR, the fan, the condenser and the LTR.

### 4.1 Knowledge Acquisition

The first step of the project was to gain basic knowledge about the project topic. During this pre-study phase, three sub studies were done: a study of the cooling system, a study of the current packaging process of the cooler pack and a study about flexible modelling and CAD templates.

#### 4.1.1 Cooling System Study

The study of the cooling system was vital to reach a knowledge level to be able to create a CAD template of the cooler pack. The main source of information about the components was an internal Volvo Car Corporation document. In this document the cooling system and its components are technically described and e.g. lessons learned from previous projects are documented. For further gathering of data, meetings were held with the component responsible of each front cooler kit component. The need of studying the cooling system as a whole and each component individually was necessary to establish an understanding of the working principle of the system and the working principles of each component. The features of the components that should be included in the CAD template were identified and documented. The initial list can be seen in chapter 4.4.2. General information about the cooling system can be found in chapter 2.

### 4.1.2 Current Packaging Process of the Cooler Pack

The first step during the packaging process of the cooler pack is to create the model geometry. The size and the position of the components are governed by the needed cooling performance. The needed cooling performance is ruled by the type of propulsion system, engine power, component materials et cetera (Fredrik Tholander, personal communication, 2017-03-17). When the required cooling performance is provided to the responsible design engineer of the cooler pack, the geometry is created based on previous cooler packs with similar cooling performance. These models consist of the most space critical details and shapes of the cooler pack. During the packaging and development process more low-level details are added. The difference between the packaging model used during the early development phases and the final cooler pack can be seen in Figure 4.1

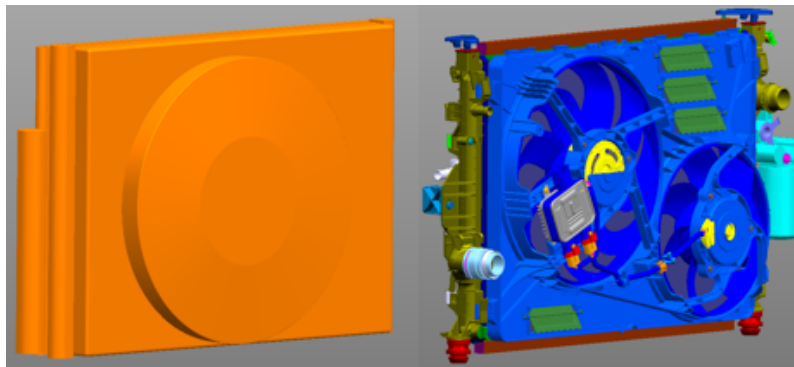

**Figure 4.1:** Comparison between a packaging model and the supplier final model of a cooler pack.

In Figure 4.1 it can be seen that during the early development phases very simplified geometries are used. The geometry of the cooler pack is continuously refined during the packaging and development phases until a suitable solution is identified. When a suitable solution is generated, suppliers are contacted. The suppliers provide models similar to the final packaging concept which is positioned at the targeted position in the car. The cooler pack CAD models have been created using the sketch-based approach. Since the cooler pack and its components need continuous redesigns until a suitable packaging solution can be found, a CAD template has been identified as a solution for decreasing the development and packaging time.

### 4.1.3 Flexible Modelling Study

A CAD template is developed by using flexible modelling methods. Before starting with the template development it was necessary to study how to create flexible CAD models. Therefore, the four day long Volvo Car Corporation course *CAD Advance. Flexible Modelling* was taken. The outcome of the course was valuable CATIA V5 knowledge that facilitated independent development work of the CAD template.



## 4.2 Customer Needs and Target Specifications

After finishing the pre-study of the cooling system a mission statement was compiled (see Appendix A). The main customer was identified to be the design engineer carrying out the early phase packaging study of the cooler pack. The secondary customers were identified to be the component responsible and Volvo Car Corporation engineers and managers involved in the packaging of the cooler pack during packaging meetings.

The next step of the process was to identify the needs of the different customers. The process of identifying the customer's needs was planned according to the four step process recommended by Ulrich & Eppinger:

1. Gather raw data from the customers
2. Interpret the raw data in terms of customer needs
3. Organize the needs into a hierarchy
4. Establish the relative importance of the needs

Meetings were held with design engineers who worked with the packaging of the cooler pack to gather raw data. It was made clear during these meetings that the benefits of creating a template of the cooler pack could not be perceived by the intended future users. The main reason for doubting the usefulness of a cooler pack template was because it is difficult to predict what needs to be changed during the packaging process (B.Hansson, personal communication, 2017-03-07). Due to the doubtfulness, no further customer inputs were provided by Cooling System Outer.

The needs of the secondary customers were known at project start (F. Bosch, personal communication, 2017-02-28). One main activity during packaging meetings is to discuss packaging collisions between different vehicle components. A recurring scenario is that one or more colliding components are in need of redesigns. One mean of increasing the efficiency and effectiveness of packaging meetings is to carry out redesign changes during packaging meetings. Therefore, they wanted a CAD model that could change its geometrical shape and position quickly. The model should be easy to use, because users with little CATIA V5 experience would use it.

A summary of the most vital customer needs are summarized in Figure 4.2. The complete customers needs list and the target specifications can be found in the Appendix B.

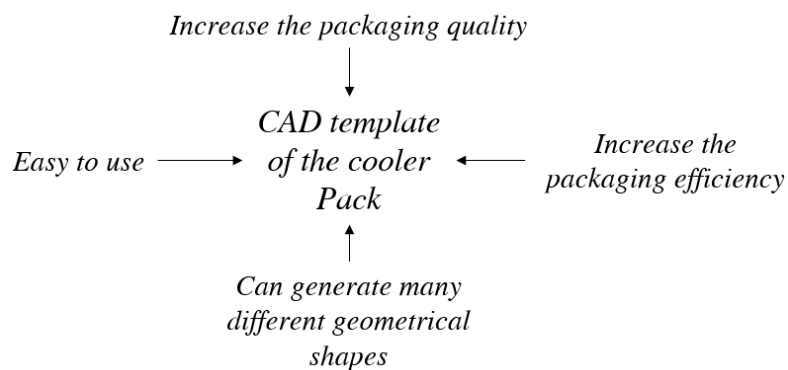

**Figure 4.2:** Main customer needs

As the customer needs were identified and the target specifications set, the concept generations was launched.

### 4.3 Concept Generation

During this phase the identified customer needs were translated into product concepts. The chapter is divided according to the used concept generation process:

1. Clarify the Problem
2. Search Externally
3. Search Internally

The concept generation phase is presented as a step-by-step approach, but during the actual project work many iterations had to be done.

#### 4.3.1 Clarify the Problem

A black box of the packaging and development process of the early phase development and packaging of the cooler pack was created (see Figure 4.3). This black box was used to achieve an overview of the packaging and development process. The process illustrated in the figure has been simplified for the sake of creating a good overview.

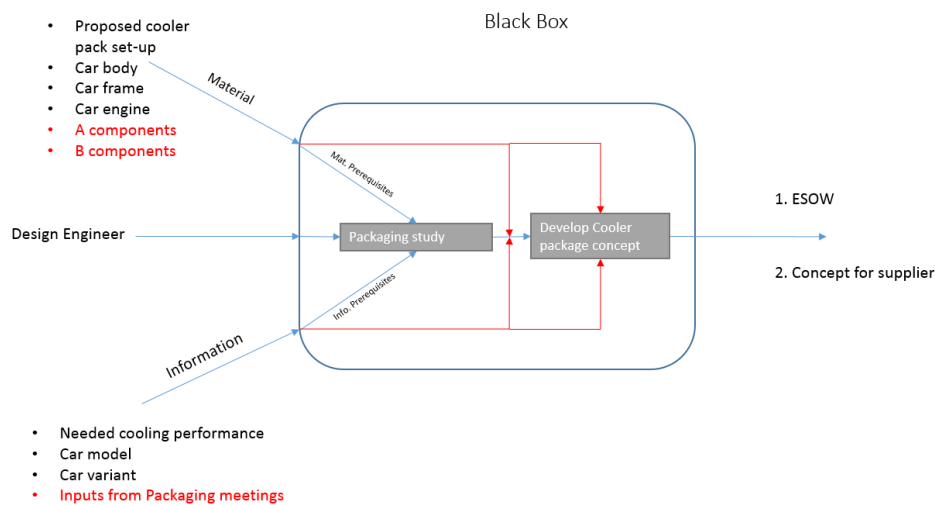

**Figure 4.3:** Black box of the early phase packaging and development of the cooler pack

During the packaging study the main challenge is to fit the cooler pack in the available space. As the number of components increases within the engine compartment, the space restriction during the packaging study is changed. The main problem to solve for this phase is to create a model that can quickly and easily be re-positioned and generate different geometrical shapes.

Before sending the ESOW (Engineering Statement of Work) the cooler pack concept is refined. In this stage it is important to increase the detail level of the cooler pack concept. The main problem for this phase is to generate all necessary geometrical information needed for a supplier to create a realizable cooler pack.

### 4.3.2 Search Externally

The search externally phase is an information-gathering process. It is beneficial to gather information by interviewing lead-users. Lead users are customers who experience the product, or process, more often than regular users. In this case the lead user was identified as the design engineer of the cooler pack. Due to the lack of interest in creating a CAD template of the cooler pack no further information was gathered from the lead user. Other methods for gathering inputs for problem solving is to *consult experts* and *benchmark related product*. Meetings were therefore held with colleagues from the CAD & Mechanical Development department at Volvo Car Corporation to gather inspiration from previous CAD templates. During these meetings previous CAD templates were studied together with the creators. The programming codes and the structures of similar CAD templates were documented. Examples of the parameter tree structure of a CAD template and one programming code can be seen in Figure 4.4.

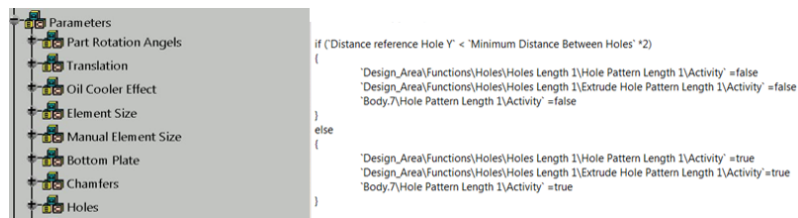

**Figure 4.4:** The parameter tree structure and one programming code of a CAD template

CAD & Mechanical Development shared relevant CAD templates which were continuously used during the project for solving of similar problems.

### 4.3.3 Search Internally

During this phase, also known as *the brainstorming phase*, the goal is to generate many ideas. The concepts generated in this phase are concepts of the complete cooler pack. Solutions for the separate features (e.g. spigots for in and out flow of the coolants) were generated during the system-level design phase, see chapter 4.6. The main focus of the concept generation was to identify a promising CAD model structure in order to make the CAD template fast and offer many different geometrical shapes. In order to generate a set of concepts the concept generation methods *brainstorming*, *make analogies*, and *wish and wonder* were used.

#### *Brainstorming*

During the brainstorming session numerous of 2D concepts were generated. The most promising were: Tot Rot, 6DoFs and 3DoF (see figure 4.5)

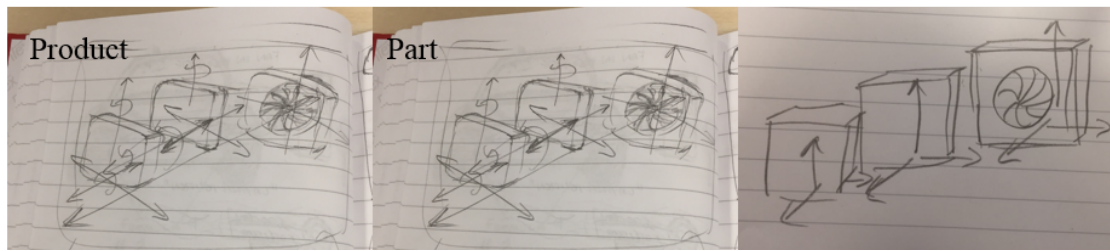

**Figure 4.5:** The Tot Rot, 6DoFs and 3DoFs 2D concepts

The *tot rot concept* is a product model in CATIA V5. This implies that the individual components (the HTR, the condenser, the LTR and the fan) are created as part models within the product model. The concept of using a product model for the CAD template creates very much flexibility of translating and rotating the individual cooling components. With a product model the translation and rotation of the components can be carried out with fast response. The main issue of using a product model for a CAD template is that the parameterization has to be done on the different model levels, i.e. both the product and all the part levels. This increases the risk of creating an unstable CAD template. An illustration of the concept can be seen in the left hand picture in Figure 4.5.

The *6DoFs concept* is a part model, which can be rotated and translated with six degrees of freedom, hence the name 6DoFs. The benefit is the six degree of freedom of positioning and rotating the cooler pack and the individual parts (HTR, condenser, LTR and fan). Creating the parameterization is simplified and more stable when all cooling components are included in one part model compared to a product model. The drawback is that the re-positioning becomes relatively slow when geometries within a part model can be translated and rotated with six degrees of freedom. An illustration of the concept can be seen in the middle picture in Figure 4.5.

The *3DoFs concept* is build up as a part model. Its build up as the 6DoFs concept, but the cooler pack and the cooling components can only be translated in three dimensions and not rotated. Hence, the name 3DoFs. The main benefit is that the model is faster to work with when the cooler pack or cooling components need to be translated. The reason for generating a concept that can be translated and not rotated is because the cooler pack has mainly been translated when re-positioned during earlier packaging studies. The benefit of only three degrees of freedom is that the model is faster compared to a fully rotational model, but the operation of rotating the model becomes more complex. An illustration of the concept can be seen in the right-hand picture in Figure 4.5.

### *Make analogies*

Making analogies is a concept generation method recommended by Ulrich & Eppinger to find solutions from other products that solve related problems. Following are the analogies that resulted in promising concepts of the cooler pack. In Figure 4.6 the concept inspired by a parking sensor system of cars can be seen.

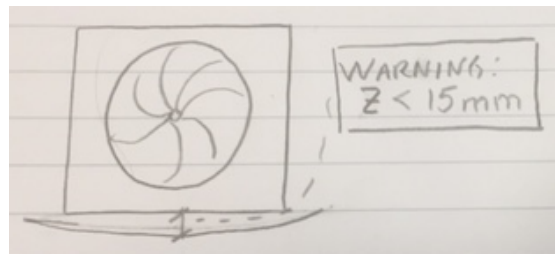
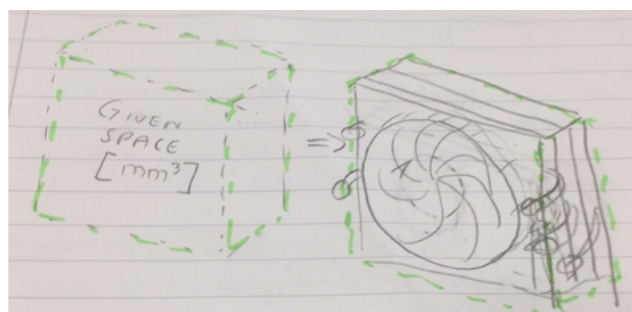

**Figure 4.6:** The Parking Sensor concept

The Parking Sensor concept increases the packaging quality by continuously informing the design engineer if the cooler pack's components are positioned with the required clearance to the surrounding components. The model can also inform if the individual cooling components have sufficient clearance to each other. The warning system is based on engineering know-how which shall be implemented in the coding of the model. By avoiding collisions, excessive redesign costs can be avoided in the late development phases. Additionally time savings are achieved because the design engineer does not have to continuously verify clearances. Additionally it warns if the required *restriction zones*, i.e. zones close to parts that requires extra space due to e.g. for maintenance or noise and vibration, are not given enough clearance.

Inspiration with help from an analog to the game Minecraft was gathered. In the game Minecraft the player build up a 3D world with square shaped building blocks. The building blocks possess very simple geometries, but by adding a big number of small building blocks a complex and detailed world can be created in the computer environment. The Minecraft game inspired to a concept. By coding a CATIA V5 model to enable the design engineer to add and re-position small building blocks, a cooler pack could be created. The small building blocks should be easy to use and fast to re-position. By adding and re-positioning the building block multiple geometrical concepts could be quickly generated. The Minecraft Concept was neglected by an external decision (Friedrich Bosch. Personal communication, 2017-04-03) before the first concept selection matrix was concluded. The reason for neglecting the concept was that building such a CATIA V5 concept would demand a very big model and it would make it very slow.

*Wish and Wonder* The concept generation wish and wonder is used to stimulate creativity by beginning a sentence with the words "I wish we could...". Its a fruitful method for identifying new possible solutions to the problem at hand. One concept that was generated with the wish and wonder method was the Packaging Pilot Concept (see Figure 4.7).



**Figure 4.7:** The Packaging concept

## 4. Project Work

The idea was generated from the comment "I wish we could create a CAD template that automatically creates a packaging solution". The imagined working principle is as follows: the concepts utilizes information regarding the available packaging space and automatically adapts the cooler pack's size and position to the given space. As the cooler pack is in the right position the spigots and other necessary details of the cooler pack are adjusted manually to create a suitable solution. In Figure 4.7 the dotted green lines shows the boundaries of the given space. In the right-hand picture the cooler pack has adapted its position and shape within the boundaries. By letting the model create the first packaging solution, time savings can be achieved.

The concepts Tot Rot, 6DoFs, 3DoFs, The Parking Sensor and the Packaging Pilot were brought into the concept selection phase.

### 4.4 Concept Selection

The next step after have generated a set of concepts was to identify the most promising one. During this phase the concepts were evaluated based on their strengths and weaknesses with respect to the customer needs. The selection process follows the two step process recommended by Ulrich & Eppinger:

1. Concept screening
2. Concept scoring

During the concept screening and the concept scoring the concepts are compared to each other in selection matrices.

#### 4.4.1 Concept Screening

During the concept screening phase the concepts are evaluated against a reference solution. For this project a previous early phase CAD model (see CAD model in the Figure 4.1) of the cooler pack was used. The concept-screening matrix can be seen in Figure 4.8.

Selection Criteria	Reference	Concepts				
		Tot Rot (Product)	6DoFs (part)	Parking Sensor (Part)	Packaging Pilot	3DoFs (Part)
1 All parts of the complete cooler pack are included	0	0	0	0	0	0
2 Packaging studies of the individual parts possible	0	0	0	-	0	0
3 Model designed for SPA models and CMA models	0	0	0	0	0	0
4 Model designed for GEN3 engines and BEV	0	0	0	0	0	0
5 Many different geometrical shapes can be created	0	0	0	0	0	0
6 Parts can change geometrical shapes quickly	0	+	+	-	0	+
7 Complete cooler can be translated quickly	0	0	+	-	+	+
8 Parts can be translated quickly	0	+	+	-	0	+
9 Multiple features can be added quickly	0	+	+	0	0	+
10 The features can be repositioned quickly	0	+	+	0	0	0
11 The shape of the features can be changed quickly	0	0	+	0	0	+
12 Additional parts can be added	0	0	0	0	0	0
13 Additional parts can be added quickly	0	0	0	0	0	0
14 Model is quality-simple	0	0	0	0	-	0
15 Know-how is build into the model	0	-	-	+	-	+
Sum +'s	0	4	6	1	1	6
Sum -'s	0	1	1	4	2	0
Sum 0's	15	10	8	10	12	9
Net score	0	3	5	-3	-1	6
Rank	4	3	2	6	5	1
Continue?		No	Yes	No	No	Yes

**Figure 4.8:** The concept-screening matrix

The winners in the concept-screening matrix were the 3DoFs and 6DoFs concept. The Tot Rot concept was ranked as third best concept but not decided to be further developed. This was based on an external decision (Friedrich Bosch. Personal communication, 2017-04-07). The reason for not continuing the development was that the concept was a Product model. Product models are less suited as CAD templates compared to Part models. From previous CAD templates it has been identified that the models become less stable. The Packaging Pilot was rejected due to the low score and the concept was found hard to realize. The Packaging Sensor scored the lowest score and was rejected. Though, the feature of informing if e.g. a part is positioned within a restriction zone was kept as an input for the development of the winning concepts.

#### 4.4.2 Refinement of the Winning Concepts

During this refinement stage the 6DoFs and 3DoFs concepts were created as 3D CAD models. The knowledge acquired from the *CAD advance - flexible modelling* course at Volvo Car Corporation was used to make the models flexible and stable. One main objective of this phase was to evaluate if a fully rotational model was more promising than an exclusively translatable model for the project. An initial list of all the details that the models should consist of was developed, see Table 4.1.

HTR	LTR	Condenser	Fan
Cooler Core	Cooler Core	Cooler Core	Fan Shroud
Coolant Tank x2	Coolant Tank x 2	Refrigerant tank x2	Fan Blades
Inlet Spigot	Inlet Spigot	Inlet Pipe	Speed Flaps
Outlet Spigot	Outlet Spigot	Outlet Pipe	
Bushings Upper x 2	Receiver	Dryer Bottle	
Bushings Lower x 2			

**Table 4.1:** Initial geometrical detail list

The CAD models were build up with rectangular block-shaped surfaces and cylindrical surfaces. Simple geometries were used to benefit fast geometrical changes. An example of one 3D concept can be seen in Figure 4.9.

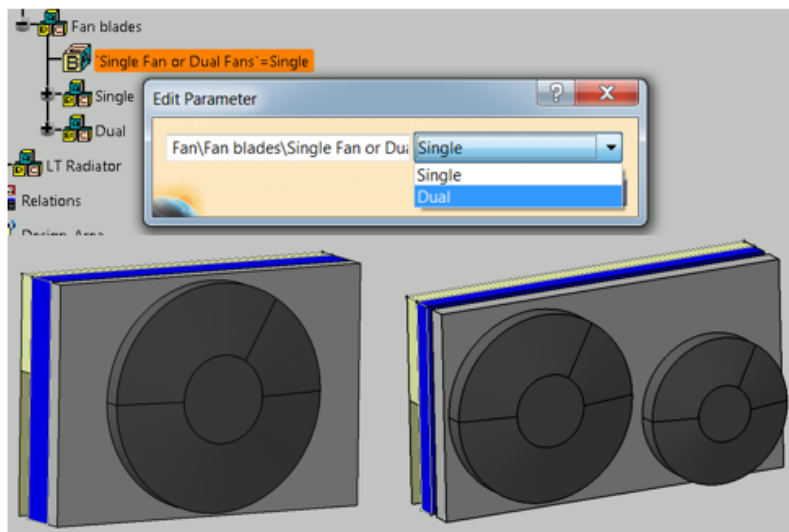

**Figure 4.9:** 3D concept. One or two fans can quickly and easily be alternated with the roll-down parameter

Coding the model in the Knowledge Advisor workbench was necessary to create such a roll-down parameter as shown in Figure 4.9. Much of the work during the creation of the 3D concepts was spent on coding the models. Coding knowledge acquired at Chalmers University of Technology from Matlab courses was useful, but it was time demanding to adapt to the programming language in CATIA V5. To overcome numerous coding barriers, previous CAD templates' codes were used as guidance during the creation of the necessary codes. The more the coding knowledge increased, the more useful parameters could be created. These parameters could be used to show restriction zones, e.g. the restriction zone under the receiver and dryer bottle and the NVH zones behind the fans. Know-how was built into the models by creating such parameters.

One of the main needs from the customers is that the CAD template should be easy to use. To address this need, user tests were done. These tests were done by having colleagues from other departments (e.g. Propulsion System Geometry and Fuel and SCR distribution) perform hypothetical packaging studies with the CAD template concepts. The inputs from the test participants were used to improve the user interface, which meant reordering, renaming or adding parameters. For further information about the user tests, see chapter 4.7.

The fully rotational and translatable 6DoFs concept can be seen in Figure 4.10. The degrees of freedom of the concept's parts and details made a big number of different geometrical combinations possible. Different rotation angles and positions (controlled by the parameters) of some spigots can be seen in Figure 4.10. In the right-hand picture also the restriction zones of the fan and the receiver and dryer bottle have been activated. The 3DoFs concept was designed with the same geometrical details as 6DoFs, but the rotations of the geometries were excluded.



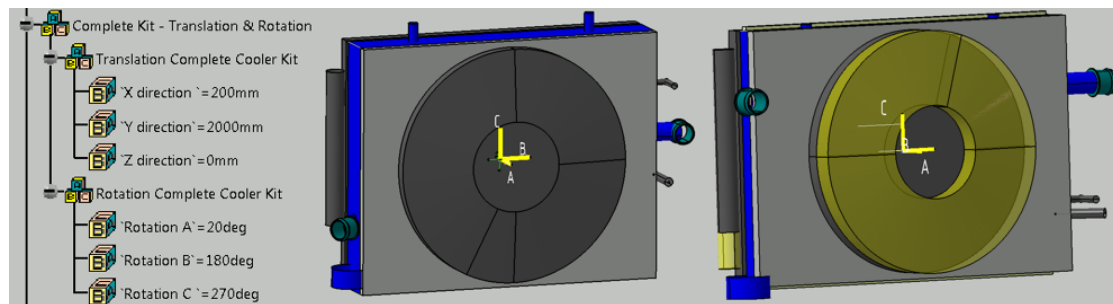

**Figure 4.10:** 3D concept of 6DoFs. Parameters for translation and rotation can be seen.

Following the creation of the two concepts as 3D models they were evaluated against each other in the concept-scoring matrix.

#### 4.4.3 Concept Scoring

The vital difference between the concept-screening matrix and the concept-scoring matrix is that each criteria is given a weighted number. This weighted number highlights the importance of the criteria. In the Figure 4.11 the concept-scoring matrix can be seen.

<i>Selection Criteria</i>		<i>Weight</i>	<i>Reference</i>		<i>Concepts</i>			
					<i>6DOFs</i>		<i>3DOFs</i>	
1	All parts of the complete cooler pack are included	5	5	25	5	25	5	25
2	Packaging studies of the individual parts possible	3	4	12	5	15	4	12
3	Model designed for SPA models and CMA models	5	3	15	5	25	5	25
4	Model designed for GEN3 engines and BEV	5	3	15	5	25	5	25
5	Many different geometrical shapes can be created	5	5	25	5	25	3	15
6	Parts can change geometrical shapes quickly	5	3	15	5	25	5	25
7	Complete cooler can be translated quickly	4	3	12	4	16	5	20
8	Parts can be translated quickly	5	2	10	5	25	5	25
9	Multiple features can be added quickly	3	3	9	4	12	4	12
10	The features can be repositioned quickly	5	3	15	5	25	5	25
11	The shape of the features can be changed quickly	5	2	10	5	25	5	25
12	Additional parts can be added	4	4	20	4	20	4	20
13	Additional parts can be added quickly	2	2	4	4	8	4	8
14	Model is quality-simple	5	3	15	5	25	5	25
15	Know-how is build into the model	5	3	15	5	25	5	25
		<b>Total Score</b>	<b>217</b>		<b>321</b>		<b>312</b>	
		<b>Rank</b>	<b>3</b>		<b>1</b>		<b>2</b>	
		<b>Continue?</b>			<b>Yes</b>		<b>No</b>	

**Figure 4.11:** The concept-scoring matrix.

The 6DoFs won because it had the possibility of generating a wider span of potential geometrical combinations. Since the possibility of generating many different geometrical shapes was a main need the 6DoFs concept was decided to be further developed in the testing and refinement phase. In this phase the concept was presented to the the main users, i.e. the design engineers of the cooler pack, for additional inputs.

## 4.5 Testing and Refinement

The phase started with a user test together with two design engineers who had previously worked with cooler pack development. The response was positive regarding the flexibil-

ity and ease of changing shapes and positions of the cooler pack. But, complaints were made regarding the geometrical shapes of the components (B. Hansson, personal communication, 2017-05-03). Instead of the simple rectangular shapes of the heat exchangers more detailed cross-sections were needed to create a useful CAD template of the cooler pack. In Figure 4.12 the cross-section in the z-direction of the 6DoFs concept and the new proposed cross-section design can be seen.

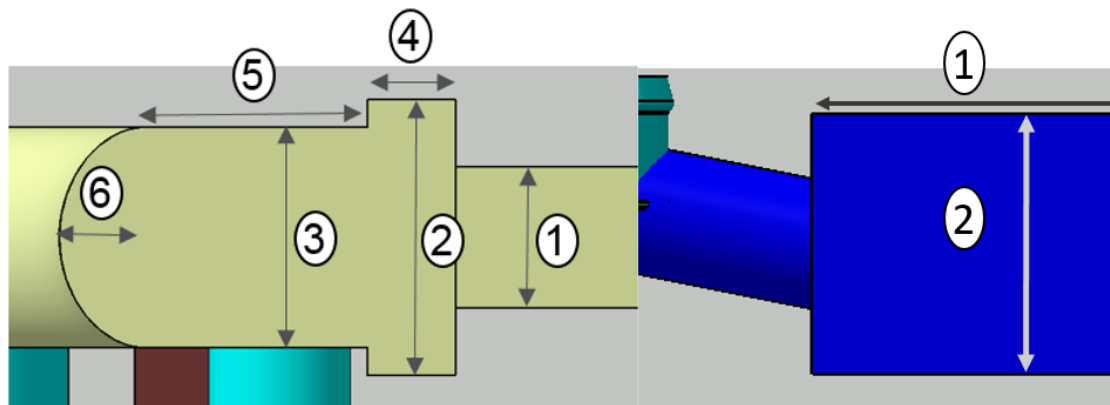

**Figure 4.12:** New (green) and old (blue) cross section design of the HTR.

After these user-tests the development focus of the CAD template was changed. The initial focus was to create a CAD template that could re-position its components and do redesigns quickly during the early packaging phases. The new development focus was to create a CAD template that could generate geometrical flexibility in the later packaging phases before a supplier was chosen. The main benefit of the new cross-section design is the possibility of easily evaluating multiple supplier designs. It was stated that big time savings could be achieved with the new cross-section design combined with parametrization.

Inputs were gathered regarding the number and types of geometrical details in the CAD template. The initial list, see Table 4.1, was extended. For example the holders keeping the fan in the right position should be included (K. Hansson, personal communication, 2017-05-03).

Discussions were also held regarding the rotation of the the cooler pack and its components. The output from these discussion were that the translation in the x-,y- and the z-direction were needed and that the rotation round the y axis was beneficial to include in the CAD template. The rotation around the y and z axes were seen as excessive. Therefore, the possibility of rotations around the y- and the z-axes were removed.

A new, final, concept was created based on the inputs from these user tests and discussions: the TailorMade concept. The name describes that the CAD template features are governed by the user inputs from the Cooling System Outer design engineers. The first 3D model of the HTR according to the new cross-section design can be seen in Figure 4.13.

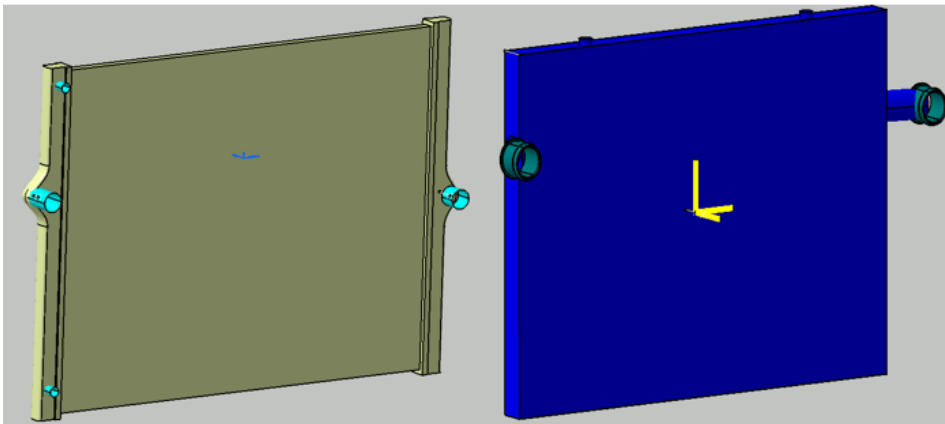

**Figure 4.13:** New HTR template design (green) and old HTR template design (blue)

The system-level design of the CAD template begun after the new user inputs had been gathered.

## 4.6 System-Level Design

The user inputs presented in chapter 4.5 were translated into product specifications and the initial detail list (see Table 4.1) was extended. In this system-level design chapter each component and its individual specifications and concept solutions are presented. The working procedure for each component has followed the same procedure;

1. the geometry was created
2. the parameters were added to the parameter tree
3. the coding between the geometry and the parameters was done
4. user tests were carried out to evaluate if adequate solutions had been created

The cooler components are presented in the following order: the high temperature radiator, the low temperature radiator, the condenser, and the fan.

### 4.6.1 High Temperature Radiator

The choice of geometries included in this high temperature radiator model has been based on which details of the HTR that are most space critical during the packaging study. The specifications list of the HTR model can be seen in Table 4.2.

#### *Cooler Core & Coolant Tanks*

The cooler core and coolant tanks were chosen to be designed according to the cross-section shown in Figure 4.12. The goal was to create the coolant tanks' geometry and parameter structure so that a user could easily alternate between different supplier inputs. A parameter-set was created in which all the lengths of the cross-section could be changed (see Figure 4.14).

#### 4. Project Work

Details	Parameters (geometry)	Parameters (Position)	Restriction Zone
Cooler Core	YES	NO	NO
Coolant Tank x2	YES	NO	YES
Inlet Spigot	YES	Y & Z	NO
Outlet Spigot	YES	Y & Z	NO
Bushings Upper x 2	YES	Y & Z	NO
Bushings Lower x 2	NO	NO	NO
Degas Spigot	YES	X & Y & Z	NO
Drainage Tap	YES	X & Y & Z	NO
Fan Holders	YES	Y & Z	NO

**Table 4.2:** HTR specification list

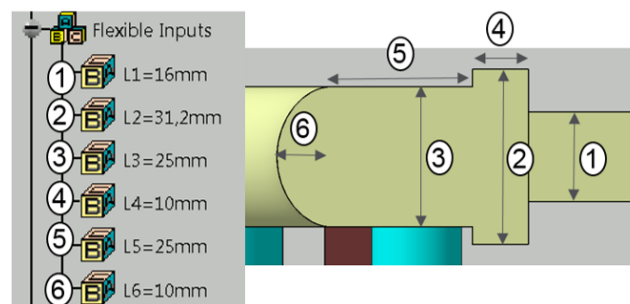

**Figure 4.14:** Parameter set of the coolant tank cross-section

The coolant tank needs a restriction zone because of the crimping operation when the cooler core and the coolant tanks are assembled together (B.Hansson, personal communication, 2017-05-03). The crimping operation requires a clearance to the geometries on the coolant tank. If any geometry is designed within this crimping restriction zone late design changes might be needed. Therefore, a surface which could be activated and deactivated for showing the restriction zone of the coolant tank was created. In the parameter set for the restriction zone the restriction zone surface can be activated.

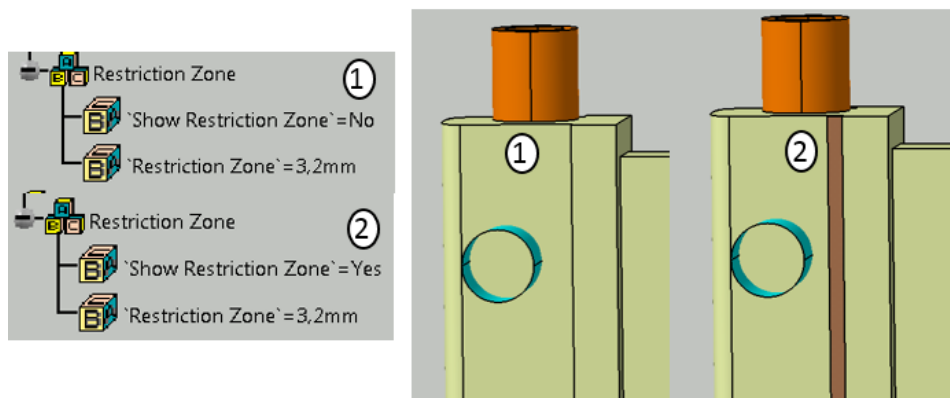
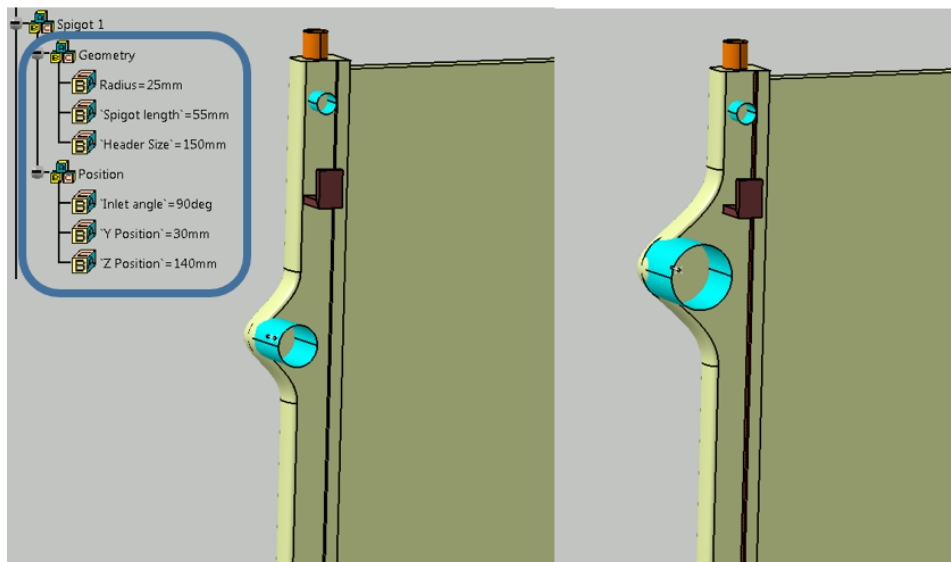

**Figure 4.15:** Restriction zone of the coolant tank

#### *Coolant spigots, degas spigot and drainage tap*

The position of the coolant spigots needs to be flexible. The spigots themselves are not

noticeable space requiring, but the coolant hoses that are connected to the spigots are very space requiring. Different spigot positions are evaluated before a position is found to which the coolant hoses can be routed. Therefore, the position of the coolant spigots needs to be flexible. Depending on the coolant flow the sizes of the spigots needs to be flexible (i.e. radius and length). One of the spigots can be seen in Figure 4.16. In the figure the parameters ruling the position and the parameters ruling the size of the spigot are shown.



**Figure 4.16:** Illustration of different spigot geometries with parameter input.

#### *The degas spigot and the drainage tap*

The geometry, the coding and the parameter structure of the degas spigot and the drainage tap are equivalent. The spigot and the tap are designed as cylindrical surfaces which can be translated in the y- and z-direction and with parameters for the radius and the length. To facilitate tests of positioning the degas spigot and drainage tap positions on the two coolant tanks of the radiator, a parameter was created which enables the user to quickly move the spigots to the opposite side. In Figure 4.17 this parameter and the two positions can be seen.

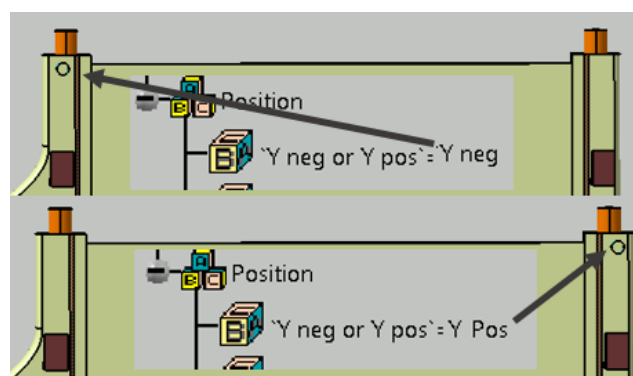

**Figure 4.17:** Degas spigot on the negative y-side of the radiator and on the positive y-side of the radiator.

### *The Bushings*

The bushings are necessary to include in a packaging study since they are the interface to the surrounding frames and car body. The packaging of the cooler pack with a included HTR is most probable to be made on a SPA platform. Therefore, the geometry of the current bushings for the SPA platform were used when creating the geometry of the bushings in the CAD template. In the Figure 4.18 one of the lower bushings can be seen. The bushings can be re-positioned in the y- and in the z-direction. The bushings shall be possible to re-position in these direction because the HTR can increase and decrease its width and be risen or lowered in the z-direction. The upper bushings for the SPA platform are cylinder shaped plastic parts. In the CAD template the upper bushings were therefore designed as cylinders with parameter driven length and radius. These orange colored cylinders can be seen in e.g. Figure 4.16.

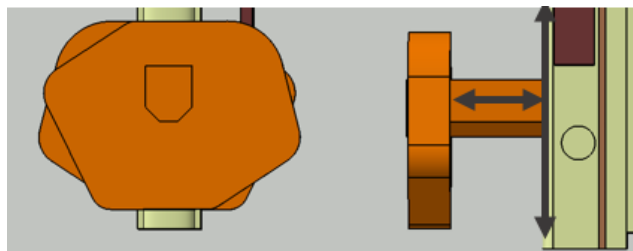

**Figure 4.18:** Bushing seen from the left side (in the driving direction) and from a rear view.

### *Fan Holders*

Numerous fans of previous cooler packs have been fastened to the cooler pack with four L-shaped plastic holders. The holders were decided to be included in the model because they are designed as a part of the coolant tanks, and therefore needs to be positioned without colliding with other parts as the coolant spigots and the degas spigot. In total four holders have been used. It was necessary to create parameters that could re-position the holders along the coolant tanks in the z-direction. In Figure 4.19 a commonly used holder designer and the template solution can be seen.

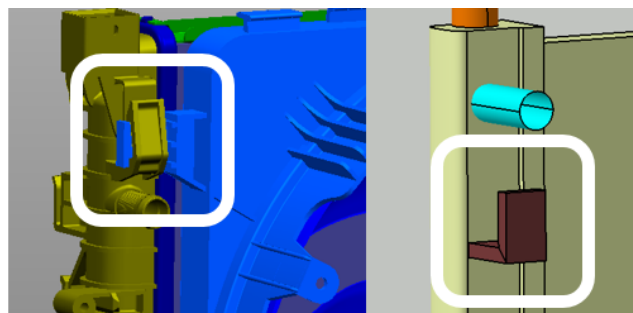

**Figure 4.19:** Production used holder and the template solution

Three different geometrical combinations of the complete HTR model can be seen in Figure 4.20.

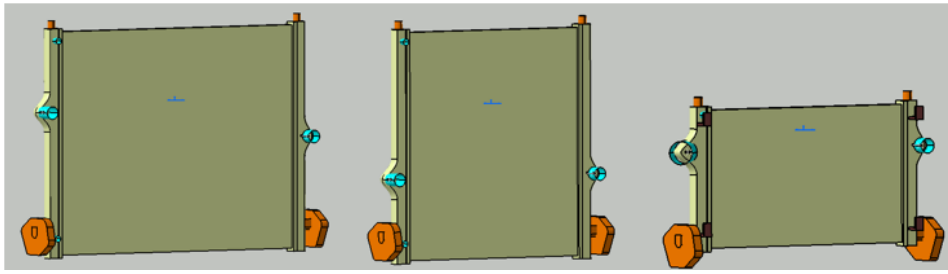

**Figure 4.20:** HTR geometries seen from the rear view in the driving direction

### 4.6.2 Low Temperature Radiator

The LTR specification list can be seen in table 4.3.

Details	Parameters (geometry)	Parameters (Position)	Restriction Zone
Cooler Core	YES	NO	NO
Coolant Tank x2	YES	NO	YES
Inlet Spigot	YES	Y & Z	NO
Outlet Spigot	YES	Y & Z	NO

**Table 4.3:** LTR specification list

The LTR was decided to be designed as the HTR. The difference being that the LTR was created with less details. The final solution can be seen in Figure 4.21.

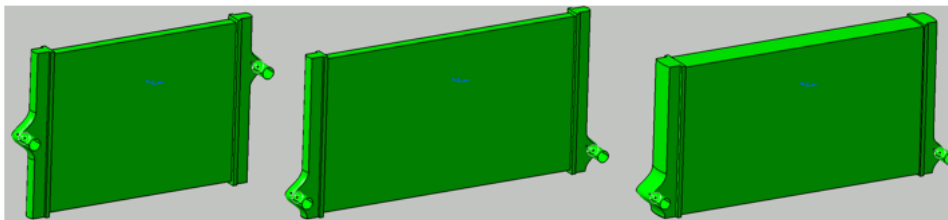

**Figure 4.21:** LTR geometries seen from the rear view in the driving direction

### 4.6.3 The Condenser

The choice of geometries included in the condenser model was the most space requiring and relevant ones for a packaging study. The list can be seen in table 4.4.

Details	Parameters (geometry)	Parameters (Position)	Restriction Zone
Cooler Core	YES	NO	NO
Refrigerant Tank x2	YES	NO	NO
Inlet Pipe	YES	Y & Z	NO
Outlet Pipe	YES	Y & Z	NO
Receiver & Dryer Bottle	YES	X, Y & Z + RZ	YES

**Table 4.4:** Condenser specification list

### *The Cooler Core & the Refrigerant Tanks*

During the discussions described in 4.4.2 it was decided that the cross-section in the z-direction of the condenser did not have to be designed as complex as the HTR's. An adequate packaging cross-section was identified to be a cooler core with a rectangular cross-section, and refrigerant tanks with a circular cross-sections. The sizes of the core and the refrigerant tanks needed to be flexible.

### *The Inlet & the Outlet Pipes*

These pipes connects the condenser with the AC system. Through the pipes the refrigerant flows that is used for cooling the air in the passenger compartment. When packaging these pipes it is important to be able to translate them upwards and downwards in the z-direction, and translate them in the y-direction. The size of the pipes shall be flexible, depending on the refrigerant flow. With these requirements the inlet pipe and the outlet pipe were created. The design of the pipes (see Figure 4.22) were created based on previous condenser models used in Volvo Cars' models. The pipes can be translated in the y- and in the z-direction. The radius of the pipes can be changed with parameters. Additionally, the pipes can be moved to the opposite side of the condenser by changing the value in a specific parameter. A connector has to be included in the geometry of one of the pipes. Know-how from previous projects were built into the parametrization of the connector. To reduce the risk of damage to the connector it has to have a certain angle to the horizontal plane. Therefore, a parameter controlling the connector angle was included in the model. The connector and the angle alpha can be seen in Figure 4.22.

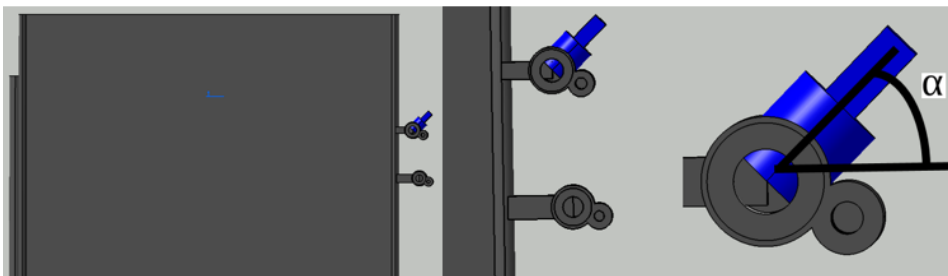
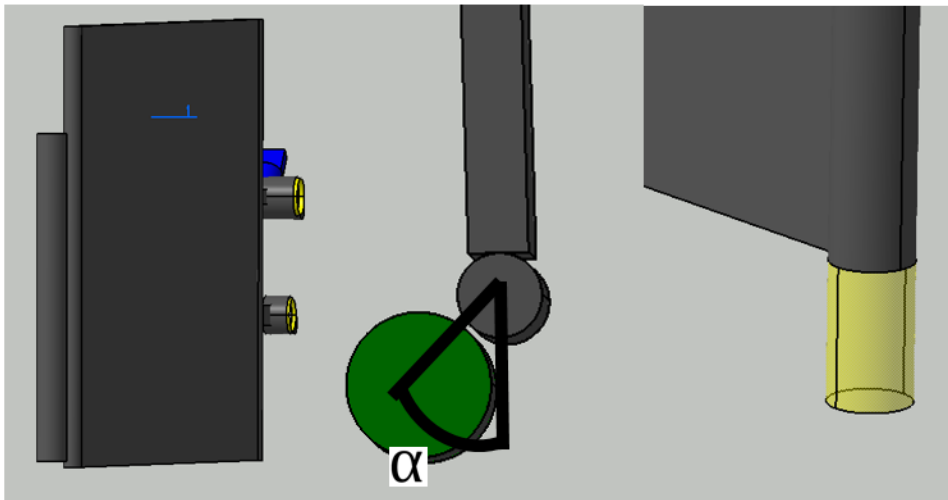

**Figure 4.22:** The complete condenser, the two refrigerant pipes and angle of the pressure sensor

### *The Receiver & Dryer Bottle*

The receiver and dryer bottle (RD bottle) has the function to remove harmful water from the AC system. The shape of the RD bottle was decided to be cylindrical. The mounting position should be along one of the refrigerant tanks of the condenser. With these inputs an geometry of the RD was created. The final solution was a cylindrical geometry which could be translated in the x- and y-direction and rotated around the z-axis. The height and the radius of the RD bottle could be changed with the model parameters. Know-how acquired during the pre-study (see chapter 4.1.1) regarding the RD bottle was applied. It was found during this study that some clearance to other components shall be left out under the RD bottle. This is because of maintenance reasons. During the lifecycle of the condenser, the RD bottle's dryer bag has to be changed. The dryer bag is commonly taken out from below of the condenser. A surface (yellow surface in Figure 4.23) representing this restriction zones was included in the model to reduce the risk of the user placing the RD bottle too close to a surrounding object. The RD bottle can be seen in Figure 4.23.





**Figure 4.23:** The RD bottle

#### 4.6.4 The Fan

The specification list of the fan can be seen in Table 4.5. It was important to make the

Details	Parameters (geometry)	Parameters (Position)	Restriction Zone
Fan Shroud	YES	NO	NO
Fan x 2	YES	YES	YES
Holders x 4	YES	YES	NO

**Table 4.5:** Fan specification list

fan shroud re-sizable in the y- and in the z-direction and make the radius and position of the fan flexible. Additionally a parameter was included that enables the user to switch between one or two fans. Three possible geometrical combinations with the fan can be seen in Figure 4.24.

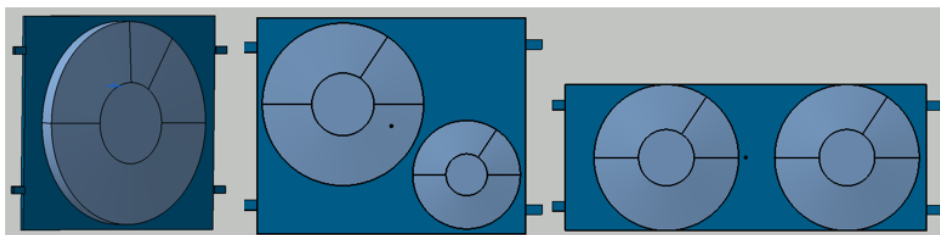

**Figure 4.24:** Different fan layouts.

The final concept of the complete CAD template is presented in chapter 5.1.

## 4.7 Design for User Experience

Design for user-experience was brought into all the concept development phases of the project. One of the main targets of this CAD template was to make it *quality-simple* [8].

A product that is quality-simple is complex, but is still easy to use. Getting the future users into the development process is necessary to achieve a quality-simple product. Every CAD template requires a learning curve before the user can understand the model. The purpose of creating a quality-simple CAD template was to make this learning curve as steep as possible in the beginning. Accordingly, during this project many CAD template prototypes were created in CATIA V5 and evaluated with user tests. From these user tests inputs for CAD template refinements were gathered. Building many prototypes and testing them with the future users is a methodology proposed by the designer Don Norman:

*"People don't know what they want. That is why it's important that we do this early work effectively, that we build a prototype, test it, and discover what the true requirements are. And then we do it again, and again, and again, each time, learning more and more what the concept needs to be"*

Quote by Don Norman [5]

Norman strongly recommends development teams to use this approach, because there is a tendency within development team to focus on the product technology itself rather than on the context of use. To avoid a main focus on the technology, user tests were done. Before the user tests started, a short introduction to the CAD template was presented. Following the presentation the participants received a to-do list. One of these to-do lists for the HTR can be seen in Figure 4.25.

### TASK LIST – HT RADIATOR

1. Find the parameter that translates the complete cooler pack in the x direction
2. Change the thickness of the HT radiator
3. Activate the inlet spigot of the HT radiator
4. Move the inlet spigot to a lower position
5. Move the inlet spigot to the top of the HT radiator
6. Change the inlet spigot type, and then change back to original type
7. Change the size of the inlet spigot

**Figure 4.25:** A to-do list used during an user test

After have done the user tests the participants were asked what the liked and disliked about the user-interface. For example some participant could have inputs on better naming of the parameters. Such a case is shown in Figure 4.26.



**Figure 4.26:** Inputs on naming of parameter and parameter value

Following the user tests all inputs were documented and the CAD template was continuously refined.

# 5

## Results

In this chapter the final concept of the CAD template is presented together with the validation of the customer needs.

### 5.1 Final Thesis Concept

The final CAD template concept can be seen in Figure 5.1.

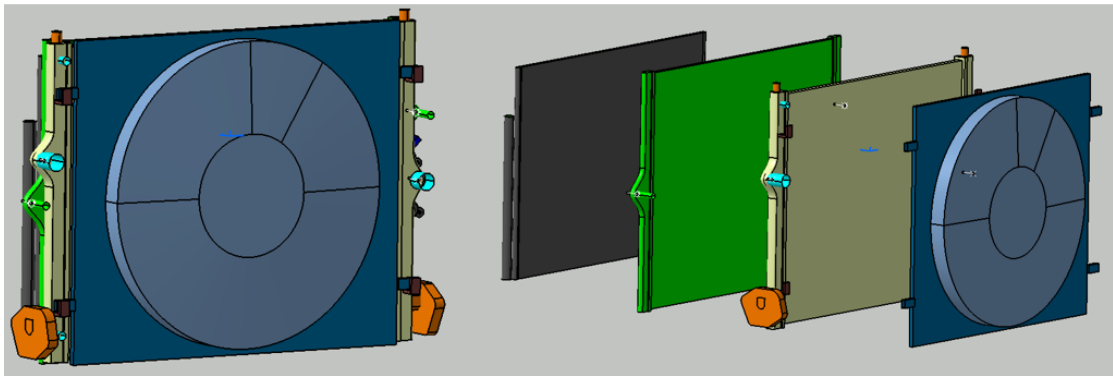

**Figure 5.1:** The final CAD template concept

The geometries of the parts can be moved independently to each other. The parts of the cooler pack can be activated and deactivated by using the parameters. This function enables packaging of four cylinder cooler packs (cooler pack combination in Figure 5.1) and BEV cooler packs (cooler pack combination in Figure 5.2).

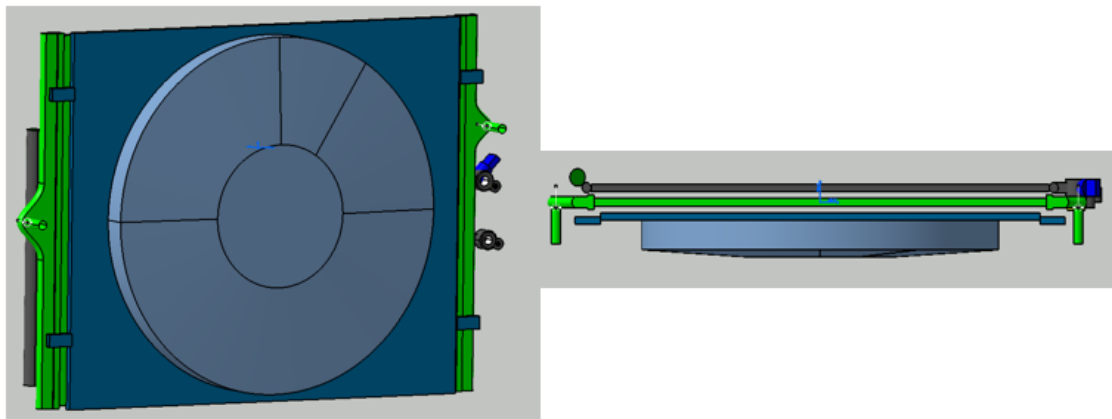

**Figure 5.2:** BEV cooler pack

In the next sub-chapter the validation of the customer needs are presented.

### 5.1.1 Customer Needs Fulfillment

In the Figure 5.3, the validated initial customer needs are shown.

	Need is met?
1 Do packaging studies with the complete cooler pack	YES
2 Do packaging studies with the individual heat exchangers	YES
3 Do packaging studies on different car models	YES
4 Do packaging studies for different propulsion systems	YES
5 Generate many different geometrical shapes	YES
6 Change geometrical shapes quickly	YES
7 Able to reposition complete cooler quickly	YES
8 Able to reposition sub cooling components quickly	YES
9 Able to add multiple features quickly	YES
10 Reposition the features quickly	YES
11 Change the shape of the features quickly	YES
12 Able to add additional components	YES
13 Able to add additional components quickly	NO
14 Model is easy to understand	YES

**Figure 5.3:** Fulfillment of the initial customer needs.

The only need that was not fulfilled was "able to add additional components quickly" (see Figure 5.3). The reason why this customer need is not addressed was due to inputs from the meetings and discussion described in chapter 4.5. The components included in the CAD template model are with a high level of certainty also the components that will be included in the final build to print model. Adding additional components are possible, but this operation does not have to be carried out quickly.

A customer need identified during the mentioned discussions was to provide the radiators with geometries which easily can be adapted to different supplier designs. The cross-section design (see Figure 4.14 in chapter 4.5) creates flexible radiator geometries for this need. An example of how the cross-section design is applied to multiple supplier input data is shown in Figure 5.4.

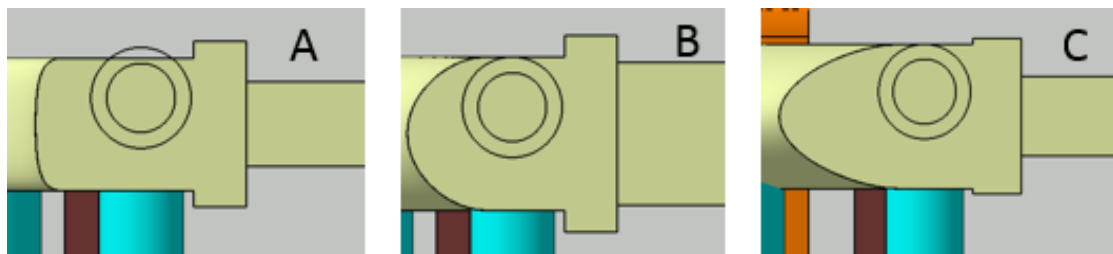

**Figure 5.4:** The 'supplier a', the 'supplier b' and the 'supplier c' cross-section designs

The final CAD template model was shown to colleagues at Cooling System Outer and they stated the potential of decreasing the packaging time and increasing the packaging

quality with the CAD template model.



# 6

## Conclusion and Recommendations for Future Work

In this chapter the conclusion of the master's thesis and the recommendations for future work are presented.

### 6.1 The Master's Thesis Conclusion

This master's thesis was purposed to answer the following two questions:

1. How can a CAD template be created of the front cooler pack that decreases the packaging time?
2. How can a CAD template be created that increases the packaging quality of the front cooler pack?

After having presented the final concept to numerous colleagues at Cooling System Outer it was stated that the CAD template was feasible for both decreasing the packaging time and increasing the packaging quality of the cooler pack. By enabling many possible geometrical shapes, and by building in engineering know-how in the CAD template the two targets could be achieved. The conclusion of the master's thesis output is that the project has fulfilled its purpose. But, there are some risks that might strongly reduce the usefulness and willingness to use the CAD template.

The first risk is that model consists of a set of defined components. If the type of components in the cooler pack are extended, the CAD template might not be designed for this or these kind of components.

A second risk is the willingness to use the template. The template's user-friendliness has continuously been improved during the project, but if a user does not find it user-friendly enough, the willingness to use it will be strongly reduced. These risks can be reduced by having the future users reading the CAD template's user guide.

The final conclusion is that the CAD template has to be aligned in a real packaging study to verify if it fulfills its purpose.

## **6.2 Recommendations for Future Work**

The true requirements of the CAD template were identified relatively late during the project. Due to the restricted time, all the user inputs were not implemented in the final concept. By continuing the collaboration work with the design engineers from Cooling System Outer, a feasible CAD template of the cooler pack can be achieved.



# 7

## Discussion & Lessons Learned

This chapter aims to present general reflections about the project topic, the project work and the lessons learned.

### 7.1 Relevance of the Task and the Objectives

Volvo Cars continuously improves their development efficiency and product quality. Reducing development costs and improving quality are some factors for the corporate success. The task that was done in this master's thesis is relevant for addressing these two targets.

### 7.2 Methodology

The working methodology was inspired of the development process proposed by Ulrich & Eppinger. Ulrich & Eppinger's development process was not fully applicable for this project. Their process are most suitable for physical products. Therefore, e.g. development phases connected to physical tests of the concepts or preparation phases for the manufacturing of the product was excluded in the master's thesis methodology. Since the development process could not be applied, Ulrich & Eppinger's work was used as a tool box. The development phases, and most of the various development methods, that could improve the quality of the master's thesis were applied. This is a recommendation for future master's thesis projects to study all the tools provided by Ulrich & Eppinger and test them, and use the ones that improve the development work. The main identified benefit of Ulrich & Eppinger's tools is the continuous focus on the customers. By successfully applying the tools and the methods, value for the end-user is created.

### 7.3 Lessons Learned

Cars are very complex products. They are built up by thousands of different parts. It is necessary to study the different systems to gain an understanding of the various working principles, requirements, technical performance et cetera. During the pre-study of this project much literature and internal documents were studied. Studying lessons learned from previous projects helped to create a good knowledge foundation about the cooling system. Along studying documents, meetings were organized with colleagues at Volvo Cars. Asking questions regarding the cooling system to the colleagues was very helpful. Asking questions to experts at Volvo Cars is a method that I will continue to use during

## 7. Discussion & Lessons Learned

---

my work at Volvo Cars. I recommend to do this to future master's thesis students. At Volvo Cars there are many experience people with valuable car knowledge. The best approach to reach this knowledge is by asking many questions and documenting the various answers.

The parametrization approach was seemingly new for me. Previously I have created CAD models with the sketch-based approach. The working efficiency that a parametrized CAD model creates has inspired me to continue to use this approach in my future development work. I would recommend Product Development at Chalmers University of Technology to extend widely the CATIA V5 education with feature knowledge.

# Bibliography

- [1] AC & Heating Connect. How Thermostatic Expansion Valves (TXV) work. Retrieved [2017-25-05] from <http://www.ac-heatingconnect.com/how-thermostatic-expansion-valves->
- [2] Catia "Knowledge Advisor". Retrieved [2017-05-08] from [http://www.catia.com.pl/tutorial/z2/knowledge\\_advisor.pdf](http://www.catia.com.pl/tutorial/z2/knowledge_advisor.pdf)
- [3] Dassault Systems "Shape Design & Styling Solutions". Retrieved [2017-05-08] from [https://www.3ds.com/products-services/catia/products/v5/portfolio/domain/Shape\\_Design\\_Styling/](https://www.3ds.com/products-services/catia/products/v5/portfolio/domain/Shape_Design_Styling/)
- [4] Cengel, YA., Turner, RH., & Cimbala, JM (2008). *Fundamentals of Thermal-Fluids Sciences* (3rd ed). New York: McGraw-Hill.
- [5] Euchner, Jim (2016). *Design For Use: An Interview with Don Norman Research Technology Management; Arlington* Retrieved [2017-04-25] from <http://escholarship.org/uc/item/73f3p072#page-6>
- [6] Harvard Business Review. *Lean Knowledge Work*. From the October 2011 issue. Retrieved [2017-05-25] from <https://hbr.org/2011/10/lean-knowledge-work>
- [7] Learn Engineering. *Working of Refrigerator & Refrigeration Principle*. Retrieved [2017-25-18] from <http://www.learnengineering.org/2014/04/working-of-Refrigerator.html>
- [8] Mollerup, Per (2015). *Simplicity a matter of design*. Amsterdam: BIS Publisher.
- [9] Technology Student (2013). *What is market pull?* Retrieved [2017-02-23] from <http://www.technologystudent.com/prddes1/marketpull1.html>

## Bibliography

---

- [10] Ulrich, K. T., & Eppinger, S. D. (2012). *Product Design and Development*. New York: McGraw-Hill Irwin.
  
- [11] Volvo Car Corporation (2017) "Our company at a glance".  
Retrieved [2017-05-08] from <http://www.volvocars.com/intl/about/our-company/our-company-at-a-glance>
  
- [12] Volvo Cars (2017) "Core Values. The Volvo Way."  
Retrieved [2017-05-31] from <http://www.volvocars.com/intl/about/our-company/our-company-at-a-glance/core-values>

# A

## Mission Statement

Product Description	Flexible CAD model (template) of the front cooler kit for early phase development
Benefit Proposition	<ol style="list-style-type: none"><li>1.Enable faster changes among numerous different geometrical shapes and positions</li><li>2. Increase packaging maturity during the early phases</li></ol>
Key business goals	<ol style="list-style-type: none"><li>1. Reduce cooling system development time</li><li>2. Increase cooling system development quality</li></ol>
Primary market	Engineer performing the packaging study of the front cooler kit
Secondary market	Employees participating in packaging study, e.g. during packaging meeting
Assumptions	<ol style="list-style-type: none"><li>1. Usage during early development phases (pre FC0)</li><li>2. The cooling components in “front cooler kit” are packaged as one unit</li></ol>

## A. Mission Statement

---

# B

## Customer Needs List & Target Specifications

Geometrical Packaging needs:	Relative Importance
<b>Do packaging studies with the complete cooler pack</b>	<b>5</b>
Do packaging studies with the individual sub cooling* components	3
Do packaging studies on different car models	5
<b>Do packaging studies for different propulsion systems</b>	<b>5</b>
<b>Generate many different geometrical shapes</b>	<b>5</b>
<b>Change geometrical shapes quickly</b>	<b>5</b>
Able to reposition complete cooler quickly	4
<b>Able to reposition sub cooling components quickly</b>	<b>5</b>
Able to add multiple features quickly	3
<b>Reposition the features quickly</b>	<b>5</b>
<b>Change the shape of the features quickly</b>	<b>5</b>
Able to add additional components	4
Able to add additional components quickly	2
<b>Model is easy to understand</b>	<b>5</b>
<b>Model increases the packaging quality</b>	<b>5</b>

**Figure B.1:** List of the identified customer needs. 5 = high importance. 1 = low importance

CAD template specifications	Relative Importance
<b>All parts of the complete cooler pack included</b>	<b>5</b>
Packaging studies of the individual parts possible	3
Model designed for SPA models and CMA models	5
<b>Model designed for GEN3 engines and BEV</b>	<b>5</b>
<b>Many different geometrical shapes can be created</b>	<b>5</b>
Parts can change geometrical shapes quickly	4
Complete cooler can be translated quickly	4
<b>Parts can be translated quickly</b>	<b>5</b>
Multiple features can be added quickly	3
<b>The features can be repositioned quickly</b>	<b>5</b>
<b>The shape of the features can be changed quickly</b>	<b>5</b>
Additional parts can be added	4
Additional parts can be added quickly	2
<b>Model is quality-simple</b>	<b>5</b>
<b>Know-how is build into the model</b>	<b>5</b>

**Figure B.2:** Target specifications

## B. Customer Needs List & Target Specifications

---



# C

## Project Time Table

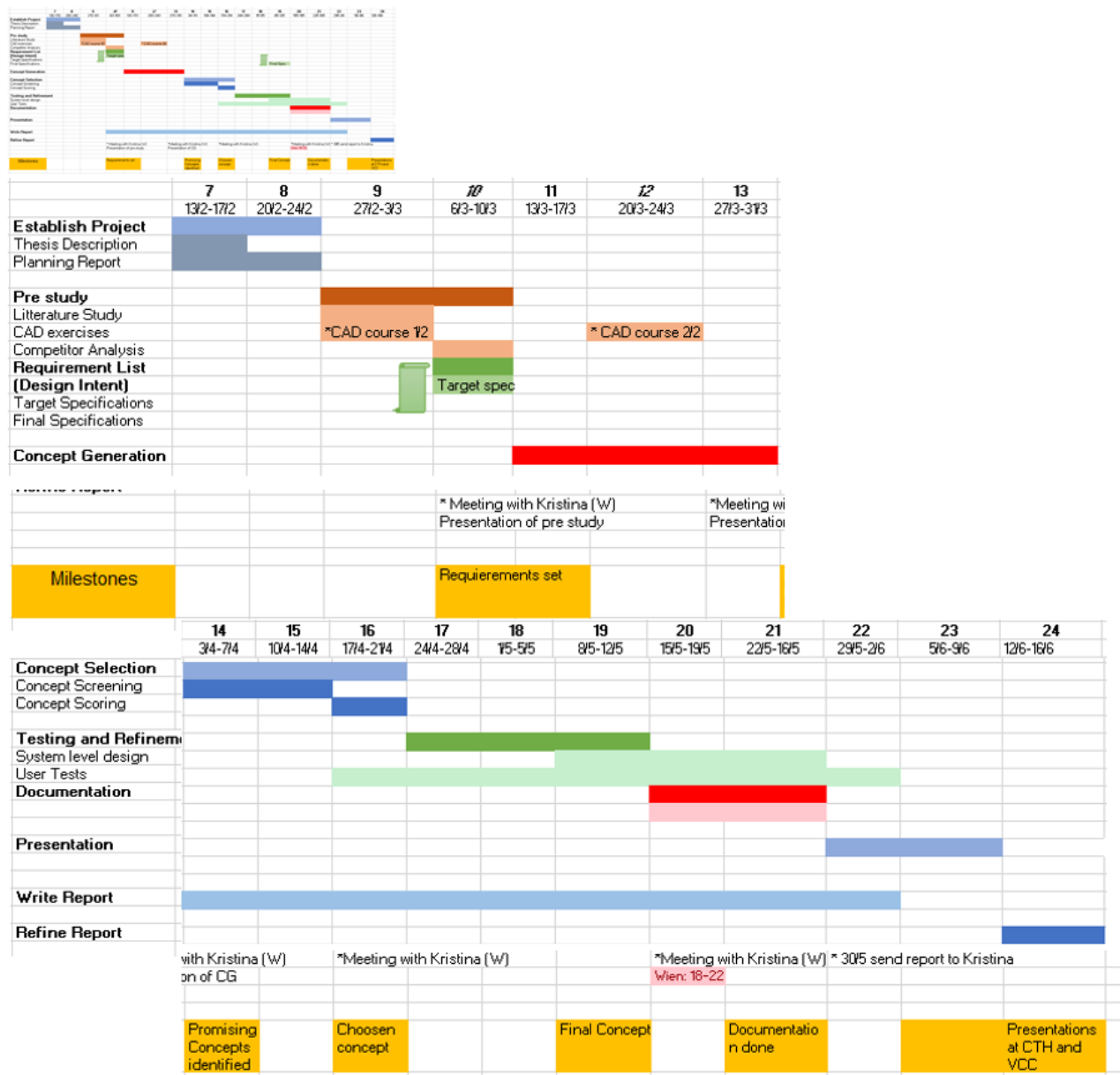

Figure C.1: Project Time Table