

# CHALMERS



## Development and Integration of a Post Impact Control Function for Passenger Vehicles

*Master's Thesis in Automotive Engineering*

**YONGWEI GAO, MENG YAO**

Department of Applied Mechanics  
*Division of Vehicle Engineering and Autonomous Systems*  
*Vehicle Dynamics Group*  
CHALMERS UNIVERSITY OF TECHNOLOGY  
Göteborg, Sweden 2014  
Master's thesis 2014:25



MASTER'S THESIS IN AUTOMOTIVE ENGINEERING

Development and Integration of a Post Impact Control  
Function for Passenger Vehicles

YONGWEI GAO, MENG YAO

Department of Applied Mechanics  
*Division of Vehicle Engineering and Autonomous Systems*  
CHALMERS UNIVERSITY OF TECHNOLOGY  
Göteborg, Sweden 2014

Development and Integration of a Post Impact Control Function for Passenger Vehicles

YONGWEI GAO, MENG YAO

© YONGWEI GAO, MENG YAO, 2014

Master's Thesis 2014:25

ISSN 1652-8557

Department of Applied Mechanics

Division of Vehicle Engineering *and Autonomous Systems*

Chalmers University of Technology

SE-412 96 Göteborg

Sweden

Telephone: + 46 (0)31-772 1000

Chalmers Reproservice / Department of Applied Mechanics  
Göteborg, Sweden 2014

Development and Integration of a Post Impact Control Function for Passenger Vehicles  
Master's Thesis in *Automotive Engineering*  
YONGWEI GAO, MENG YAO

Department of Applied Mechanics  
Division of Vehicle Engineering *and Autonomous Systems*  
Chalmers University of Technology

## ABSTRACT

The thesis further develops a Post Impact Stability Control (PISC) function so as to improve the performance to avoid multiple-event accidents. The function is integrated in a vehicle dynamics control architecture. The high-level control target is set to minimize the maximum lateral deviation from the initial desired path. This is achieved by integrating an active steering control strategy with the existing electronic stability control function (ESC). The control task is realized by active control of front steering angle and individual wheel braking.

The integrated PISC function is verified across various post-impact kinematics conditions, using a high-fidelity vehicle simulation model in CarMaker<sup>®</sup>. A vehicle states estimator is designed using a simplified 3-DOF two-track vehicle model. This estimator is essential for testing real-time implementation concepts. It was found that a well-estimated vehicle lateral velocity is important to guarantee a well-performed PISC function. The controller is also compared favourably to the other benchmark functions, i.e. PIB and PISC(without integration of ESC).

Towards real-time implementation, two active steering configurations are simulated: Steer-by-Wire and Electronic Power Assist Steer (EPAS). It was found that the control performance is generally not sensitive to the steering actuators. However, increased limit of steering torque overlay is shown to improve the minimization of lateral derivation, without introducing control instability.

Keywords: Vehicle Dynamics, Post Impact, Path Control, Multiple-Event Accidents, Active Safety, Electronic Stability Control.



# Contents

Abstract.....	I
Contents .....	III
Preface.....	V
Notations .....	VI
1 Introduction.....	1
1.1 Background.....	1
1.2 Objective.....	1
1.3 Literature Review.....	2
1.3.1 PISC-relevant functions.....	2
1.3.2 ESC functions .....	3
2 Vehicle Model.....	4
2.1 General description .....	4
2.1.1 Steering actuation.....	6
2.1.2 Brake actuation .....	7
2.2 Description of relevant functions.....	8
2.2.1 PISC function.....	8
2.2.2 ESC function.....	9
2.2.3 ABS function .....	12
2.2.4 PIB function .....	14
2.3 Vehicle State Estimator.....	15
2.4 Function Integration.....	16
2.4.1 PISC with vehicle states from model.....	17
2.4.2 PISC with estimated vehicle states .....	18
2.5 Post-impact initial condition set-up in CarMaker .....	19
3 Function Performance .....	22
3.1 Different configuration exploration .....	22
3.1.1 Comparison between PISC CM and PISC+ESC CM.....	23
3.1.2 Comparison between PISC CM and PISC Est.....	25
3.1.3 Comparison between PISC Est and PISC+ESC Est .....	28
3.2 Improve estimates of vehicle states .....	30
3.2.1 Comparison between PISC Est and PISC+ESC Est (improve $v_y$ estimate).....	31
3.3 Final model performance evaluation .....	32
3.3.1 ESC K value influence.....	32

3.3.2 $\lambda$ 's influence .....	34
3.4 Verification with on-board systems .....	36
3.4.1 Performance when work with EPAS system .....	36
3.4.2 Replace simplified ESC with commercial ESC.....	38
3.4.3 Compare with PIB function .....	39
3.4.4 Real signal update frequency .....	40
4 Test Matrix.....	42
5 Conclusion .....	48
6 Future Work.....	49
Reference .....	50
Appendix.....	51
Appendix A: PISC function in Simulink .....	51
Appendix B: ESC function in Simulink .....	52
Appendix C: PISC function further explanation.....	53



## Preface

This project has been carried out at Vehicle Motion Control group at Active Safety & Vehicle Dynamics Function department at Volvo Car Corporation and division of Vehicle Engineering and Autonomous Systems at Chalmers University of Technology, in Göteborg during the spring of 2014. The work is based on the previous studies on Post Impact Stability Control by Dr. Derong Yang from Chalmers University of Technology.

We would like to thank our supervisor Dr. Derong Yang at Volvo for the excellent guidance through the thesis. Her inspirational discussions on the topic benefit us a lot. We also thank our supervisor and examiner Professor Bengt Jacobson at Chalmers, for his generous support and precious instructions on the writing of the thesis. Many Thanks to Dr. Mats Jonasson at Volvo for his invaluable help during the development of thesis. We also thank CarMaker® software and Modelon for their kind and patient technical support.

## Notations

$C_{a,f}$ : Cornering stiffness of front axel [N/rad]  
 $C_{a,r}$ : Cornering stiffness of rear axel [N/rad]  
 $I_{zz}$ : Moment of inertia around z axle in vehicle coordinate [kg m<sup>2</sup>]  
 $L$ : Distance from front axel to rear axel [m]  
 $F_x$ : Longitudinal force [N]  
 $F_y, F_{yg}$ : Lateral force [N]  
 $F_z$ : Vertical force [N]  
 $M_z$ : Yaw moment [Nm]  
 $Y$ : Global lateral displacement [m]  
 $Y_0$ : Initial value of global lateral displacement [m]  
 $Y_{\max}$ : Maximum global lateral displacement [m]

$g$ : Acceleration of gravity [m/s<sup>2</sup>]  
 $l_f$ : Distance from front axel to center of mass [m]  
 $l_r$ : Distance from rear axel to center of mass [m]  
 $m$ : Mass of vehicle [kg]  
 $r$ : Yaw rate [rad/s]  
 $t_f$ : the time when maximum path deviation ( $Y_{\max}$ ) occurs [s]  
 $t_{f0}$ : Estimate value of  $t_f$  [s]  
 $v_x$ : Longitudinal velocity of vehicle, in vehicle coordinate directions [m/s]  
 $v_y$ : Lateral velocity of vehicle, in vehicle coordinate directions [m/s]  
 $w$ : Half of axle width [m]

$\alpha_1$ : Front tyre slip angle (bicycle model) [rad]  
 $\alpha_2$ : Rear tyre slip angle (bicycle model) [rad]  
 $\delta$ : Steering angle [rad]  
 $\lambda$ : Control Parameter in PISC function  
 $\mu$ : Friction coefficient of road [-]  
 $\psi$ : Yaw Angle [rad]

## Abbreviations

ABS: Anti-lock braking system  
EPAS: Electronic Power Assist Steering  
ESC: Electronic Stability Control  
PIB: Post Impact Brake  
PIC: Post Impact Control  
PISC: Post Impact Stability Control  
PISC CM: only PISC using true vehicle states  
PISC Est: only PISC using estimated vehicle states  
PISC + ESC CM: PISC and ESC function using true vehicle states  
PISC + ESC Est: PISC and ESC function using estimated vehicle states



# 1 Introduction

Vehicle traffic safety has been attracting considerable attention with an increasing amount of accidents registered in road traffic data system. Accident statistics showed that about 30% of passenger car accidents are multiple-event accidents (MEAs), which is characterized by having at least one vehicle subjected to more than one harmful event, such as collision with another vehicle or object (Yang D., Jacobson B., Lidberg M., 2009). Compared to single-event accidents, MEAs could lead to higher possibility of severe injuries.

Current Electronic Stability Control (ESC) systems are well designed for vehicle yaw motion control due to aggressive driving maneuvers, but not for the vehicle after external disturbances. Thus, a vehicle safety function – Post Impact Stability Control (PISC), is developed to avoid or mitigate the subsequent events after an initial impact.

## 1.1 Background

When a vehicle crash occurs, it's common that the vehicle tends to lose control, due to its high yaw rate and sideslip. In such an unstable condition, the driver usually can't react quickly enough to control the vehicle, or maybe even make it worse due to severe anxiety and disorientation. Thus, within a very short time window, the second impact may happen in the case that the vehicle collides subsequently with the road-side object, or another vehicle. A severer injury or death may happen in the following collisions, since by then the airbags have been probably deployed, and buffer zone has been compromised. It's found that a significant portion of car accident has more than one impact in an accident, which is defined as multiple-event accidents (MEAs).

A previous study on potential benefits gained from post impact interventions showed that if lateral deviations can be reduced, in many cases it is possible to mitigate or completely avoid secondary events (Yang D., 2009). Therefore, the ability to minimize the post impact path lateral deviation can be greatly beneficial to road traffic safety, provided significant controlled changes in path are feasible.

Based on this control target, the Post-Impact Stability Control (PISC) function is designed to control the vehicle path after impact. By minimizing the global lateral displacement of vehicle, PISC could limit the vehicle deviation from the original route largely, hence reduce the possibility of secondary impacts.

## 1.2 Objective

The thesis aims to further develop and simplify a PISC function so as to improve the vehicle performance to avoid multiple-event accidents in real world. Its performance is to be evaluated by integrating with other vehicle dynamics control functions, such

as ESC and ABS. The controllers are implemented in real-time simulation environment, across a large range of post-impact kinematics conditions. The results are compared with current PIB function.

## 1.3 Literature Review

Literatures of relevant functions for the present thesis work, i.e. PISC, ESC and PIB are studied. The function design varies with different control targets.

### 1.3.1 PISC-relevant functions

In Yang D., 2013, PISC function is introduced in order to reduce the probability and severity of secondary impacts after an initial one. Traditional sensors of passive safety systems such as airbags sensors can be used to trigger the function.

A number of MEAs were analyzed from an accident database, and it's found that reduction of kinetic energy and path lateral deviation are most critical and beneficial for the vehicle after impacts.

In her thesis, numerical optimization was used to minimize the maximum path lateral displacement. It's found that, besides individual wheel braking, active front-axle steering provides great control benefits, not for all conditions, but it expands the control range in which coupled control of yaw moments and lateral forces is the most effective control strategy, with respect to both vehicle stability and path control.

A quasi-linear optimal controller (QLOC) was then proposed to minimize the path lateral deviation. This closed-loop design of path control is verified with the open-loop numerical optimization results. QLOC uses a generalized cost function and calculates the trade-off between global lateral force and yaw moment. The applicability and robustness of QLOC is confirmed with a more computationally efficient design in multi-body vehicle model.

Another thought about post impact control is Post Impact Braking (PIB), which simultaneously applies ABS-braking or partial braking on all four wheels, in order to prevent or mitigate a subsequent impact when a vehicle has been involved in a collision. After a collision that induces acceleration higher than a certain threshold, the PIB function is triggered and decelerates the car to zero speed state and holds it stationary. Also, it can be overwritten if the driver presses the acceleration pedal hardly, the car will stop braking. (Kusachov A., Mouatamid F., 2012).

PIB reduces vehicle longitudinal speed significantly with low request for sensors. On the other hand, potential hazard remains, e.g. deviation from original lane thus collision with other vehicles or road-side objects. However, since PIB is easy to realize, this type of secondary collision brake assist systems is now emerging on the market e.i. Audi secondary collision brake assist (EURO NCAP, 2014, Audi), and VW Multi Collision Brake (EURO NCAP, 2014, VM).

### 1.3.2 ESC functions

ESC is an active safety technology that assists the driver to keep the vehicle within the stability region, and thereby assist the driver in controlling the vehicle in order to avoid accidents. ESC follows the driver's intended yaw rate within the limits of various stability criteria, by active braking and steering (even active suspension) which redistribute the tyre longitudinal and lateral forces, so as to improve vehicle handling performance near the limit of tyre-road adhesion. It is especially effective in keeping the vehicle on the road and mitigating rollover accidents which account for over 1/3 of all fatalities in single vehicle accidents (Liebemann E.K., 2004).

Stabilizing a vehicle in critical situations is challenging. Considering the physical effects, steering of a vehicle yields in a yaw moment which results in a directional change, while the effect of a given steering angle depends on the actual side slip angle. Only slight alterations of the yaw moment are possible at large side slip angles even for extensive steering. At this time, when the effectiveness of steering is rather limited, ESP can exercise remarkable yaw moments by brake interventions. (Liebemann E.K., 2004).

ESC not only initiates braking intervention, but can also reduce engine torque to slow the vehicle. If the vehicle moves in a different direction, ESC detects the critical situation and reacts immediately. So within the limits of physics, the car is kept safely on the desired path (Bosch Automotive Technology, 2014).

In Naraghi M, Roshanbin A., Tavasoli A., 2009, the controller uses the (desired) yaw rate and side-slip angle as inputs in order to compute the total yaw moment and lateral force required to control a simplified 2DOF vehicle (known as a bicycle model). In order to distribute the total yaw moment and lateral force between the tyres, an adaptive optimal approach is introduced where the longitudinal and lateral forces to be generated by each wheel are determined. In this way, the desired yaw rate and sideslip angle can be followed.

In conditions of aggressive driver maneuvers, side-winds and uneven tyre frictions, ESC function has been proven that it works well to keep the path. However, ESC may be deactivated in case of impact. On one hand, vehicle state after impact is so severe that it is out of ESC operation range. On the other hand, driver is possibly unable to act correctly to control vehicle. So a special controller needs to be developed to keep vehicle stable during and after impact.

## 2 Vehicle Model

The model used in this thesis is based on CarMaker 4.05 version. CarMaker is software for integrated development of concepts, models, control systems and components in vehicles. It is especially suited for the global vehicle dynamics simulation of passenger cars, racecars up to lightweight trucks, articulated lorries and buses. CarMaker can perform simulations either as stand-alone application or as embedded environment in Simulink. In this thesis, considering that it's more convenient to add own control functions, and make changes, CarMaker with Simulink model is used to build all functions and blocks inside.

In simulation, one can use the variables from the model as input to the controller. This is not possible in a real vehicle, where some signals are not available from sensors. Hence, a vehicle state estimator is built to estimate vehicle states. It is in a close loop with PISC function, and can be regarded as a part of function itself. There is more discussion in *Chapter 2.3 - Vehicle State Estimator*.

### 2.1 General description

A virtual vehicle is a computer-modeled representation of an actual vehicle with a behavior that emulates that of its real world counterpart. With CarMaker, the virtual vehicle is made up of mathematical models that contain the equations of motion, kinematics, etc. along with other mathematical formulas that define the multibody system (IPG, 2013, *User's Guide*). The virtual vehicle contains models of all parts of a real vehicle, including powertrain, tyres, chassis, brakes, etc. The vehicle body is the central model. It consists of the multibody vehicle model along with predefined interfaces to other modules. The vehicle body module interferes with other modules from the vehicle library.

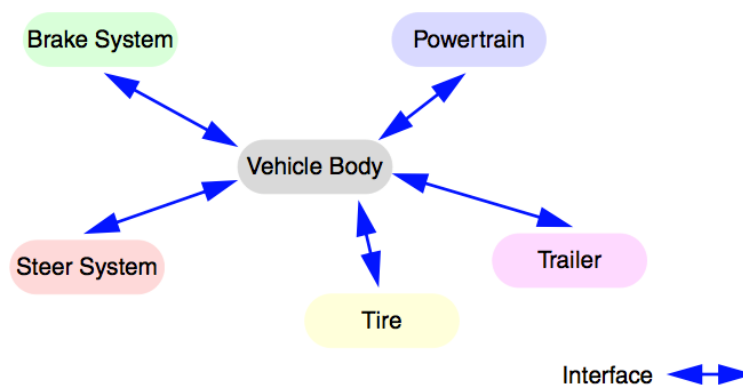

Figure 2.1 Modules interfering with the vehicle body (IPG, 2013, *Reference Manual*)

The motion of the multi body system is described with differential and with algebraic equations. Figure 2.2 represents the multibody system which consists of five rigid bodies interconnected by five joints. The rigid bodies may move in space and relative

to each body. The chassis body (Fr1) is connected to the ground body (Fr0) with a 6 degree of freedom joint. The wheel carrier bodies (Fr2ij) are connected with the chassis body with a complex 1 degree of freedom joint. Between the front (rear) left and front (rear) right wheel carrier a kinematical dependence (coupler) can be modeled, e.g. a rigid axle. The wheel carrier center follows a trajectory through 3D space, relative to the chassis, as function of the suspension compressions and the steering rack position.

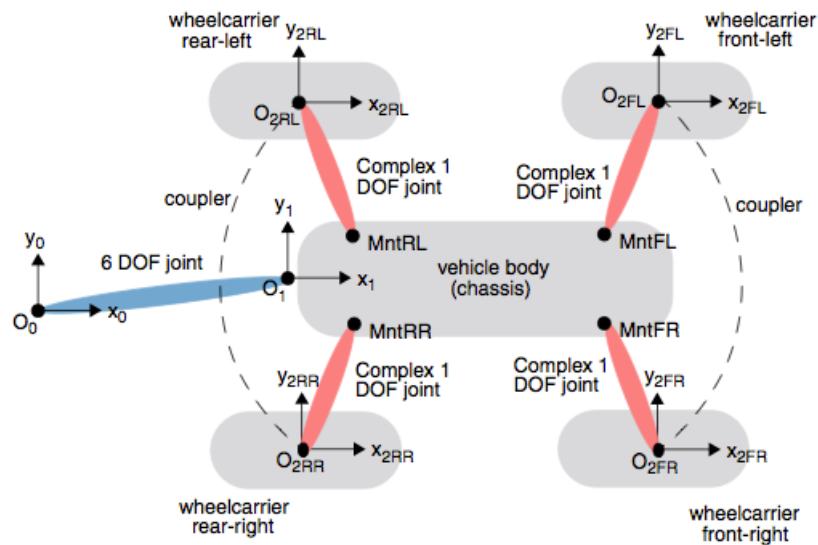

Figure 2.2 Joints within the vehicle module (IPG, 2013, Reference Manual)

Steering systems are distinguished by the type of input (control) signals used – steer by angle or steer by torque. The steering rack influences the kinematic constraints. Magic Formula tyre model is used, with considering effective tyre rolling radius and combined slip computation. The contribution of each suspension force element results in the wheel contact force. Four types of force elements are modeled: the suspension spring, the suspension damper, the suspension buffer and the stabilizer or anti-roll bar or stabilizer bar. The brake system acts like a conventional one circuit brake. A master brake pressure is built proportional to the input value of the brake pedal. The braking torque for each individual wheel is calculated by a conversion factor.

CarMaker can perform simulations as embedded environment in Simulink. The model was implemented in Simulink with 5 main blocks. In each block, several levels of sub-blocks are built. Thus it is easy to integrate software-modeled controllers into the virtual vehicle by using software in the loop. The most top level of the vehicle model can be seen in Figure 2.3.

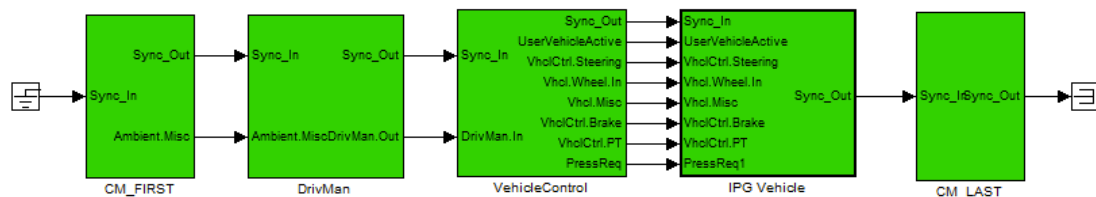

Figure 2.3 Top level of the vehicle model



The vehicle used in the thesis is a medium-size passenger vehicle, front-drive with transverse engine orientation. Maximum engine torque is 124Nm at 3500rpm. It has a five-speed manual gearbox. McPherson Suspension is used for front axle, while rear axle uses Linear 2-DOF suspension. Steering system is Rack-pinion with power assist module. The input of steering system can be steering angle or steering torque.

### 2.1.1 Steering actuation

PISC function is located in VehicleControl block from Figure 2.3. Steering actuator is modeled as ideal. For instance, requested steering angle from PISC function is fed directly to the model's steering angle, see Figure 2.4.

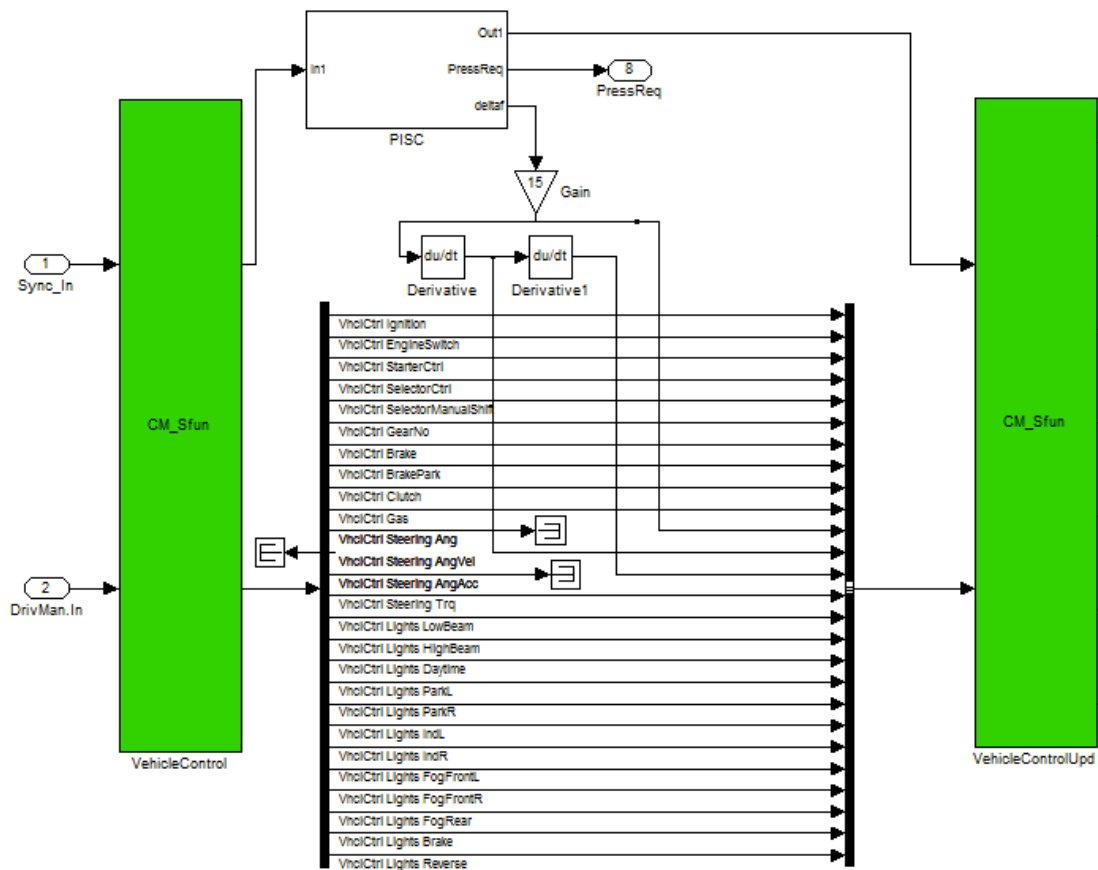

Figure 2.4 PISC function is embedded in the model (Part of block "Vehicle Control" from Figure 2.3).

The Sync\_In and Sync\_Out ports are an important concept in CarMaker for Simulink. They guarantee proper order of execution of the CarMaker blocks. CM\_Sfun is packaging Matlab S-Function developed by CarMaker, and it's not allowed for users to change the process inside.

Another way to control the steering is via Electric Power Assisted Steering (EPAS) block. Compared with former steering actuation, it's not a direct way to control the

steering angle, since steering torque is exerted on the vehicle instead of feeding steering angle to the model directly.

The input of EPAS block is desired and actual steering angle, and the output is steering torque. Steering torque is calculated based on PD control of steering angle. The equations are shown below.

$$\begin{cases} diffSA = Desired\_SteerAngle - Actual\_SteerAngle \\ Steering\ torque = 130 \cdot \left( diffSA + \frac{d}{dt} diffSA \right) \end{cases} \quad (2.1)$$

The rate of steer torque is limited with -100 N/s and 100 N/s, and saturated at 5Nm. See Figure 2.5.

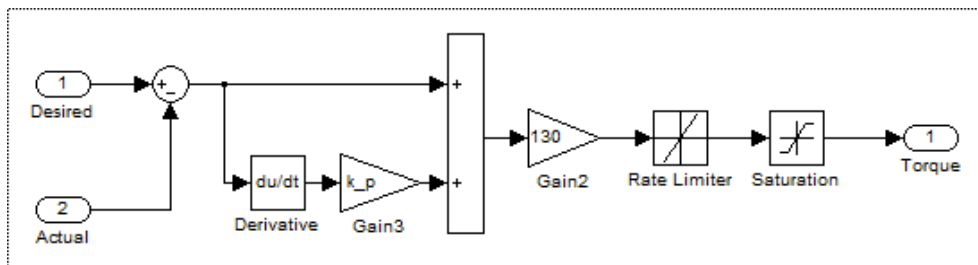

Figure 2.5 EPAS block in Simulink.

### 2.1.2 Brake actuation

The original CM\_Sfun of Brake in CarMaker is totally replaced by User-defined braking system. It calculates all the required brake signals. See Figure 2.6.

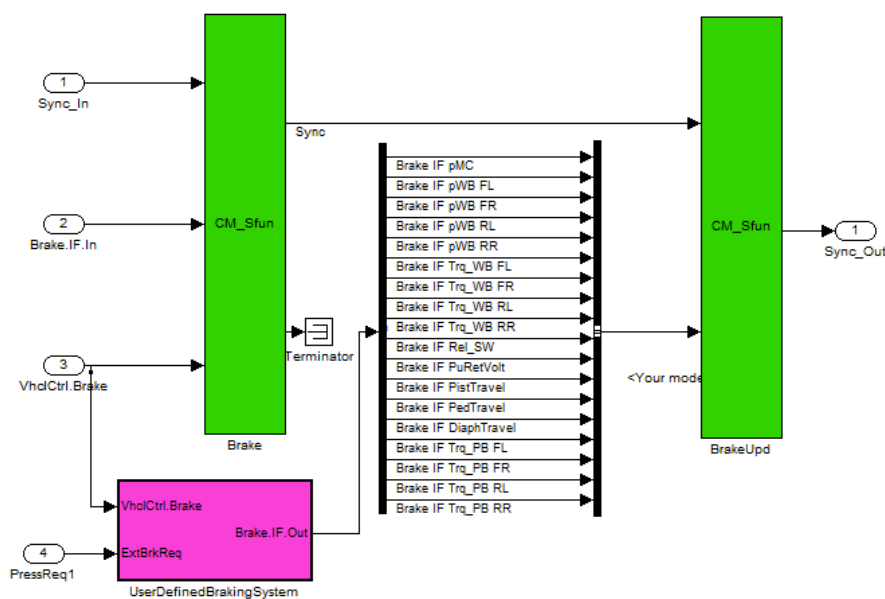

Figure 2.6 Replace Brake CM\_Sfun by User-defined Braking System.

In the User-defined braking system, input of the block - brake pressure (PressReq) is calculated by PISC, ESC or ABS functions. Brake torque for individual wheels are calculated from brake pressure, by multiplying 12.9 and 5.5 for front and rear wheels respectively. The numbers is calculated according to the brake system of chosen vehicle, and the fact that 70% brake torque is exerted on front wheels, and 30% on rear wheels. Other signals including driver brake and park brake torque are set to 0.

## 2.2 Description of relevant functions

Models of several functions are used in the thesis: PISC function, ESC function, ABS function and Post Impact Braking (PIB) function. Their principles and behaviors are quite different. PISC and PIB are used to control vehicle after initial impact; ESC is to keep vehicle stable - neither oversteer nor understeer; ABS is used to prevent wheels from locking up, in order to maintain tyre braking force and enable margin tyre for lateral force.

Electronic Power Assist Steering (EPAS) is discussed here. Instead of directly feed steering angle to the vehicle model as an idea steer-by-wire instrument, it outputs steering torque to make effects on steering angle like the way that real vehicle does. Actual steering angle is controlled to be close to the expected value as much as possible.

### 2.2.1 PISC function

The PISC function was developed during the PhD thesis of Derong Yang (Yang D. 2013). It is aimed at minimizing the global lateral displacement of vehicle by controlling steering angle and brake torque, thus limits the vehicle lateral movement from the original path. The structure in Simulink is shown in Appendix A.

Some vehicle states are taken as inputs to this function, including longitudinal velocity, lateral velocity, yaw angle, yaw rate, vertical force for each wheel, signs of individual wheel rotation, global lateral displacement. At the same time, it outputs steering angle for front axle and brake force for each wheel to make the vehicle go back to original path after severe impact. Rate limiters and saturations are added after the outputs, in order to model the response delay of actuators.

PISC function is a quasi-linear optimal controller (QLOC), which uses nonlinear optimal control theory to provide a semi-explicit approximation for optimal post impact path control (Yang D., Gordon T. J., Jacobson B., Jonasson M. 2012). It's realized by combining linear costate dynamics with nonlinear constraints due to tyre friction limits.

An important concept in PISC function is  $\lambda$ , which represents the trade-off between two global forces that are critical in reducing the cost, i.e. maximum lateral deviation. These two global forces are the vehicle yaw moment ( $M_z$ ) and vehicle lateral force perpendicular to the desired road path ( $F_{yg}$ ).

PISC function is triggered at the time that impact finishes, and stops working when maximum global lateral displacement is achieved. This is implemented as  $\dot{Y}$  becomes 0.

### 2.2.2 ESC function

ESC is to apply the brakes to help turn the vehicle where the driver intends, especially keep vehicle stable – neither oversteer nor understeer. In order to measure how much the vehicle turns, yaw rate is chosen as the key parameter. For the control strategy, actual yaw rate is compared with a reference value. The reference value represents the yaw rate that the driver intends and is calculated from steering (wheel) angle. The structure in Simulink is shown in Appendix B.

The reference value of yaw rate is calculated based on a bicycle model with 3 degree of freedom. It takes longitudinal speed, lateral speed and steering angle as inputs, and outputs reference yaw rate to calculate brake pressure for each wheel. A bicycle model is used here. First, the slip angle of front and rear wheel are calculated,

$$\begin{cases} \alpha_1 = \delta - \operatorname{atan}\left(\frac{v_y + l_f \cdot r}{v_x}\right) \\ \alpha_2 = -\operatorname{atan}\left(\frac{v_y - l_r \cdot r}{v_x}\right) \end{cases} \quad (2.2)$$

Then lateral forces for front and rear axles  $F_{yf}$  and  $F_{yr}$  are calculated, where  $F_{yf}$  is limited by the maximum friction force on the road.

$$\begin{cases} F_{yf} = \min(\alpha_1 \cdot C_{a,f}, \mu \cdot F_{zf}) \\ F_{yr} = \alpha_2 \cdot C_{a,r} \end{cases} \quad (2.3)$$

So the derivative of lateral velocity  $v_y$  and yaw rate  $r$  can be calculated,

$$\begin{cases} \dot{v}_y = \frac{F_{yf} + F_{yr}}{m} - r \cdot v_x \\ \dot{r} = \frac{F_{yf} \cdot l_f - F_{yr} \cdot l_r}{I_{zz}} \end{cases} \quad (2.4)$$

Through these equations, the states  $v_y$  and  $r$  can be updated over time through integration.

Then, real yaw rate is compared with reference value. The more deviation, the more brake ESC exerts on individual wheels to assist steering in order to correct yaw rate error.

$$r_{err} = r_{actual} - r_{ref} \quad (2.5)$$

$$\text{Brake Pressure} = 500 \cdot r_{err} \quad (2.6)$$

The demanded brake pressure is calculated according to the deviation. The rate between brake pressure on wheels and yaw rate deviation is set as 500 bar/(rad/s) for both front and rear wheels. For each time to brake, either left-side wheels or right-side wheels will brake together to force actual yaw rate to get close to the yaw rate reference. The basic principle is, when oversteer happens, outer wheels are braked to make the vehicle yaw outwards, and when understeer happens, inner wheels are braked to make the vehicle yaw inwards. Detailed control strategy is shown in Table 2.1.

*Table 2.1 Control strategy of ESC function*

Conditions		Actions (Braked wheels)	Description
Actual yaw rate	Yaw rate error		
> 0.03 rad/s	> 0.03 rad/s	Front-right and Rear-right	Oversteer
	< -0.03 rad/s	Front-left and Rear-left	Understeer
< -0.03 rad/s	> 0.03 rad/s	Front-right and Rear-right	Understeer
	< -0.03 rad/s	Front-left and Rear-left	Oversteer

Here ESC is expected to be not so sensitive, and control the vehicle only when it's out of stable range. So when actual yaw rate and yaw rate error is low, ESC is not expected to work.

The ABS function will further limit how much brake pressure is applied to the wheel. There are longitudinal wheel slip limits that triggers ABS. ESC can change these limits in different conditions, especially on the braked wheels.

The limit value will be changed depending on oversteer or understeer. When oversteer happens, the outside-braked front wheel tend to slip more, thus the desired value is decreased to -0.6, and for the outside-braked rear wheel -0.07. The non-brake wheels still keep -0.2 desired slip. For understeer condition, the inside-braked front wheel is -0.07 desired slip instead, the braked rear wheel is -0.6, and non-brake wheels are -0.2.

The sine with dwell maneuver is used by the NHTSA (National Highway Traffic Safety Administration) of the USA to evaluate ESC performance. Herein, a similar sin with dwell is also used to evaluate ESC's performance. This steering angle is showed in Figure 2.7. The vehicle speed is set to 80km/h.

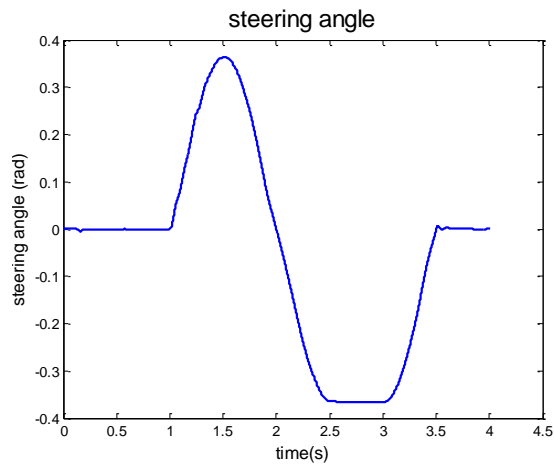

Figure 2.7 steering angle

The test results are showed in Figure 2.8 – 2.12:

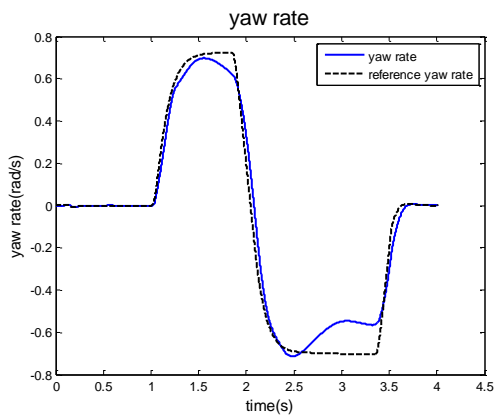

Figure 2.8 yaw rate when ESC off

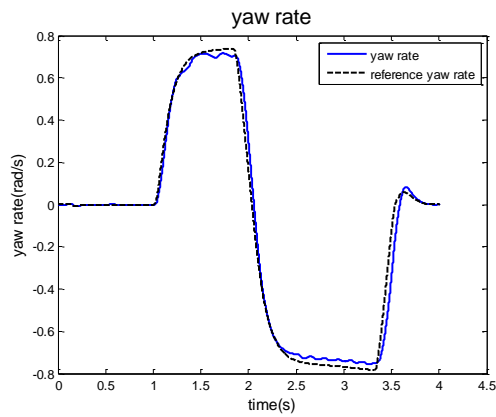

Figure 2.9 yaw rate when ESC on

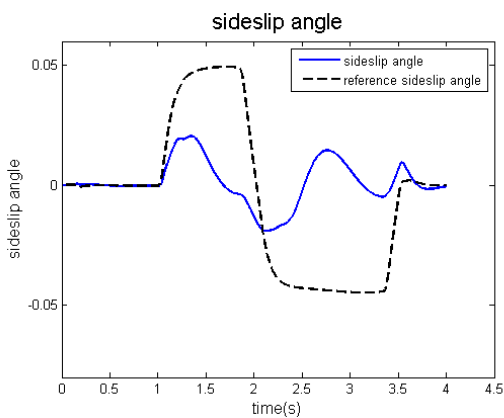

Figure 2.10 lateral velocity when ESC off

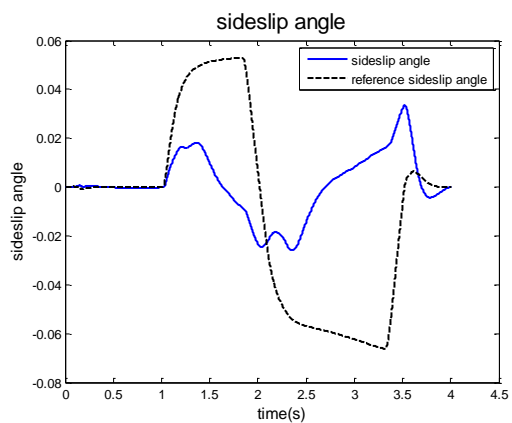

Figure 2.11 lateral velocity when ESC on

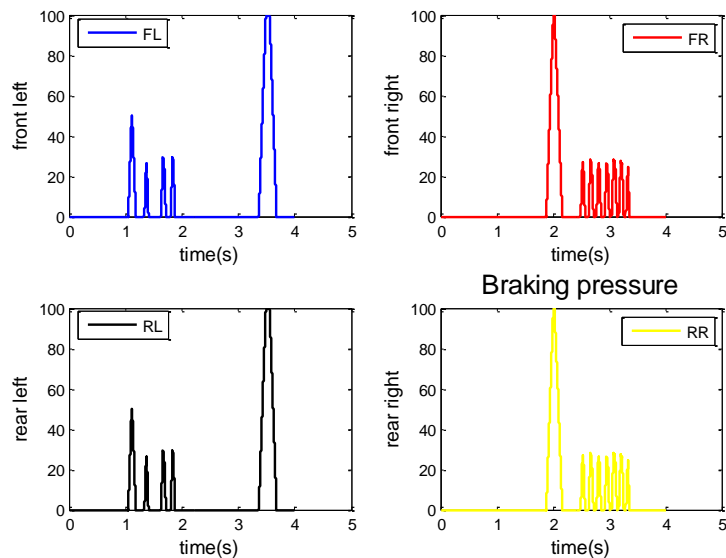

Figure 2.12 Brake pressure when ESC on

In Figure 2.8-2.11, the black line is the reference value calculated by reference model in ESC function with the steering angle as the input, the blue line is the actual value. It can be seen the actual yaw rate is more close to the reference yaw rate when ESC is on, therefore, this ESC function works very well. But the lateral velocity doesn't become better when ESC on, that is because this ESC is designed only for yaw rate error. From Figure 2.12, it can be seen that from 1s to 1.9s, the vehicle is turning to left and it is under-steer, so front left and rear left wheel brake. From 2s to 3.5s, the vehicle is turning to right and it is under-steer, so the front right and rear right wheel brake.

### 2.2.3 ABS function

ABS modifies demanded brake torque, practically reducing the pressure in the hydraulic brake calipers, in order to limit the longitudinal slip, preventing the wheels from locking up and avoiding uncontrolled skidding, thus maintain tractive contact with the road surface.

ABS is only enabled when vehicle speed above 4 m/s and brake is demanded. If so, longitudinal slip of each wheel will be compared with its desired value. If the real value is lower than the desired, or decreases quickly, that means vehicle may lose effective traction force on the road and tends to skid. Then the demanded brake pressure will be reduced to get traction force recovered, thus longitudinal slip could go back to a safe range.

How much brake pressure is reduced depends on the PID control of difference between desired and actual longitudinal wheel slip. The coefficients of each part,  $K_i$ ,  $K_p$ ,  $K_d$ , are 2,10,1. The equations are shown below.

$$\begin{cases} Diff = SlipLimit - Actual\ slip \\ Brake\ pressure\ reduction(\%) = Ki \cdot \int sign(Diff) \cdot dt + Kp \cdot deadzone(Diff) + Kd \cdot \frac{d(Diff)}{dt} \end{cases} \quad (2.7)$$

In integration part, only sign of difference is integrated. For proportion part, deadzone is used to provide region of zero output within -10000 and 0.2.

Generally, the desired longitudinal slip for each wheel is set as -0.2, but these 4 limits are input variable to ABS, so e.g. ESC can modify these 4 slip limits dynamically. See Chapter 2.2.2 ESC function.

The ABS function is evaluated by comparison of ABS on and ABS off when the vehicle is driving straight ahead in 70km/h and take the full brake (100 bar brake pressure).

The longitudinal slip and brake pressure with ABS on and off are recorded and shows in Figure 2.13 and 2.14:

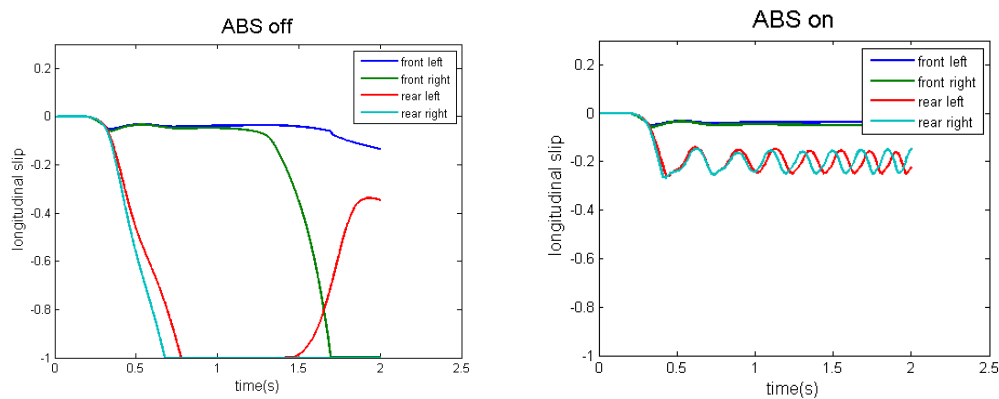

Figure 2.13 Longitudinal Slip

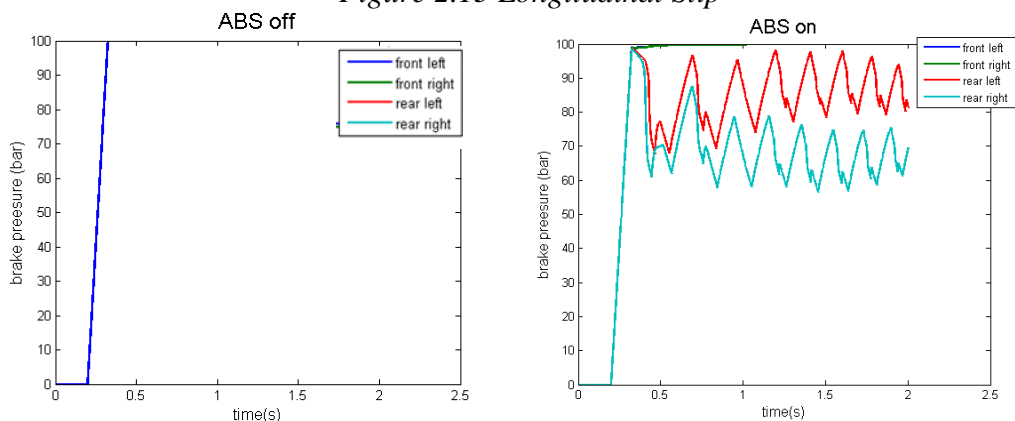

Figure 2.14 Brake Pressure

From above Figures, when ABS is on, only rear wheels' longitudinal slip is beyond -0.2. Therefore, ABS only controls two rear wheels' brake to limit them to -0.2. One of the generic ABS is used to verify our ABS, the performance of it is showed in Figure 2.15 and 2.16:



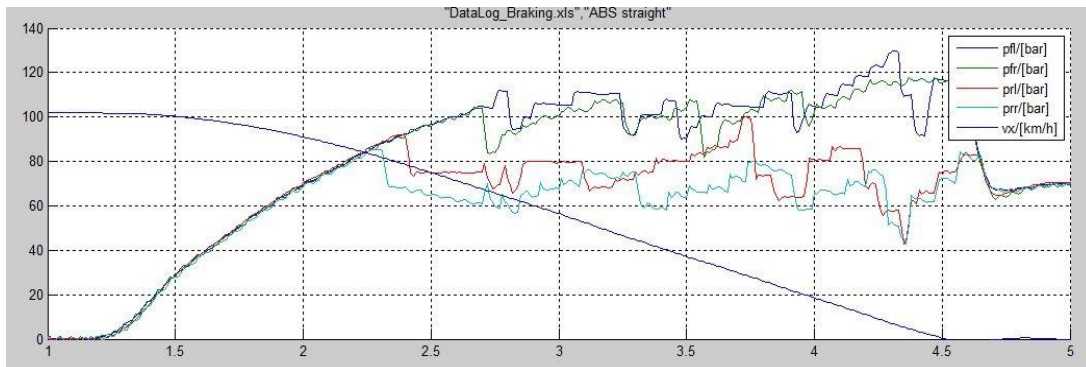

Figure 2.15 Braking Pressure

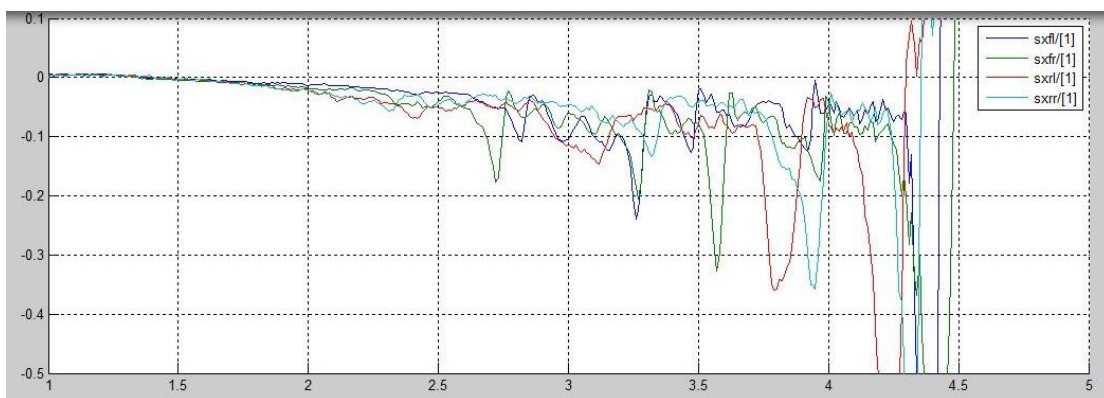

Figure 2.16 Longitudinal Slip

It can be seen from above, our ABS performs similar as generic ABS.

## 2.2.4 PIB function

PIB function brakes vehicle as much as possible after impact. For each wheel, 90% of available friction force on the road is hopefully used as brake force (in order to avoid tyre slip). The ABS function will further limit how much brake pressure is applied to the wheel based on longitudinal slip. See Figure 2.17.

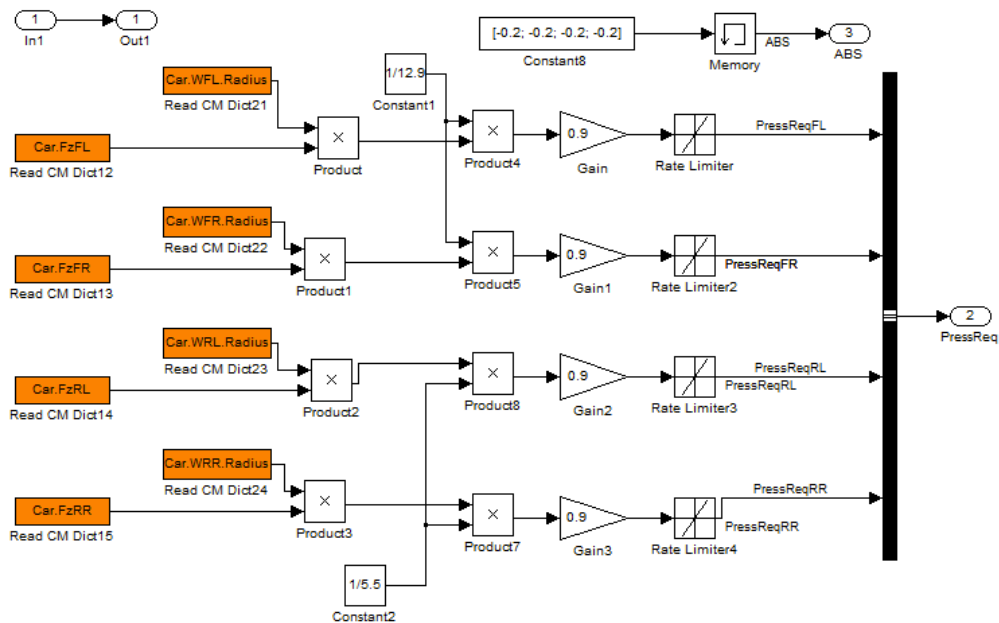

Figure 2.17 PIB function in Simulink.

## 2.3 Vehicle State Estimator

An estimator is built to work as a simplified vehicle model that is closed loop with PISC function - PISC receives estimated vehicle states, and gives out control signals to estimator.

The estimator consists of three main blocks – tyre side slip angle calculations, tyre model, and vehicle model. Slip angle of tyres is calculated by vehicle states and steering angle coming from PISC function, and then tyre model outputs longitudinal force and lateral force for each wheel, in order to calculate vehicle states in vehicle model block. Magic tyre formula is used in tyre model, and forces are limited by maximum. Vehicle model has 3 degree of freedom – longitudinal, lateral, and yaw. The derivatives of each are calculated from forces, and then integrated. See Figure 2.18.

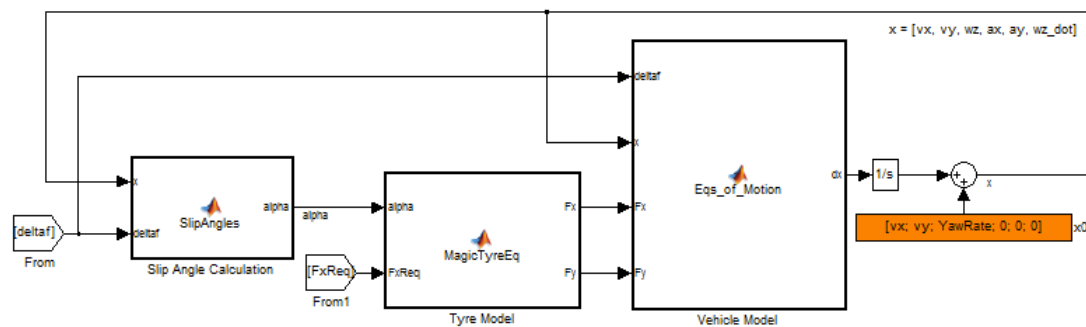

Figure 2.18 Vehicle State Estimator in Simulink.

In example of front-left wheel, tyre slip angle is calculated as,

$$\alpha = \delta - \arctan\left(\frac{v_x - w \cdot r}{v_y + l_f \cdot r}\right) \quad (2.8)$$

Magic tyre is given by

$$F_y = F_{y\_max} \cdot \sin(C \cdot \arctan(B \cdot \alpha - E \cdot (B \cdot \alpha - \arctan(B \cdot \alpha)))) \quad (2.9)$$

Vehicle states is calculated by the following equations,

$$\begin{cases} \dot{v}_x = \frac{\Sigma F_x}{m} + v_y \cdot r \\ \dot{v}_y = \frac{\Sigma F_y}{m} - v_x \cdot r \\ \dot{r} = \frac{\Sigma M}{I_{zz}} \end{cases} \quad (2.10)$$

According to these calculations, the vehicle states like  $v_x$ ,  $v_y$  can be predicted via simulations.

## 2.4 Function Integration

Generally, impact process can be divided into three parts – before impact, during the impact, and after impact. The focus of thesis is how vehicle performs after impact under the control of functions. What type impact is and how impact happens is not taken into consideration. Thus in simulations, vehicle is always set to start at an unstable condition, trying to simulate the condition where vehicle is after impact.

PISC could perform well to control the vehicle after impact. The working range is verified in the thesis for the specified vehicle. Besides, how PISC works together with ESC is also a topic that attracts attention. PISC will be tested with vehicle states from vehicle model or estimated vehicle states, while ABS is added in all models.

To clarify the models discussed here, the short names are listed in Table 2.2.

*Table 2.2 Short name of Models*

<b>Name</b>	<b>Description</b>
PISC CM	only PISC using true vehicle states
PISC+ESC CM	PISC and ESC function using true vehicle states
PISC Est	only PISC using estimated vehicle states
PISC+ESC Est	PISC and ESC function using estimated vehicle states

The driver is modeled as neither steering nor braking with brake pedal. Steering angle is kept at zero when PISC is off.

The sketches of PISC, ESC and ABS function is shown in Figure 2.19. The inputs and outputs are clarified.

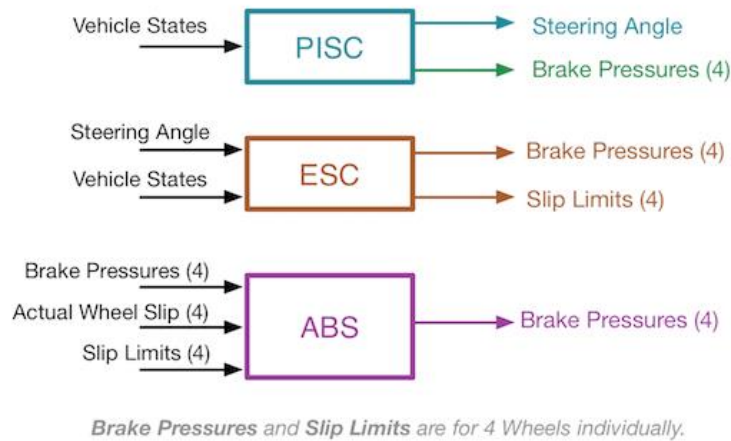

Figure 2.19 Sketches of PISC, ESC and ABS function.

### 2.4.1 PISC with vehicle states from model

The simplest model includes PISC and ABS functions. PISC receive signals from CarMaker, regarded as a controlled vehicle in Figure 2.20, CarMaker simulates the whole vehicle performance, and is regarded as a real vehicle.

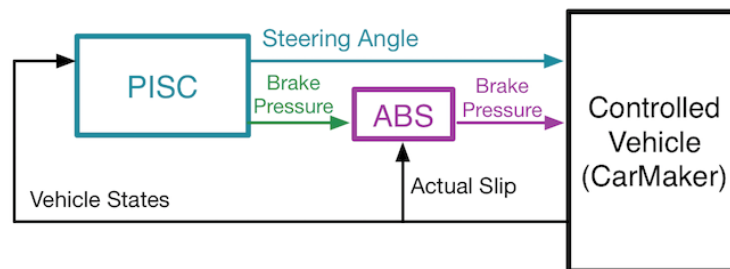

Figure 2.20 PISC CM

In this model, PISC receives speed and yaw rate etc. from CarMaker, and output steering angle to it. Brake force for each wheel goes through ABS and may be reduced if high longitudinal slip happens on tyres, and final brakes are given to CarMaker.

Based on Figure 2.20, ESC function is added in the model in Figure 2.21, here CarMaker receives brake force from ESC instead of PISC.

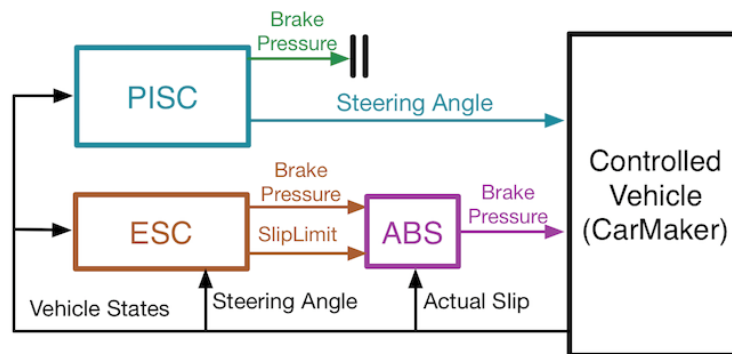

Figure 2.21 PISC+ESC CM

Performance of this kind of function combination is hard to predict, because PISC and ESC have different objectives. PISC is aimed at reducing maximum global lateral displacement while ESC is used to make vehicle neither understeer nor oversteer. The results may become better where ESC adds benefit on stabilizing vehicle, or worse because of conflict of functions. The comparisons of different scenarios are shown following.

## 2.4.2 PISC with estimated vehicle states

In real-time test, certain vehicle states can't be measured exactly. Hence we use a 3-DOF vehicle model as Vehicle State Estimator since PISC is lack of sensor information from the real vehicle. The Vehicle State Estimator calculates all the input signals that PISC function needs. Hence, PISC function receives estimated signals from Vehicle State Estimator, instead of ones from controlled vehicle.

ABS further limits the brake pressure with receiving actual longitudinal slip from the controlled vehicle, regarded as a real-time function. While the blocks within dashed box - PISC function and Vehicle State Estimator can operate in off-line environment, and gives pre-computed steering angle and brake pressures to the vehicle. ABS function is not applicable in off-line environment, because Vehicle State Estimator can't estimate longitudinal slip as a simplified vehicle model. See Figure 2.22.

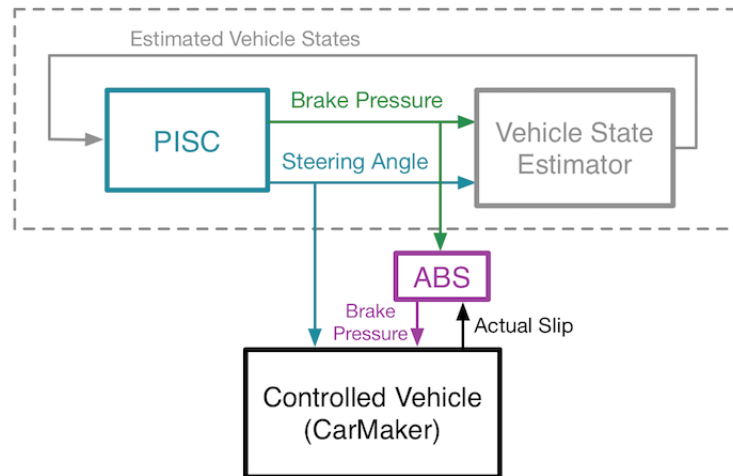

Figure 2.22 PISC Est

Similarly, ESC is added in this model. CarMaker receives steering angle from PISC in off-line simulation, and brake from ESC in on-line simulation with CarMaker, as shown in Figure 2.23.

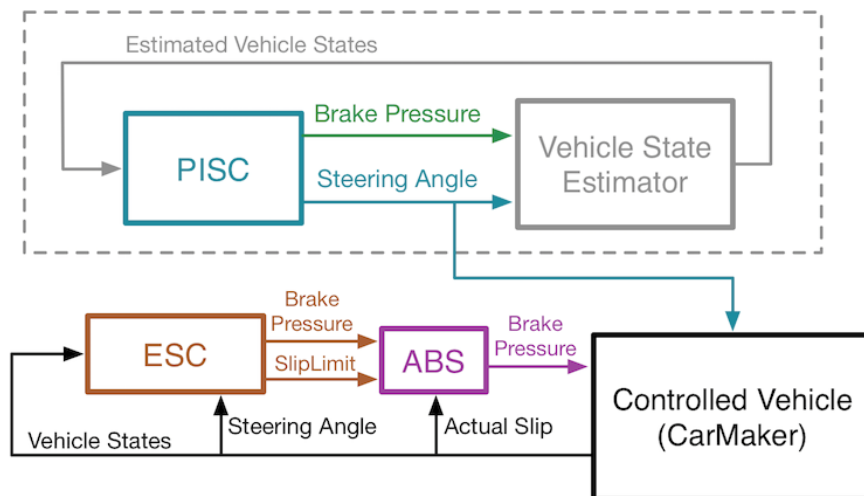

Figure 2.23 PISC+ESC Est

## 2.5 Post-impact initial condition set-up in CarMaker

From Paper (Yang D. 2013), Vehicle states longitudinal velocity, lateral velocity, yaw rate and yaw angle can be used to define the vehicle post-impact initial kinematics conditions. However, it is not guaranteed that other vehicle states e.g. pitch, roll etc. in a complex vehicle model, i.e. CarMaker model, are consistent with the pre-defined states. It remains future work to make a complete vehicle crash model, which can feed considerably more vehicle states for simulations after impacts.

However, as a verification test of the method stated above, a lateral force is applied to represent real impact force when the vehicle drives straight-forward. This simulation results can be seen as a reference to present real condition.

The initial condition before impact is showed in Table 2.3:

Table 2.3

Longitudinal Velocity (m/s)	Side slip angle (rad)	Yaw Velocity (rad/s)	Yaw angle (rad)
20	0	0	0

Then, a side force 40kN lasting 0.2s is used in the vehicle's front right wheel to simulate a side impact. The impact is located in vehicle coordinate [3 -0.762 0.605], represent the front right wheel. The simulation model is called PISC\_impact. After 0.2s, the vehicle states  $v_x$ ,  $v_y$ ,  $r$  and yaw angle are recorded, which is the post impact initial states, see Table 2.4:

Table 2.4

Longitudinal Velocity (m/s)	Side slip angle (rad)	Yaw Velocity (rad/s)	Yaw angle (rad)
19.87	0.086	1.73	0.2

Then another simulation model is directly changed to above states and this simulation model is called PISC\_initial.

Both simulation models have PISC function and is assumed that driver has zero steering torque input, time begins from first impact. The verification results are showed in Figure 2.24 – 2.30:

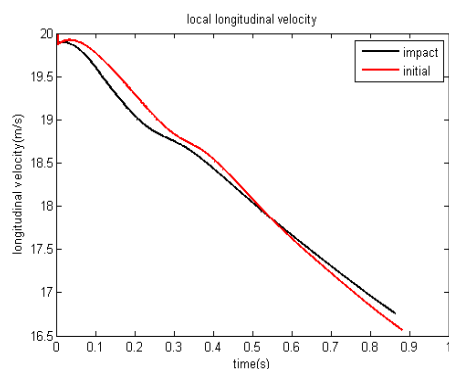

Figure 2.24 Longitudinal velocity

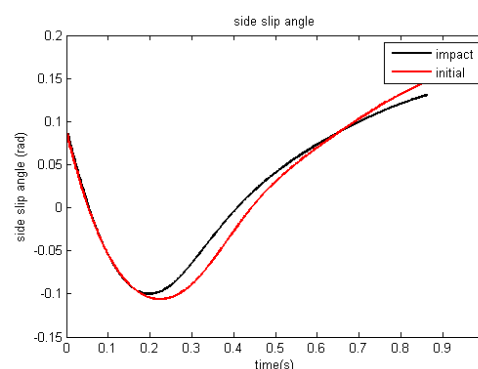

Figure 2.25 side slip angle

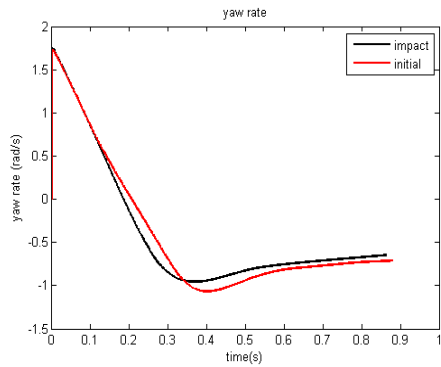

Figure 2.26 Yaw rate

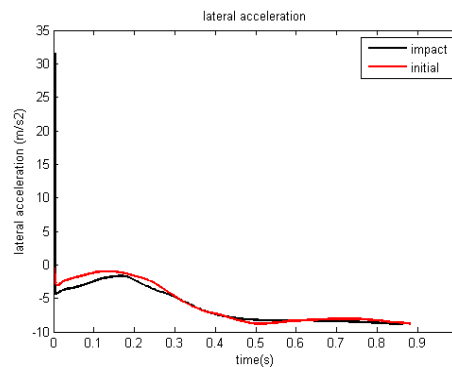

Figure 2.27 Lateral acceleration

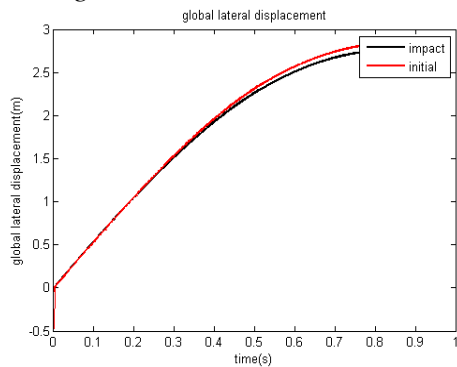

Figure 2.28 Global lateral displacement

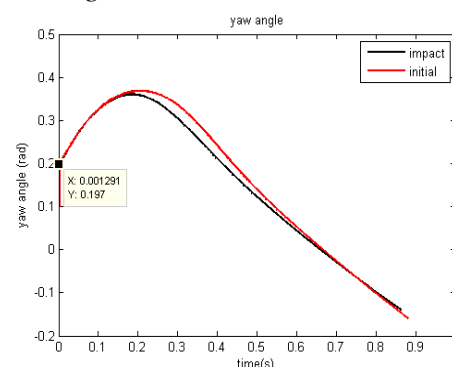

Figure 2.29 Yaw angle

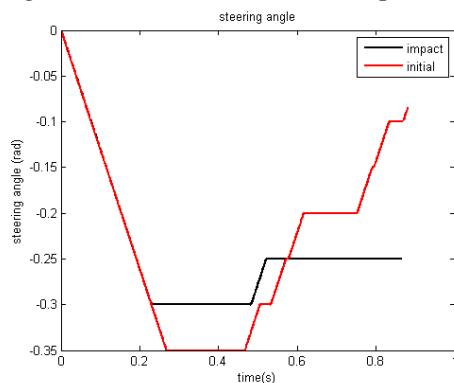

Figure 2.30 Steering Angle

The black line is the vehicle states in reference simulation PISC\_impact, the red line is the vehicle states in simulation by changing initial condition (only of  $v_x$ ,  $v_y$ ,  $r$  and  $\psi$ ) to post impact directly PISC\_initial.

It can be seen from above, the difference of them is very small and it doesn't influence the evaluation of PISC's performance. Therefore, directly changing vehicle states  $v_x$ ,  $v_y$ ,  $r$  and  $\psi$  in CarMaker (and keeping all other states initialized to zero) can well represent the real post impact condition for PISC evaluation.

In the simulation, we set initial conditions instead of applying forces at different part of car body that it's because it is easier and more systematic to post-impact vehicle dynamics simulation. It is also faster for online computation.



### 3 Function Performance

The test condition is  $v_x=15\text{m/s}$ ;  $v_y = 4\text{m/s}$ ;  $r$  is changed from  $-3\text{rad/s}$  to  $3\text{ rad/s}$  with  $0.2\text{ rad/s}$  interval;  $\psi$  is changed with  $r$  and assume it increases linearly with time, from zero, during the impact. So it has relationship with yaw rate  $r$ :

$$\psi = \left(\frac{r}{2}\right) * t_{\text{impact}}$$

We assume the vehicle is driven straight forward without any yaw rate before impact,  $r$  is the post impact yaw rate after impact,  $t=0.2\text{s}$  is the impact duration. Then we get different post impact  $\psi$  corresponding to different yaw rate.

By changing yaw rate from  $-3\text{rad/s}$  to  $3\text{ rad/s}$ , it can represent most of the post conditions by impact severity and locations. When yaw rate is negative, it represents the rear side impact; when yaw rate is positive, it represents the front side impact. And the bigger yaw rate is, the severer the impact is.

Since in first round simulation, the controller doesn't consider the symmetry problem, therefore it can only work for positive  $Y_{\text{max}}$ . In this first round simulation, when initial yaw rate is below than  $-2.4\text{ rad/s}$ , the  $\dot{Y}$  will be negative in the beginning of the post impact so that  $Y_{\text{max}}$  is negative. Therefore, in this round simulation, only consider yaw rate is bigger than  $-2.4\text{ rad/s}$ . The symmetric control algorithm for negative  $Y_{\text{max}}$  will be added in batch test in later chapter.

The criteria to evaluate PISC function is defined as below:

1. If Global lateral velocity  $\dot{Y}$  can reach 0. PISC works only if the  $\dot{Y}$  can reach 0 after impact. Because if  $\dot{Y}$  can't reach 0 and it is always positive, there is no  $Y_{\text{max}}$ .
2. Maximum global displacement  $Y_{\text{max}}$ . The smaller  $Y_{\text{max}}$  is, the better performance the function has. Because the aim of PISC function is to reduce global lateral displacement  $Y$ , it is reasonable to make  $Y_{\text{max}}$  as the main criteria.
3. The stability of the vehicle. It is also important for the performance of the PISC because it represents if the driver can control the vehicle rightly after PISC hands over control to the driver.

#### 3.1 Different configuration exploration

Firstly, 5 configurations (No control, PISC CM, PISC+ESC CM, PISC Est and PISC+ESC Est) are simulated and compared in this chapter. The comparison of them for  $Y_{\text{max}}$  is showed in Figure 3.1:

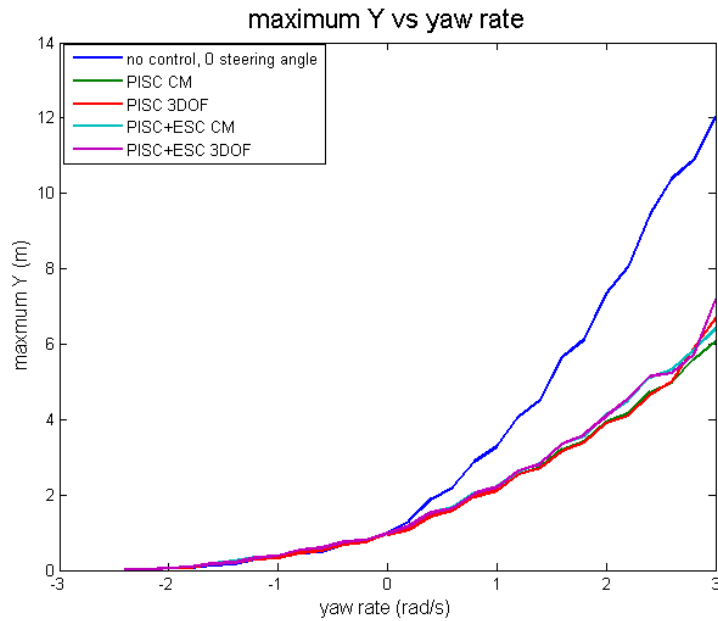

Figure 3.1  $Y_{max}$  comparison

From Figure 3.1, it can be found all 4 models with PISC function have smaller  $Y_{max}$  compared with No control. More specific comparison between these 4 models are presented below.

### 3.1.1 Comparison between PISC CM and PISC+ESC CM

The first comparison is between PISC CM and PISC+ESC CM and the aim of it is to find out how ESC influences PISC's performance.

After first comparison, both 2 models satisfy the first criteria, which means both can work in all conditions (from -2.4rad/s to 3 rad/s).

When yaw rate from -2.4 to -1.8 and 0.6 to 2.2, there is no big difference between both two models' performance (just PISC's  $Y_{max}$  is slightly better than PISC+ESC's), In Figure 3.2 and 3.3 shows one of the examples, which is the yaw rate = 1.6 rad/s:

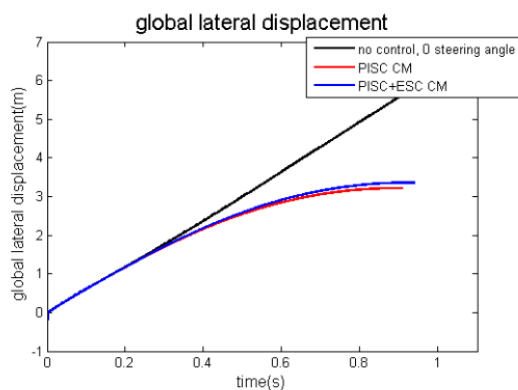

Figure 3.2 Global lateral displacement

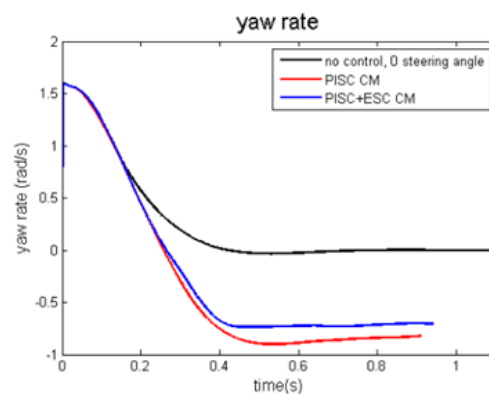

Figure 3.3 Yaw rate

When yaw rate is from -1.6 to 0.4, the  $Y_{max}$  of PISC CM is much better than PISC+ESC for percentage, but the difference value is actually still quite small. In Figure 3.4 shows one of the example, where the yaw rate = -0.6 rad/s:

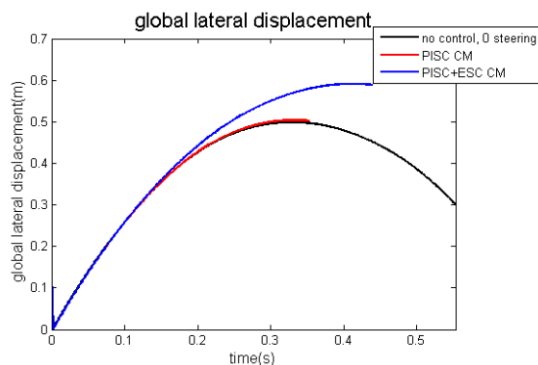

Figure 3.4 Global lateral displacement

When yaw rate from 2.4 to 3, the performance of PISC+ESC is better than PISC for stability. Although PISC's  $Y_{max}$  is slightly better than PISC+ESC's, stability of PISC+ESC is much better than PISC's since the magnitude of PISC+ESC's sideslip angle is lower than PISC's. In Figure 3.5 and 3.6 shows one of the example, which the yaw rate = 2.8 rad/s:

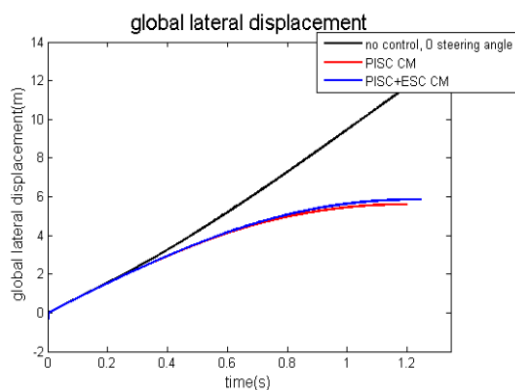

Figure 3.5 Global lateral displacement

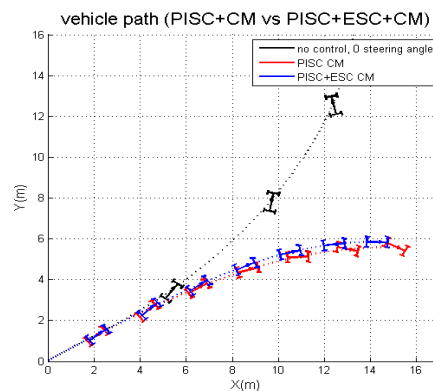

Figure 3.6 Vehicle Path

The reason for above differences is because the purpose of PISC is to reduce  $Y_{max}$ , but the purpose of ESC is to minimize the yaw rate error and stabilize the vehicle. Therefore, the brake torque given by these two functions is much different, then cause above differences. In Figure 3.7 shows one example of both models' brake torques:

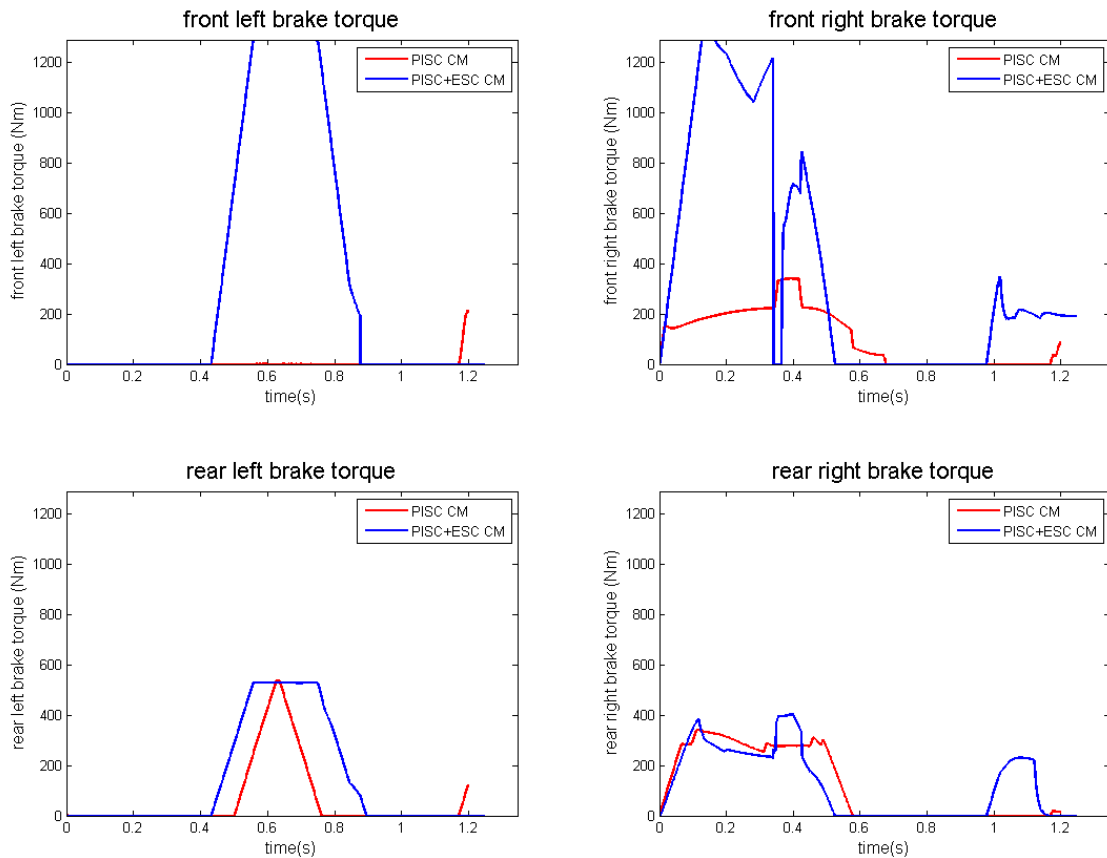

Figure 3.7 Brake Torque comparison

After above comparison, it can be seen that in all conditions, PISC CM is just slightly better than PISC+ESC CM for  $Y_{\max}$ . This difference is very small. But PISC+ESC's stability is much better than PISC's when the post impact yaw rate is very big, which is very beneficial for driver to control the vehicle after  $Y_{\max}$  is reached and thus PISC is switched off. Therefore, it can be concluded that overall PISC+ESC CM has satisfied performance as compared with PISC CM.

### 3.1.2 Comparison between PISC CM and PISC Est

The second comparison is between PISC CM and PISC Est and the aim of it is to find out how big PISC's performance will reduce if use estimator's input signals instead of real signals.

After comparison, it can be find out that when yaw rate is from -2.4 to 1.8, there is almost no difference between the performances of these two models, In Figure 3.8 and 3.9 shows one of the example, which the yaw rate = 1 rad/s:

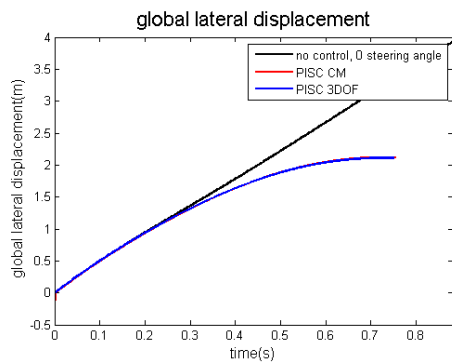

Figure 3.8 Global lateral displacement

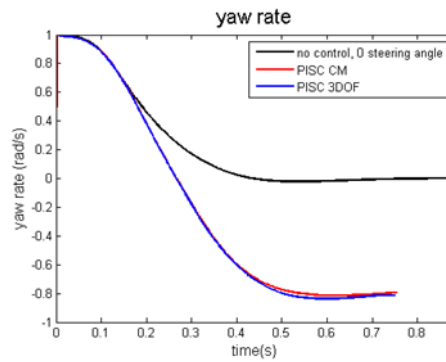

Figure 3.9 Yaw rate

When yaw rate is from 2 to 2.4, the steering angle of PISC Est begins to diverge to positive in the end so that the vehicle states begin to become different in the end, In Figure 3.10 and 3.11 shows one of the examples, which is the yaw rate = 2.4rad/s:

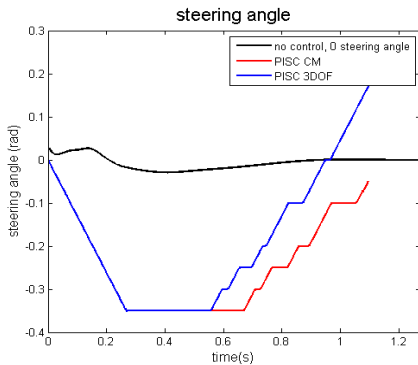

Figure 3.10 steering angle

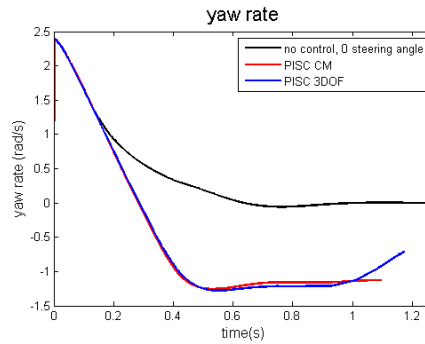

Figure 3.11 yaw rate

When yaw rate from 2.6 to 2.8, The PISC Est's global  $\dot{Y}$  can't reach 0, so it doesn't work. In Figure 3.12 shows one of the example, which yaw rate = 2.8 rad/s:

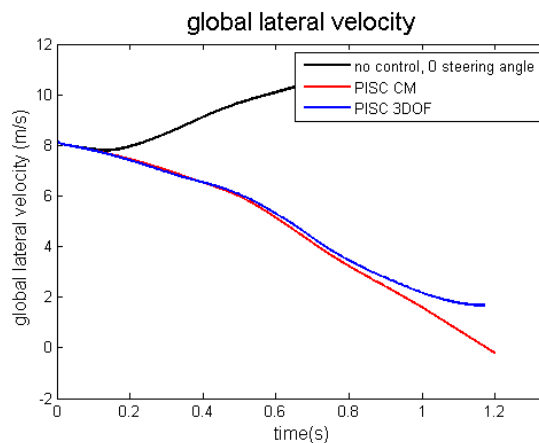

Figure 3.12 global lateral velocity

When yaw rate equal to 3 rad/s, the PISC Est begin to work again and there is only small difference between these two models. In Figure 3.13 and 3.14 shows the results when yaw rate = 3 rad/s:

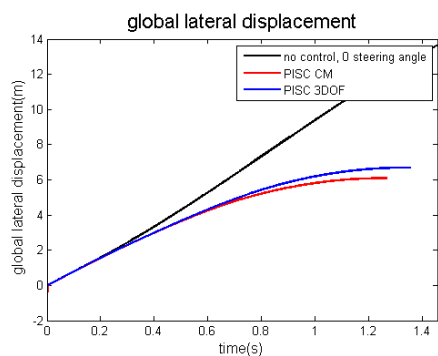

Figure 3.13 Global lateral displacement

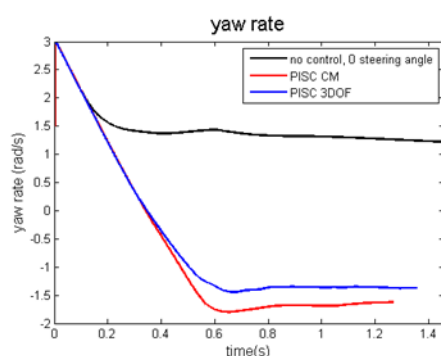

Figure 3.14 yaw rate

From above results, it can be find out that the PISC Est fails from yaw rate 2.6 to 2.8, but begin to work again in yaw rate 3 rad/s. The reason for it is shown in Figure 3.15 and 3.16:

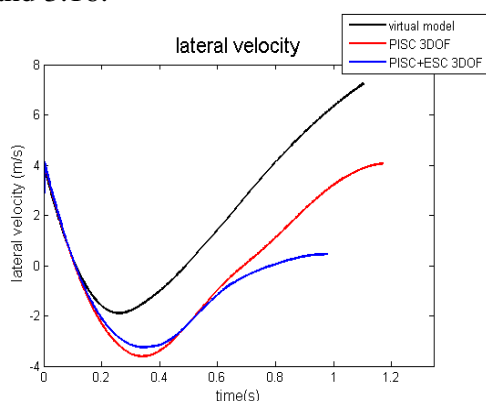

Figure 3.15 Lateral vehicle

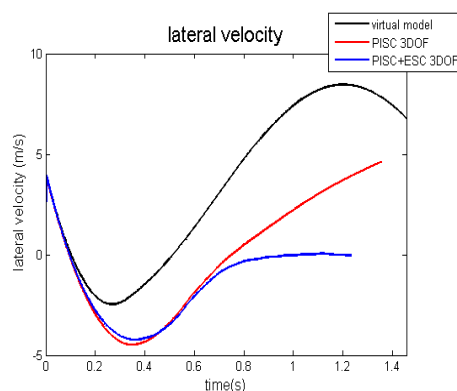

Figure 3.16 lateral velocity

The left Figure shows the comparison between vehicle lateral velocity calculated from estimator (black line) and the real lateral velocity of both models (red and blue lines) when initial yaw rate = 2.8 rad/s. The right Figure shows the same comparison but when initial yaw rate = 3 rad/s. It can be seen that whCen initial yaw rate increases to 3 rad/s, the lateral velocity calculated from estimator starts to turn down so that the difference between red line (PISC Est) and black line (estimator) becomes smaller. Therefore, the estimator can estimate relatively more correct vehicle states in yaw rate = 3 rad/s than 2.8 rad/s so that it can give more correct steering angle when yaw rate reaches 3 rad/s.

In summary, from above comparison, it can be concluded that estimator works very well in most of conditions, but in some sever conditions (the post impact yaw rate is big), it fails to work. Therefore, it still has the limitations.

### 3.1.3 Comparison between PISC Est and PISC+ESC Est

The third comparison is between PISC Est and PISC+ESC Est and the aim of it is to find out the difference between these both models.

When yaw rate from -2.4 to -1.8 and from 0 to 1.4, there is no big difference between these two models. But when yaw rate is bigger than 1.4 rad/s, with the yaw rate increases, the difference in the end of these two models becomes bigger. In Figure 3.17 and 3.18 shows the results when yaw rate = 1.6 rad/s:

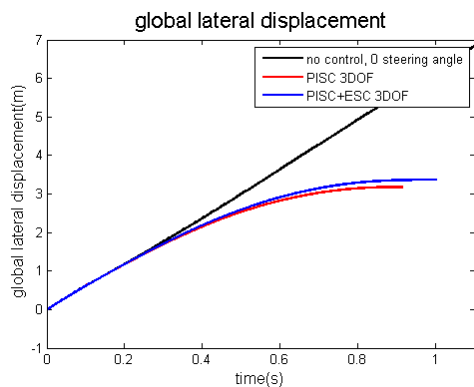

Figure 3.17 global lateral displacement

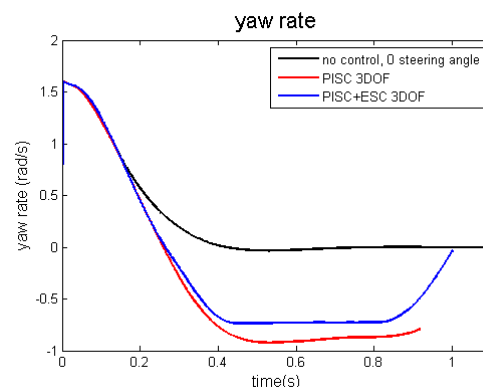

Figure 3.18 yaw rate

When yaw rate from -1.6 to -0.2, PISC Est has smaller  $Y_{\max}$  and is much better than PISC+ESC Est for percentage, but the difference of the value is still small. In Figure 3.19 shows the results when yaw rate = -0.8 rad/s:

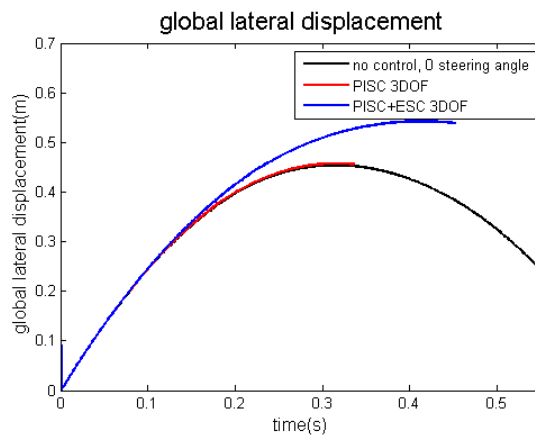

Figure 3.19 global lateral displacement

When yaw rate is from 2 to 3, PISC+ESC Est's global  $\dot{Y}$  can't reach 0, it doesn't work. (notice here PISC Est can't work only when yaw rate is from 2.6 to 2.8). In Figure 3.20 and 3.21 shows one of the examples, which yaw rate = 2.4 rad/s:

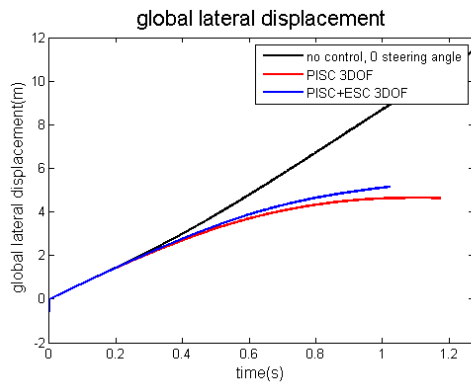

Figure 3.20 global lateral displacement

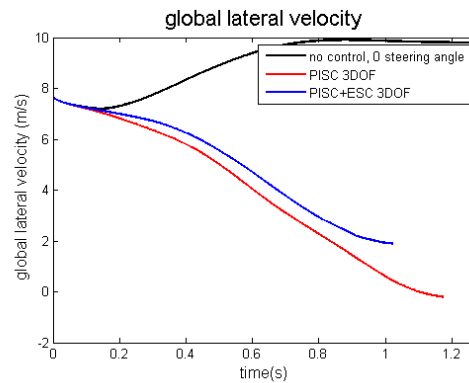

Figure 3.21 derivative of  $Y$

From above results, it can be seen that work range of PISC is limited when use the estimator instead of the real vehicle states, and it has much worse influence when PISC work together with ESC than when PISC works only. The reason for this is that the vehicle states ( $v_x$ ,  $\dot{Y}$ , etc.) calculated by estimator is very different as the real states, especially in failure cases, as showed in Figure 3.22 and 3.23 for example yaw rate = 2.4 rad/s:

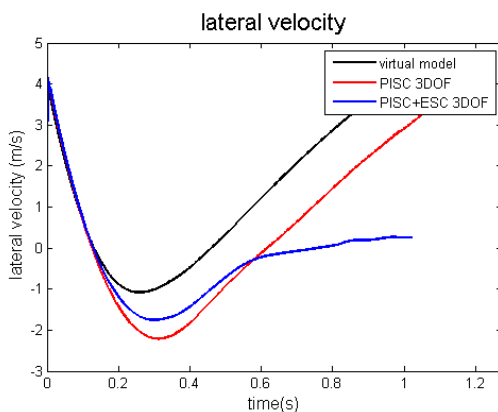

Figure 3.22 lateral velocity

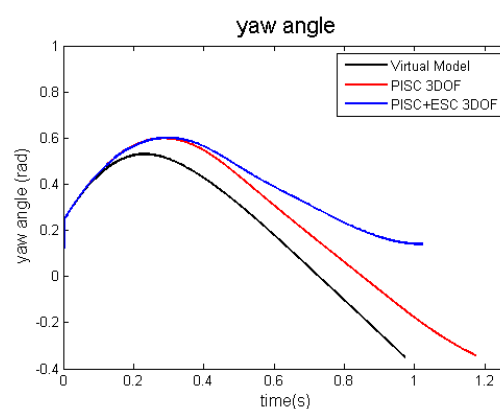

Figure 3.23 yaw rate

The black line is the vehicle states calculated by estimator, the red line is the real vehicle states of PISC Est and the blue line is the real vehicle states of PISC+ESC Est. It can be seen that the estimator's states has the same tendency as the real vehicle states of PISC Est, but is much different as PISC+ESC Est's, therefore, the PISC+ESC Est fails in this condition, but PISC Est still works.

From above evaluation, it can be concluded that the difference between estimator's vehicle states and real vehicle states leads to the failure of the PISC function. Therefore, the update of the real vehicle states to PISC function becomes very important in these failure cases.



### 3.2 Improve estimates of vehicle states

From section 3.1.3, it can be concluded that it is necessary to update vehicle states to PISC function's input and all input signals to PISC are  $v_x$ ,  $v_y$ ,  $r$ ,  $F_z$  and  $psi$ . It is not possible to update all signals because some signals' correct value still can't be got in real conditions. Therefore, it is needed to find out which signal is most important to PISC's performance. In section 3.2, each input signal is updated separately in both models (PISC Est and PISC+ESC Est) to test.

After the test, the summary of failure ranges of each updating test is showed in Figure 3.24. The green area represents working range and the red area represents fail range.

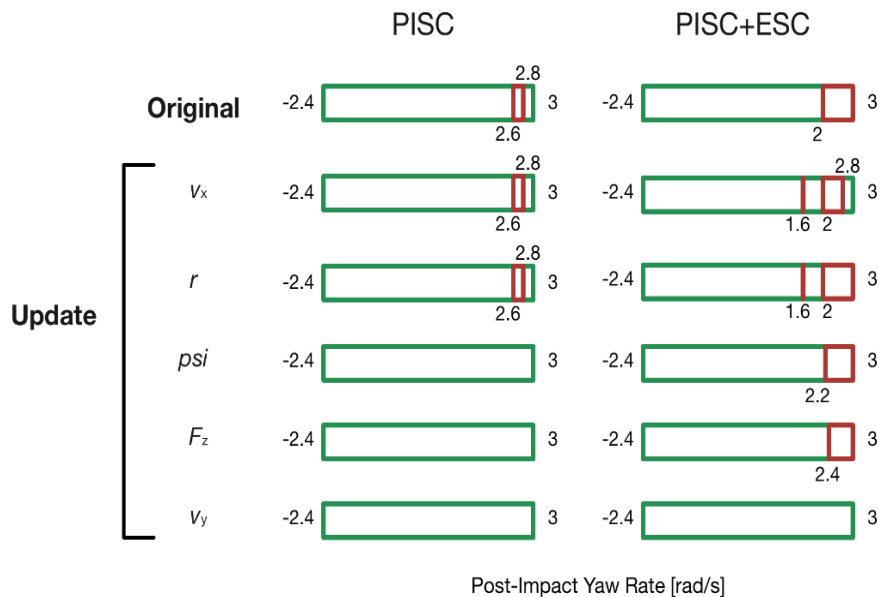

Figure 3.24 Working range of updating models

It can be seen from above results that it is not helpful when updating  $v_x$  and  $r$ , even it becomes worse for PISC+ESC Est. Updating  $psi$  or  $F_z$  have some improvement, but it still fails in some conditions for PISC+ESC Est. Updating  $v_y$  is most successful method and it works in all test conditions for both PISC Est and PISC+ESC Est. Therefore, it can be concluded that vehicle lateral velocity  $v_y$  is most important vehicle state for PISC function.

The reason why  $v_y$  is most critical input state for PISC function is showed in Figure 3.25 and 3.26:

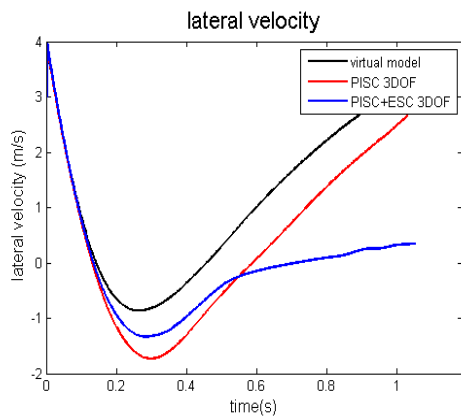

Figure 3.25 lateral velocity

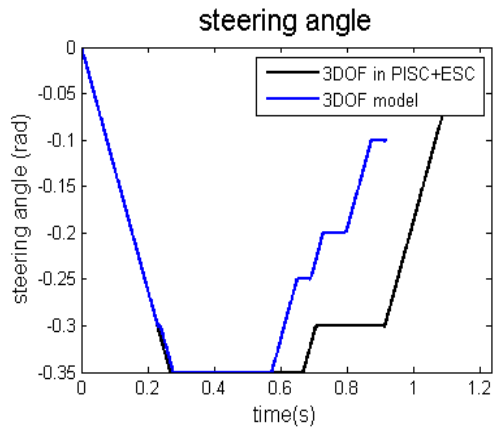

Figure 3.26 steering angle

The condition showed above is the yaw rate = 2.6rad/s. The left Figure is to show the reason why PISC Est works but PISC+ESC Est fails in this condition, both is without update real  $v_y$ . The red line and blue line are the real vehicle lateral velocity of PISC Est and PISC+ESC Est, respectively. The black line is the estimated lateral vehicle velocity calculated by estimator, which can be seen that its trend is closed to red line but very different as the blue line. Therefore, the difference of the lateral velocity between real and estimate leads to the fail of the function. The right Figure is to show how updating  $v_y$  influence the PISC's performance. The blue line is the steering angle from PISC without any updating and the black line is the steering angle when update  $v_y$  to PISC function. It can be seen that steering angle from PISC changes when update  $v_y$  and this difference makes PISC+ESC Est work.

### 3.2.1 Comparison between PISC Est and PISC+ESC Est (improve $v_y$ estimate)

When initial yaw rate is from -2.4 to 1.2, both models have almost same vehicle states, including steering angle. PISC Est is slightly better than PISC+ESC Est for  $Y_{max}$ . In Figure 3.27 shows one of the examples, when yaw rate = 0.8:

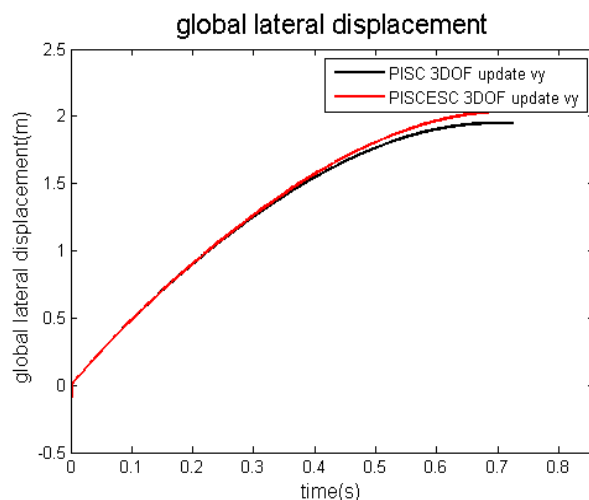

Figure 3.27 global lateral displacement

When initial yaw rate is from 1.4 to 3, for  $Y_{\max}$ , PISC Est is still slightly better than PISC+ESC Est. But with the initial yaw rate increases,  $v_y$  become different and it leads to the different steering angle from PISC functions. So vehicle with PISC+ESC Est is more stable than the vehicle with PISC Est in conditions with high initial yaw rate. In Figure 3.28 and 3.29 shows one example, when yaw rate = 2.6:

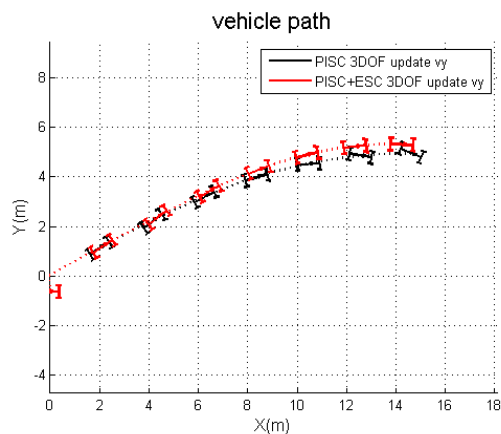

Figure 3.28 vehicle path

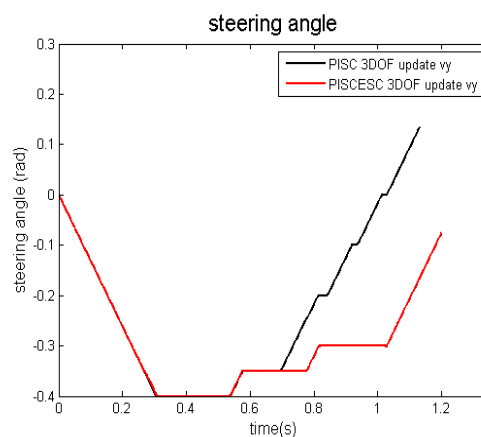

Figure 3.29 steering angle

### 3.3 Final model performance evaluation

From previous chapter, it can be seen that PISC+ESC Est with updating  $v_y$  is a feasible model with best performance. Therefore, this configuration is decided to be the final configuration.

#### 3.3.1 ESC K value influence

From chapter 2.2.2, ESC's basic equation is  $Brake\ Pressure = K \cdot r_{err}$ , this  $K$  is set to be 500 in all simulations, but it's value may have influence on PISC's performance, so it is important to explore the influence of  $K$  value for PISC. In section 3.3.1, its influence will be explored.

After simulation, it can be concluded that when yaw rate is from -2.4 to -1 and from 0.8 to 2.2,  $K$  value has not significant influence to the performance of the PISC function at all.

When yaw rate is from -0.8 to 0.6, the smaller  $K$  is slightly better than bigger  $K$  for  $Y_{\max}$ . But when  $K$  is bigger than 500, the influence of  $K$  value will become very small. Here shows one of the example, when yaw rate = 0.2 rad/s:

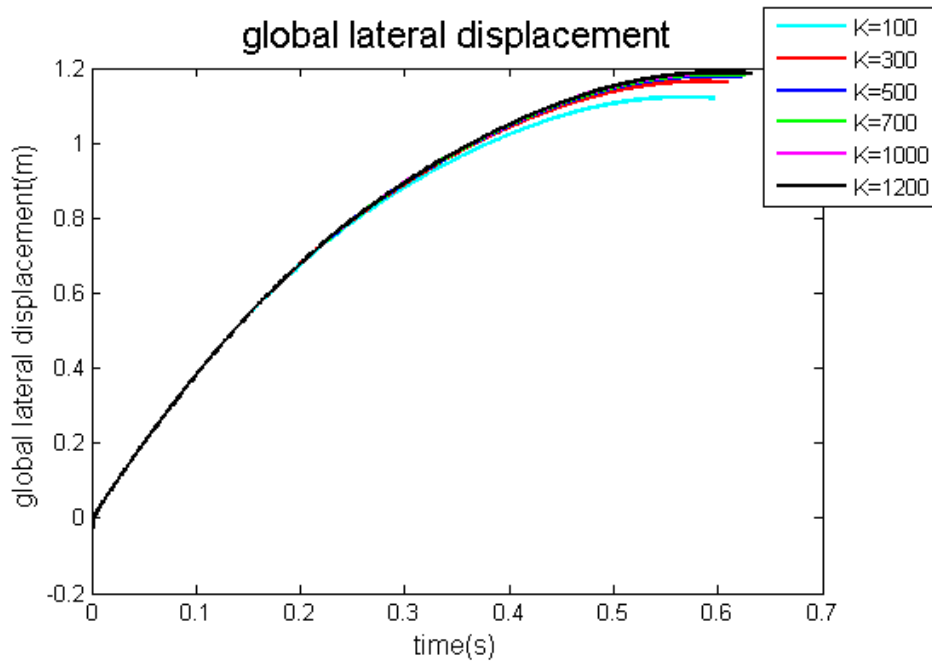

Figure 3.30 global lateral displacement

When yaw rate is from 2.4 to 3,  $K$  value has no influence for  $Y_{\max}$ , but vehicle with bigger  $K$  is more stable than lower  $K$ . But when  $K$  is bigger than 300, the influence for stability also becomes small. In Figure 3.31 – 3.33 shows one of the example, when yaw rate = 2.8:

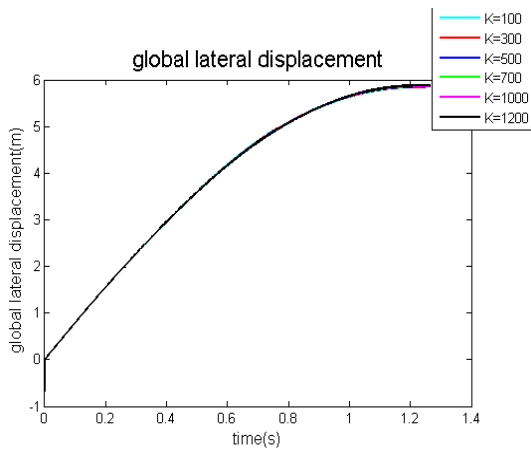

Figure 3.31 global lateral displacement

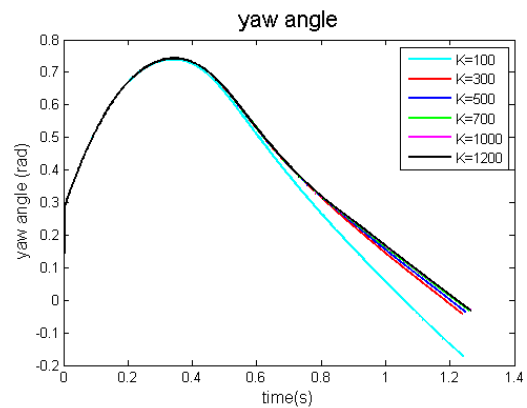

Figure 3.32 yaw rate

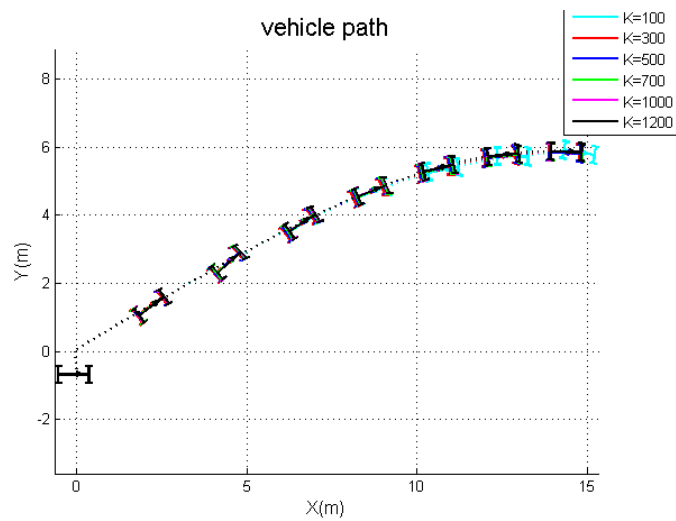

Figure 3.33 vehicle path

It can be seen from above, the value of  $K$  represents the influence of the ESC function to PISC function. It is the same as the comparison we made before, which is the comparison between PISC CM and PISC+ESC CM. The vehicle is more stable with bigger  $K$ .

Even so, it can be seen the influence of  $K$  value is still very small for the performance of PISC function, which we don't need to concern it.

In following research study,  $K=500$  is used for all cases.

### 3.3.2 $\lambda$ 's influence

In here, two different control strategies are compared, one is the  $M_z$  control, which is the strategy used above. It is continuously balancing the trade-off between global lateral force  $F_{yg}$  and yaw moment  $M_z$ . Another one is called  $F_{yg}$  control, it is instantaneously maximize the lateral force opposing lateral global deviation  $Y$ , which does not require online iteration and thus is simpler than  $M_z$  control strategy. The comparison result is showed in Figure 3.34:

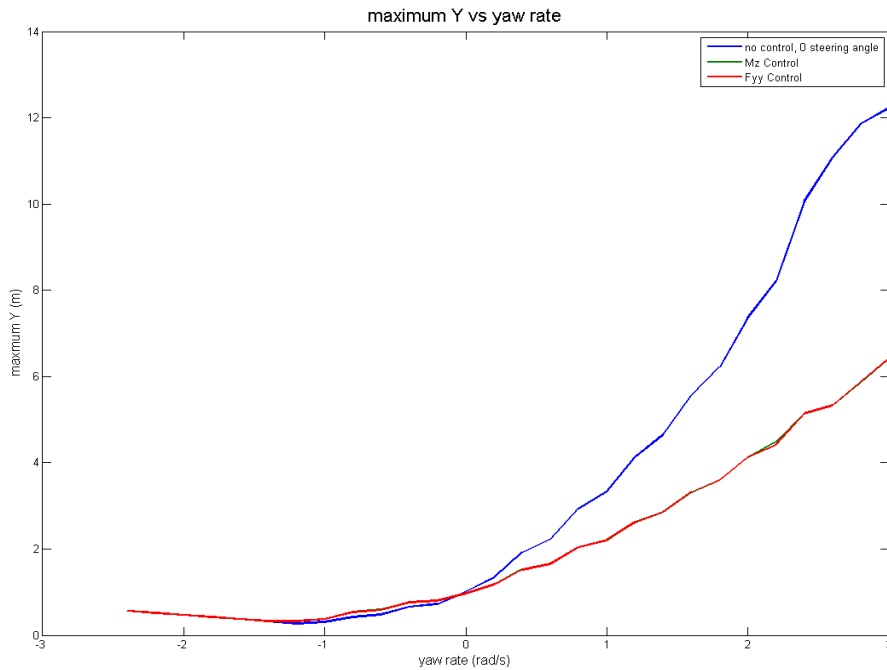

Figure 3.34  $Y_{max}$  vs yaw rate for both  $\lambda$

From Figure 3.34, it can be seen that there is almost no difference of these two control strategies for PISC performance in all initial yaw rate conditions. In Figure 3.35 and 3.38 also shows one of the examples,  $\frac{\lambda_4}{\lambda_2}$  in both control strategy in same initial condition and the vehicle states, which is when yaw rate = 1.6 rad /s:

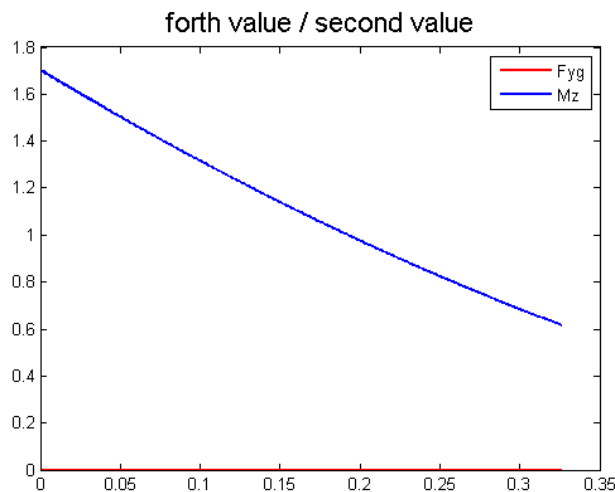

Figure 3.35  $\lambda_4/\lambda_2$

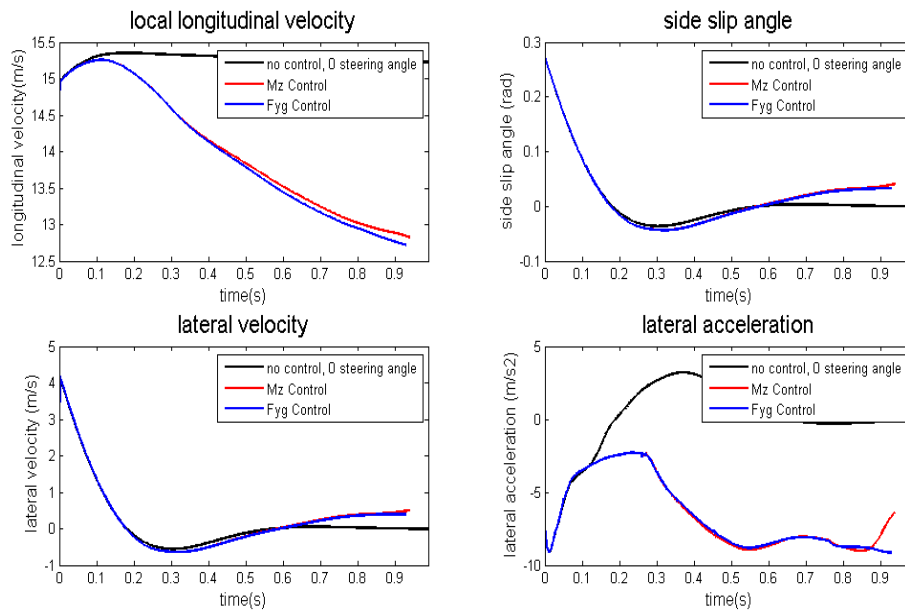

Figure 3.36 vehicle states comparison with two different  $\lambda$  set up

It can be seen that the ratio of  $M_z$  is very different as the  $F_{yg}$  but the vehicle states are almost same. Therefore, it can be concluded that the  $\lambda$  value has almost no influence to the performance of the PISC function. Hence, here in this thesis, PISC function is further simplified by only using the  $F_{yg}$  control component, instead of switching between  $M_z$  and  $F_{yg}$  components.

### 3.4 Verification with on-board systems.

#### 3.4.1 Performance when work with EPAS system

In previous chapters, it is assumed to use the steer-by-wire steering system, where the actual steering angle is the same as the desired steering angle from PISC function. In this section, the EPAS system is used instead of steer-by-wire steering system, the driver model in this case is assumed such that 0 steering wheel torque. Figure 3.37 shows how EPAS is implemented in the model.

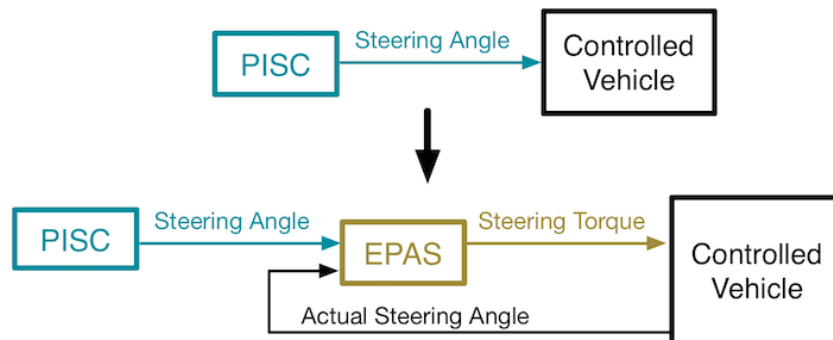

Figure 3.37 EPAS is implemented in the model

The performance of PISC for  $Y_{\max}$  is shown in Figure 3.38:

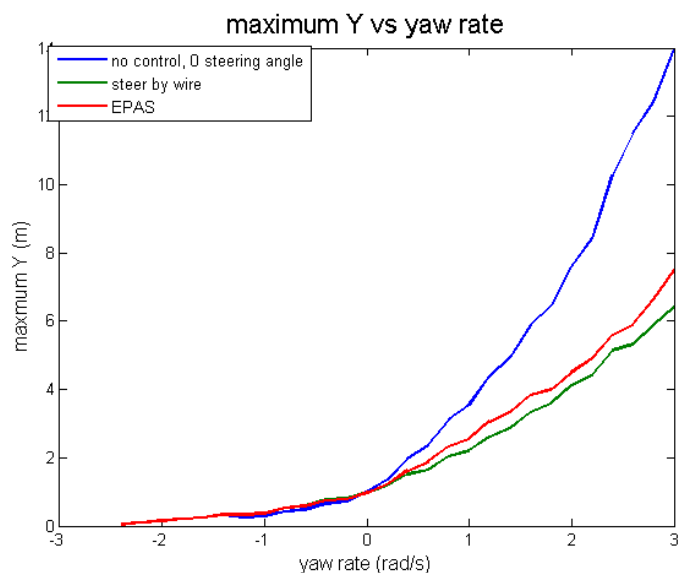

Figure 3.38  $Y_{\max}$  vs yaw rate

As predicted, performance with EPAS is worse than steer-by-wire, but the result is acceptable.

The reason for it is the difference between actual steering angle and the desired steering angle output from the PISC function when using EPAS steering. In Figure 3.39 and 3.40 shows one of the examples when initial yaw rate= 1.6 rad/s:

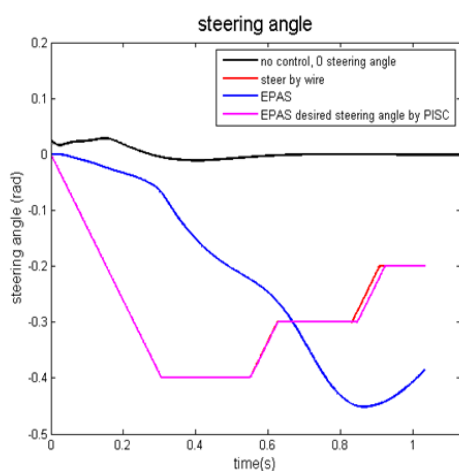

Figure 3.39 steering angle

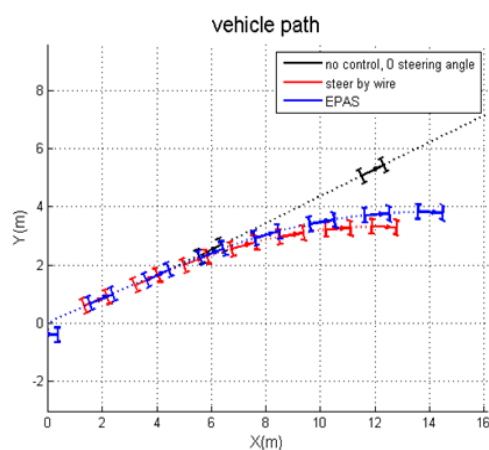

Figure 3.40 vehicle path

It can be seen that the actual steering angle can't follow the desired the steering angle (same as the actual steering angle of steer-by-wire) because of the EPAS system, this difference leads to a small difference of the vehicle path.



### 3.4.2 Replace simplified ESC with commercial ESC

In former chapters, the ESC function is very simple which is only considering the error of the yaw rate. In this chapter, the commercial ESC is used to test PISC's performance instead of the simplified ESC.

The test is conducted with and without ESC, respectively. The performance of PISC for  $Y_{max}$  is showed in Figure 3.41 and 3.42:

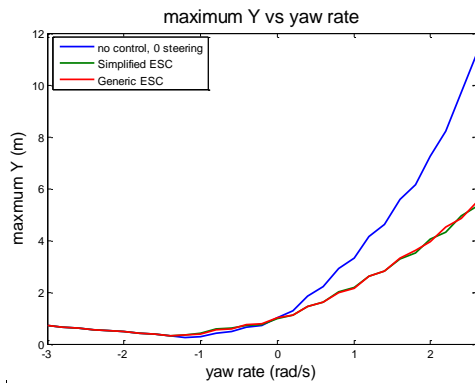

Figure 3.41  $Y_{max}$  vs yaw rate

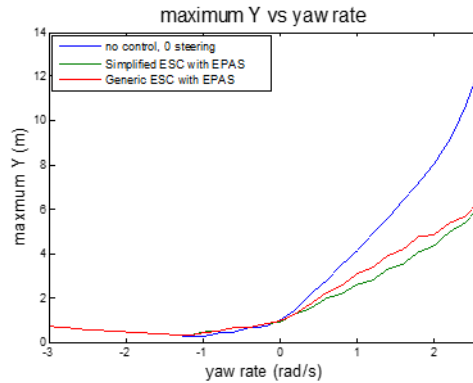

Figure 3.42  $Y_{max}$  vs yaw rate

The left Figure shows the comparison when use steer-by-wire steering, the right Figure shows the comparison when use EPAS steering. It can be seen that the industrial ESC performs almost same as the simplified ESC when only use steer-by-wire steering but becomes worse when use EPAS steering. The reason for it is showed in Figure 3.43 - 3.44:

This example is the initial yaw rate = 1.6 rad/s:

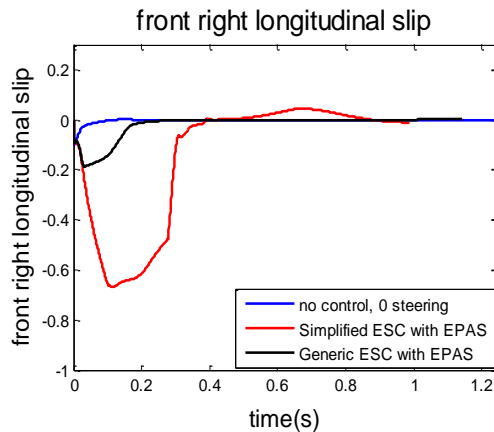

Figure 3.43 front right longitudinal slip

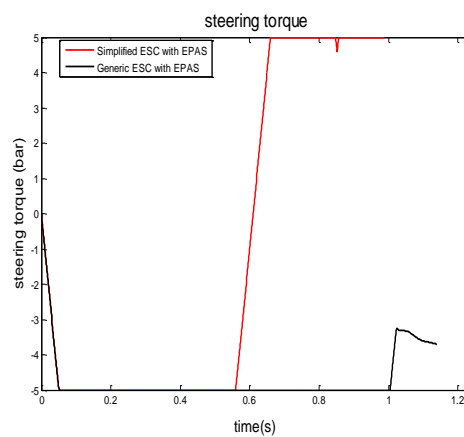

Figure 3.44 steering torque

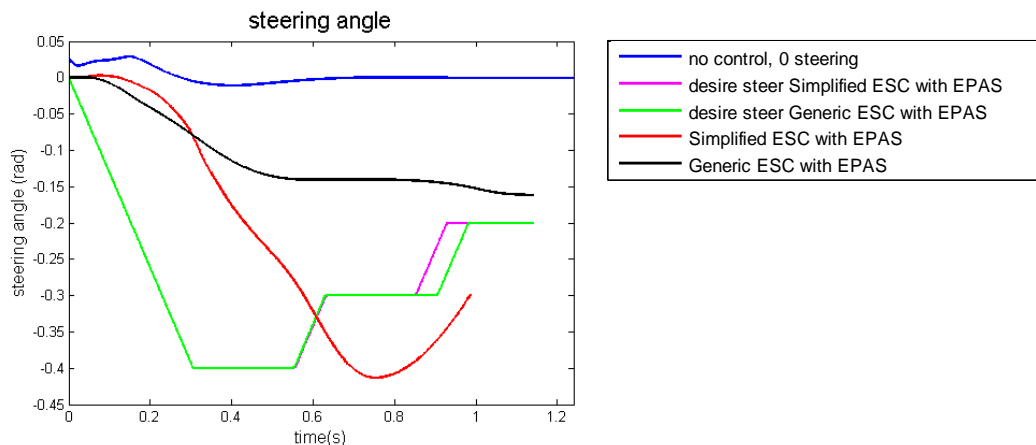

Figure 3.45 Steering angle

From Figure 3.43-3.45, it can be seen that the longitudinal slip limit of both ESC is different, generic ESC's longitudinal limit is around 0.15, which is much less than simplified ESC's 0.6 longitudinal slip limit. It also means the steering wheel's aligning torque of industrial ESC is much larger than simplified ESC. When steering torque from EPAS is same (both equal to 5 bar), the total steering torque (steering torque – aligning torque) of generic ESC is much smaller. Therefore, generic ESC's actual steering angle can't follow desired steering angle as quick as simplified ESC. Therefore, it can be concluded that one can increase ESC's longitudinal slip limit or EPAS's steering torque limit in order to enhance PISC's performance.

### 3.4.3 Compare with PIB function

In this chapter, the performance of PISC is compared with the PIB function with respect to  $Y_{max}$ . The result is shown in Figure 3.46:

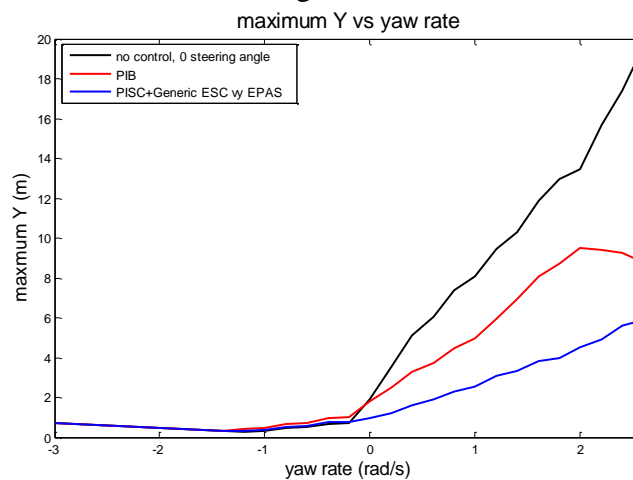

Figure 3.46 Ymax vs yaw rate

In Figure 3.47 also shows the vehicle path in one of the conditions (initial yaw rate = 2.6 rad/s) as the example:

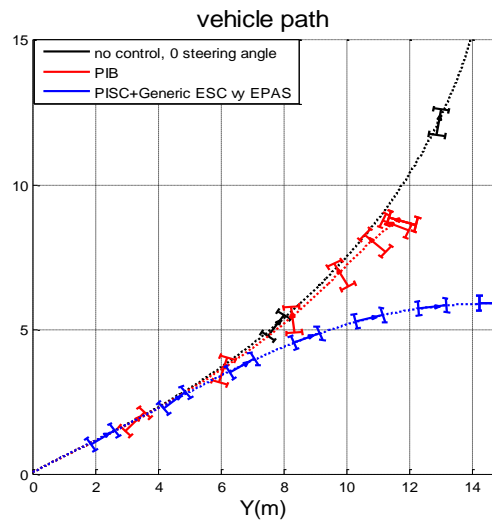

Figure 3.47 vehicle path

It can be seen from above plots, the PISC function performs much better than PIB function for both  $Y_{\max}$  and vehicle stability in all yaw rate conditions. But please notice the vehicle speed doesn't be considered here. The PIB's vehicle speed has been reduced to 0 in the end but the PISC's vehicle speed is still same as beginning.

### 3.4.4 Real signal update frequency

In previous chapters, the  $v_y$  is updated continuously in every simulation step, which is 0.001s. This is too fast update for most conventional vehicle today and probably 5-10 years ahead. The function execution periodicity is therefore increased to a more realistic value 0.01 s. The result is showed in Figure 3.48 and it is compared to the simulation with continuous updating:

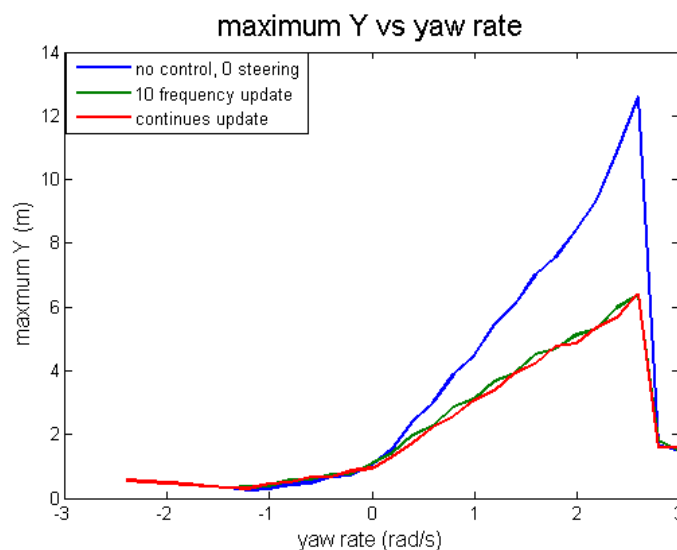

Figure 3.48  $Y_{\max}$  vs yaw rate

In Figure 3.49 – 3.50 below shows one of the examples, which is when yaw rate = 1.6 rad/s:

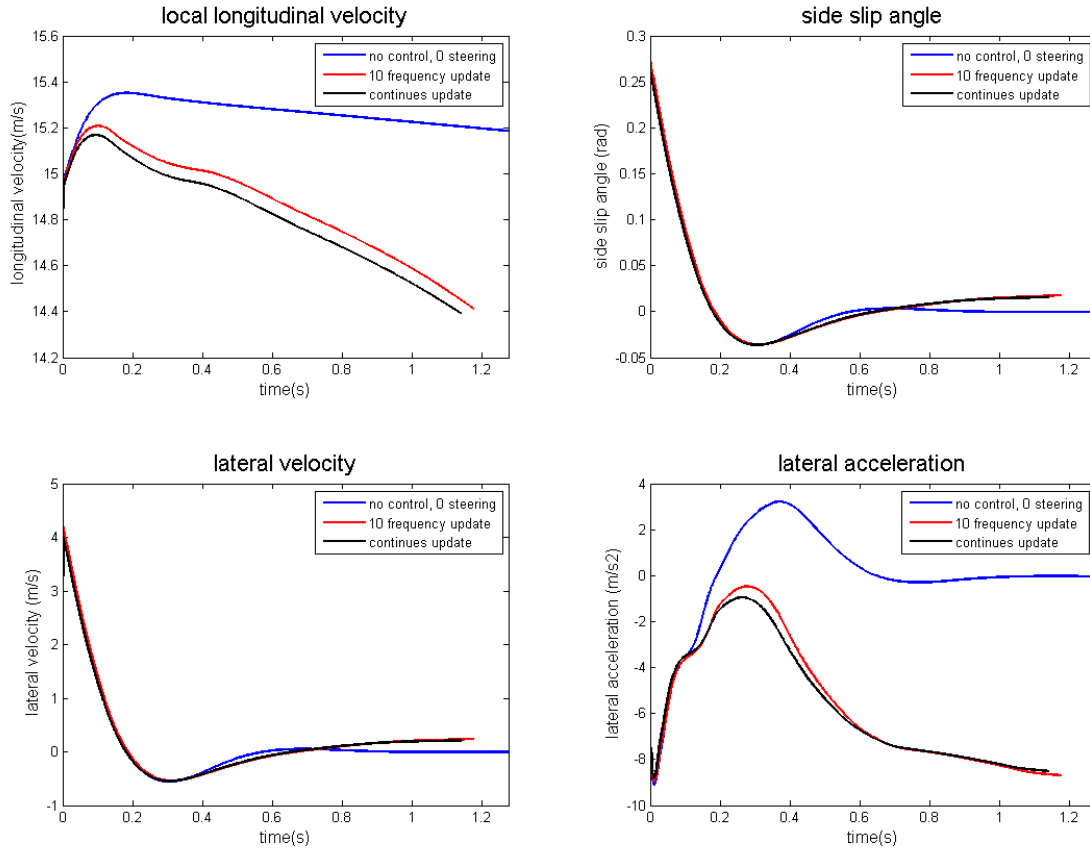

Figure 3.49 Vehicle states

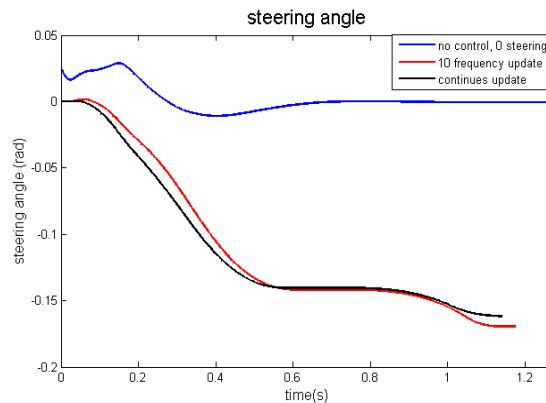

Figure 3.50 Steering angle

It can be seen that the steering angle given by PISC is a little different when updating is not continuous. So the vehicle states are also a little bit different. But the influence is not very big, the  $Y_{\max}$  is still almost the same in all conditions.

Therefore, it can be concluded that the PISC can use course-sampling rate that is common in nowadays production vehicle.

## 4 Test Matrix

In this chapter, the final model, PISC+ industrial ESC+EPAS Est with  $v_y$  update every 0.01s, ('PISC+ESC' is used to denote this model in this chapter) is test with different vehicle speed, different sideslip angle and different yaw rate. The performance is also compared with PIB, PIB+ESC and PISC+PIB+ESC function.

How PIB connects with ESC is showed as Figure 4.1.

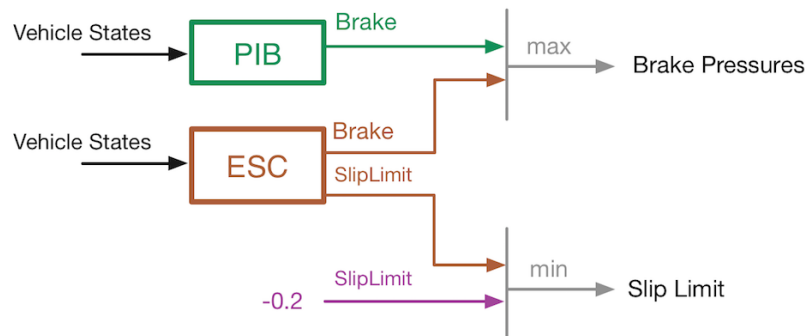

Figure 4.1

Vehicle's brake pressure is selected from maximum brake pressure between PIB output and ESC output. The slip limit is selected from minimum absolute slip limit between ESC output and ABS output (-0.2).

The PISC is connected with PIB+ESC to test if the performance becomes better when connect them together.

The test matrix is showed in Table 4.1:

Table 4.1

$v_x$ (km/h)	sideslip angle (degree)	$r$ (rad/s)
[40, 60, 80, 100, 120]	[0, 10, 20, 30, 40, 50]	[-2.4 : 0.2 : 3]

The comparison result for  $Y_{\max}$  is shown in Figure 4.2 - 4.6 in contour diagram, the contour lines are  $Y_{\max}$  value (-3m, 0m, 3m, 6m), abscissa is yaw rate (change from -2.4 to 3 rad/s), ordinate is sideslip angle (change from 0 to 50 degree).

When  $v_x = 40$  km/h

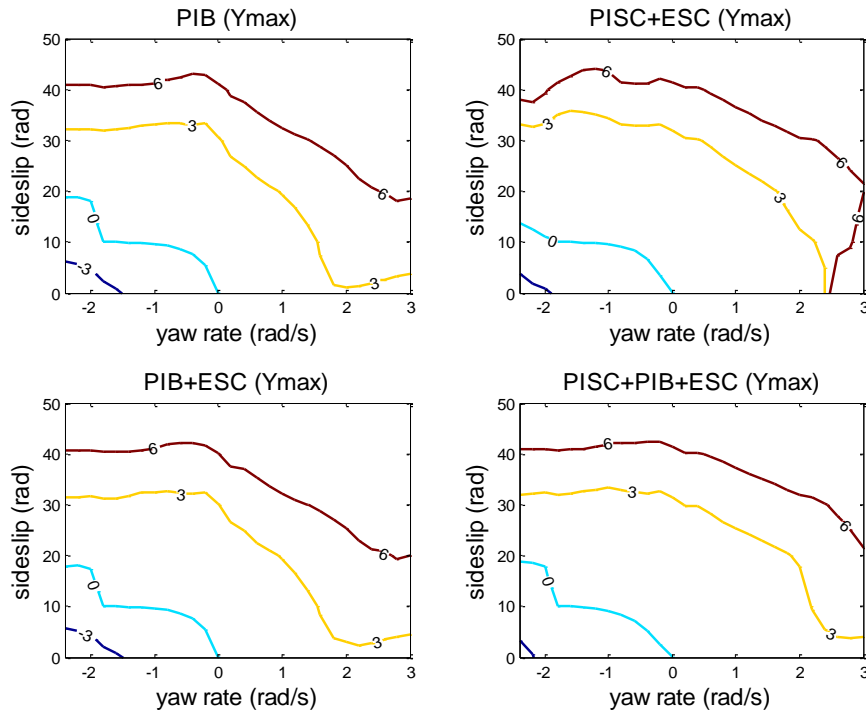

Figure 4.2  $Y_{max}$  Contour maps in  $v_x = 40$  km/h

$v_x = 60$  km/h

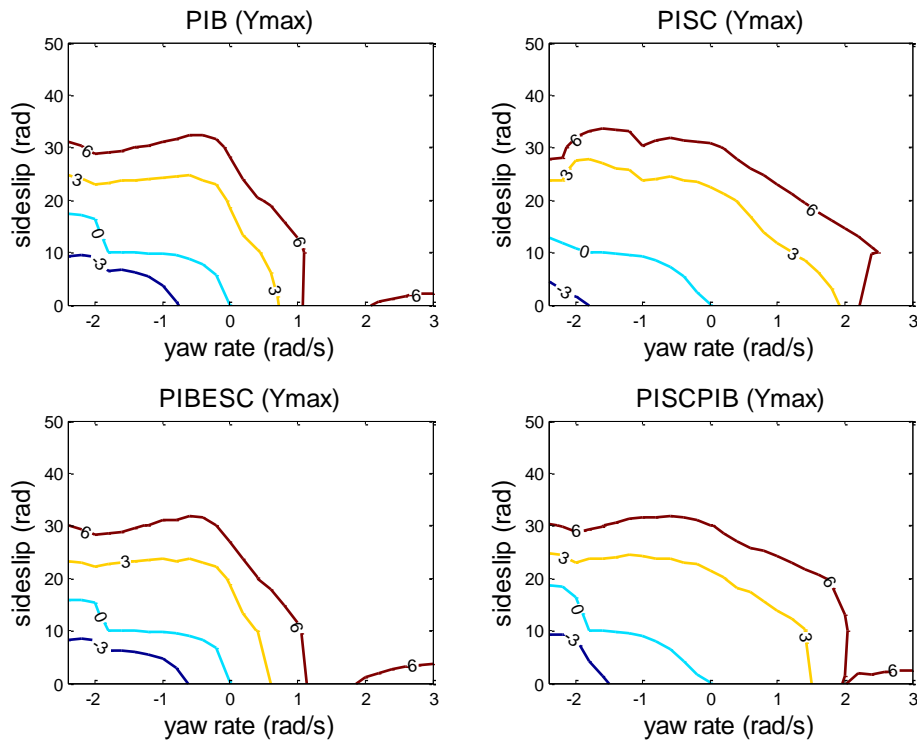

Figure 4.3  $Y_{max}$  Contour maps in  $v_x = 60$  km/h

$v_x = 80 \text{ km/h}$

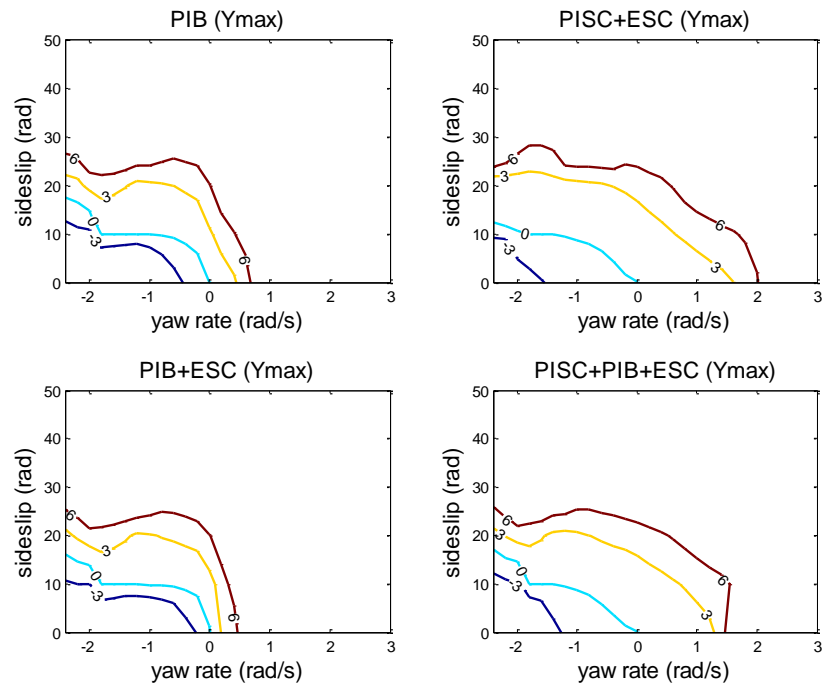

Figure 4.4  $Y_{max}$  Contour maps in  $v_x = 80 \text{ km/h}$

$v_x = 100 \text{ km/h}$

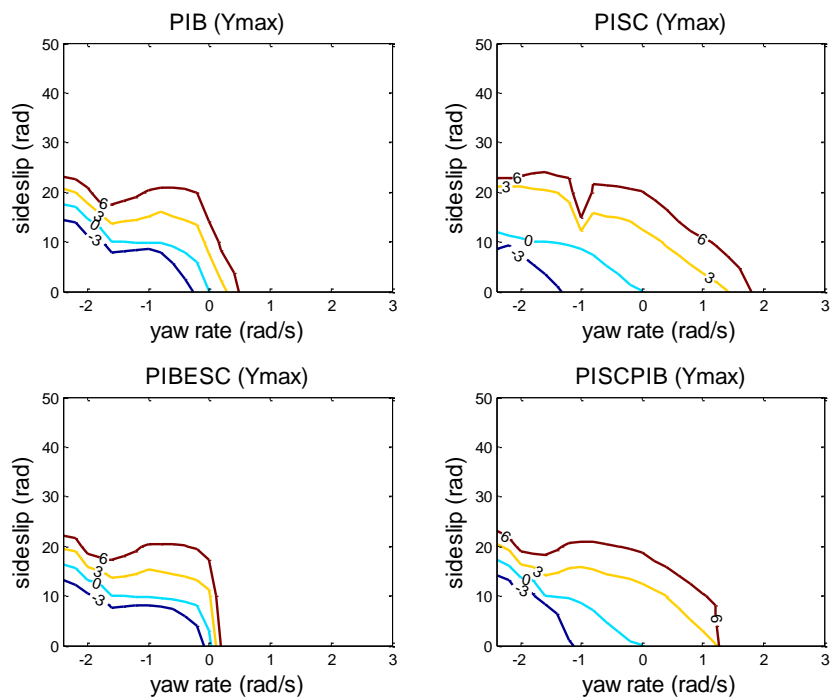

Figure 4.5  $Y_{max}$  Contour maps in  $v_x = 100 \text{ km/h}$

$v_x = 120 \text{ km/h}$

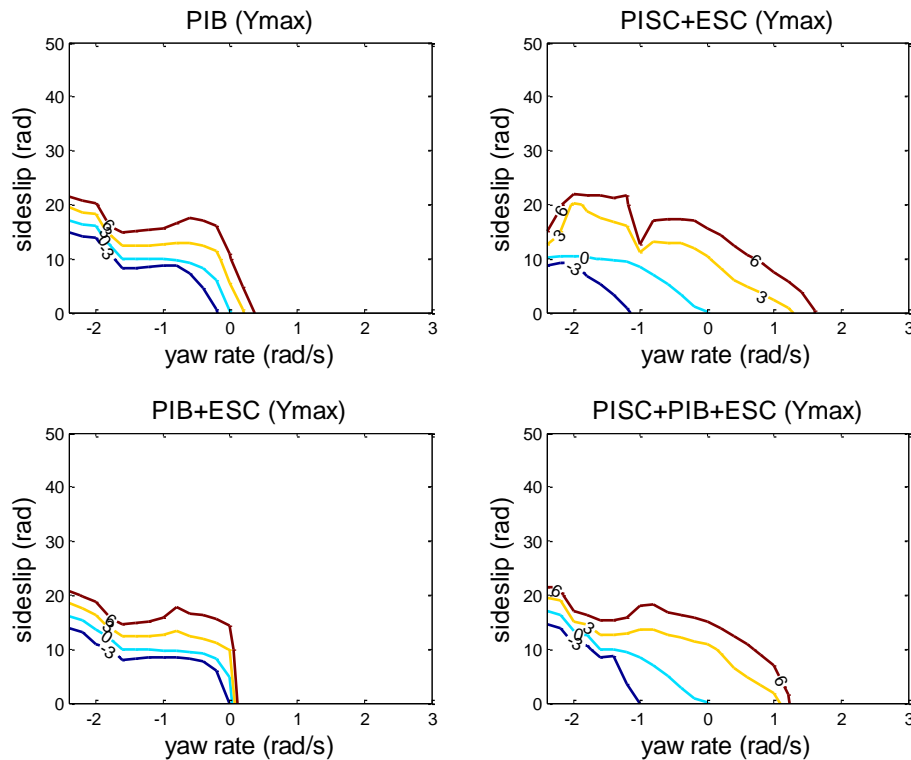

Figure 4.6  $Y_{max}$  Contour maps in  $v_x = 120\text{km/h}$

From Figure 4.2-4.6, it can be concluded that at lower vehicle speed, typically below 60kph, there is no obvious difference between PIB, PIB+ESC, PISC+ESC and PISC+PIB+ESC performance. Except when yaw rate is bigger than 2.6rad/s with sideslip angle smaller than 10 degree, PISC+ESC is not stable and performs worse than other 3 options. It is found the reason is because yaw angle is bigger than 90 degree during these conditions so it is out of the design condition of PISC function here. At higher vehicle speed, typically above 60kph, PISC+ESC provides better performance than 3 others with severer yaw disturbances.

It can also be seen from Figures above that adding ESC make PIB performance worse, especially at higher vehicle speed and yaw disturbances. Connecting PISC and PIB+ESC system helps to ease the unstable problem at high speed with specific yaw rate (-1 in Figures above), but in general, it does not perform better than PISC+ESC function.

Overall, PISC+ESC can provide best performance across a set of vehicle post impact kinematics.

But, one need to note, this is only one benefit measure, i.e.  $Y_{max}$  considered here. It is observed that PIB+ESC may introduce more yaw angle and side slip during the maneuver; and PISC+ESC may have higher vehicle speed than PIB+ESC, these factors should all be considered to evaluate the entire collision risk. To explain it, one



example is shown in Figure 4.7 and 4.8. The post impact condition here is  $v_x = 80\text{km/h}$ , sideslip angle = 10 degree, yaw rate = 1.4rad/s.

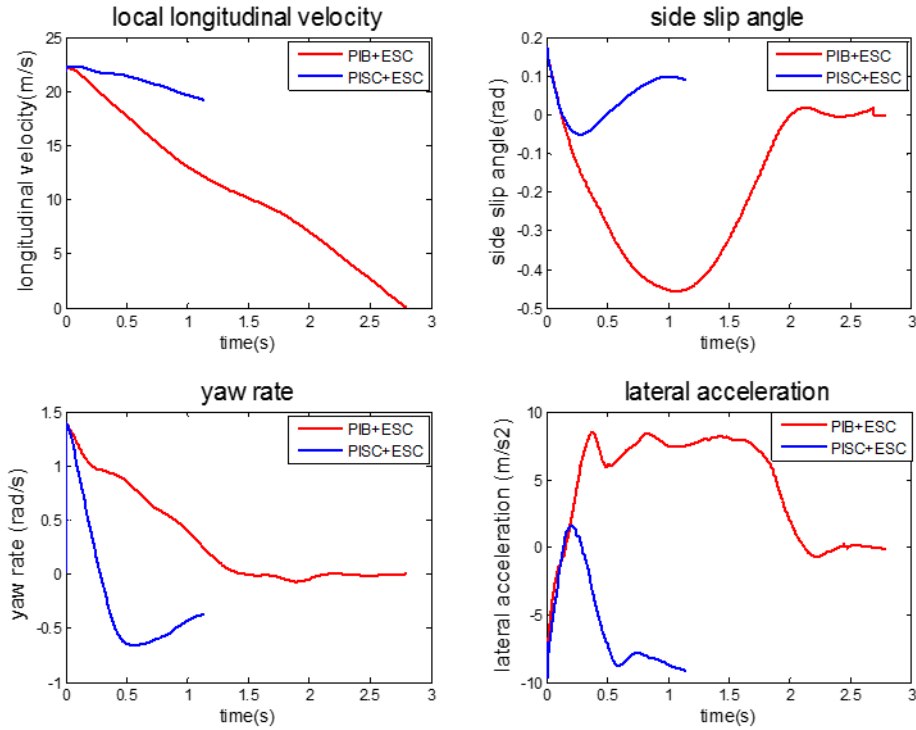

Figure 4.7 Vehicle states

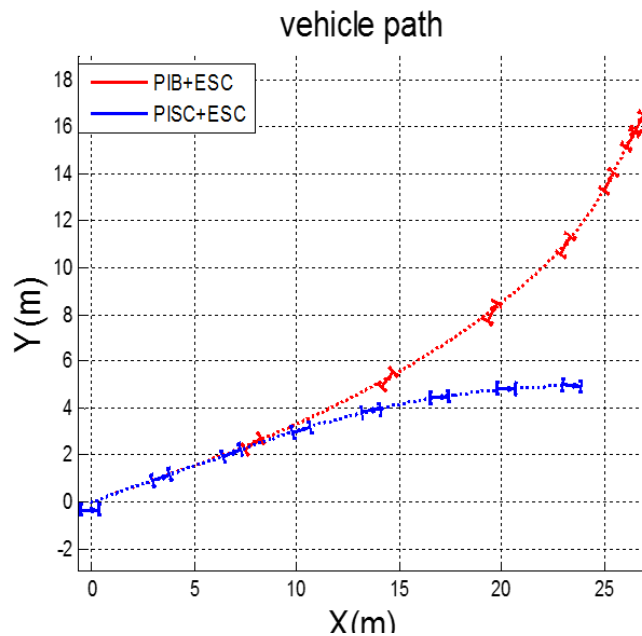

Figure 4.8 Vehicle Routes

From Figure 4.7, it can be found that PIB+ESC's longitudinal velocity is lower than PISC+ESC's, and PIB+ESC's sideslip angle is also smaller than PISC+ESC's. From Figure 4.8, it can be found PIB+ESC's yaw angle is larger than PISC+ESC's and it

can also be found that the vehicle with PISC+ESC function is also much more stable than vehicle with PIB+ESC function.

Therefore, after benchmarking with other relevant functions, it can be concluded that the vehicle with PISC+ESC function has smaller  $Y_{\max}$  and is also more stable in general post impact conditions. Above all, it is expected that PISC-like optimal path control function integrated with ESC-like stability control functions can be very promising in mitigating the multiple-event accidents.

## 5 Conclusion

The post impact stability control (PISC) function is found to work well with existing functions on-board, e.g. ESC and ABS functions. ESC has little adverse influence on  $Y_{\max}$  performance of PISC but it makes the vehicle more stable.

Using 3DOF vehicle model to estimate input signals to PISC instead of real vehicle states can make PISC failed in some conditions, but this problem can be solved by updating real lateral velocity signal to PISC function and the updating can be discrete. For industrializations simplification, the PISC function can be further simplified by removing  $\lambda$  control and it hardly influences PISC performance.  $\lambda$  control is a control strategy to select  $M_z$  control and  $F_{yg}$  control in different scenario.

If only use EPAS steering system instead of steer-by-wire steering, it will reduce PISC performance because the actual steering angle is not the same as PISC required steering angle. But the influence is acceptable.

ESC controller parameters such as gains have very little influence on PISC performance, therefore current generic ESC system can be used and the K value doesn't need to be redesigned for PISC. But if want to improve PISC performance more, there are still two aspects can be done to make PISC perform better. One is the current generic ESC longitudinal slip limit can be increased and the second one is the EPAS steering torque limit can be increased.

If compared to current PIB system, in common maximum road width (6m), PISC has smaller maximum lateral displacement and also make vehicle more stable.

In conclusion, PISC function performs well with ESC, ABS and EPAS system and it is proved by simulation that it can be integrated in real vehicle. Some vehicle states are needed as inputs. Most can be very easily estimated, but it can be expected that lateral velocity is challenging to be estimated precisely. Overall, PISC appears to be a promising function that can be relatively easy to integrate with other vehicle motion control function on board. It proves to a beneficial active safety function in avoiding or mitigating multiple-event accidents.

## 6 Future Work

In this thesis, the vehicle states (longitudinal velocity, lateral velocity, yaw rate and yaw angle) are directly changed to post impact states to simulate the post impact condition because it is easier and more systematic to post-impact vehicle dynamics simulation. It is also faster in computation. But it is not very accurate since there are still some states are not defined by this method, like vehicle roll angle, roll velocity etc.. More specific impact simulation method can be used to define the post impact states in future, like simulate all impact event, conservation of momentum etc.. PISC have 5 input signals (longitudinal velocity, lateral velocity, yaw rate, yaw angle and tire vertical load), only one is considered can be updated in this thesis. Actually, in current vehicles, longitudinal velocity and yaw rate are already very easy to get. Therefore, already today existing signals should be evaluated, to further reduce the need for new function design for PISC.

Only maximum lateral displacement is considered in this thesis as function performance criteria. But PIB may introduce more yaw angle and side slip during the maneuver; and PISC may have higher vehicle speed than PIB, these factors should all be considered to evaluate the collision risk. More vehicle states, like maximum longitudinal displacement, longitudinal velocity, yaw angle can be considered as the function evaluation criteria in the future. Related to this, a combination of PIB and PISC should be investigated, at least PIB could be used directly after maximum lateral displacement is reached, to secure that the positive effects of PIB is also gained with a new PIC concept, involving PISC.

The driver steering input is assumed as 0 in this thesis, but in actual situation, there must be some influence to PISC from driver's steering input. Therefore, the driver's influence needs to be considered in future work.

Only simulation is used to evaluate function's performance in this thesis and there are still many limits in simulation technology. Therefore, PISC's performance still needs to be tested in simulator or the real vehicle in future work.

The steering angle also can be sent from PISC to ESC, not from actual steering angle to ESC. It can be investigated in future work and it would probably trigger ESC earlier in the right direction.

## Reference

Bosch Automotive Technology (2014.8.29): How does ESC work? [Online]. Available: [http://www.bosch-automotivetechnology.jp/en\\_ja/jp/specials\\_3/specials\\_for\\_more\\_driving\\_safety\\_3/bosch\\_esp\\_4/esp\\_facts\\_8/esp\\_technik\\_4/esp\\_questions\\_and\\_answers\\_16.html](http://www.bosch-automotivetechnology.jp/en_ja/jp/specials_3/specials_for_more_driving_safety_3/bosch_esp_4/esp_facts_8/esp_technik_4/esp_questions_and_answers_16.html)

EURO NCAP (2014.8.29): *Audi secondary collision brake assist*. [Online]. Available: [http://fr.euroncap.com/fr/rewards/audi\\_secondary\\_collision\\_brake\\_assist.aspx](http://fr.euroncap.com/fr/rewards/audi_secondary_collision_brake_assist.aspx)

EURO NCAP (2014.8.29): *VW Multi Collision Brake*. [Online]. Available: [http://www.euroncap.com/rewards/vw\\_multi\\_collision\\_brake.aspx](http://www.euroncap.com/rewards/vw_multi_collision_brake.aspx)

IPG CarMaker. (2013): *Reference Manual Version 4.0.5*. IPG Automotive GmbH.

IPG CarMaker. (2013): *User's Guide Version 4.0.5*. IPG Automotive GmbH.

Kusachov A., Mouatamid F. (2012): *Post impact braking verification in motion platform simulator*. Master thesis. Department of Applied Mechanics, Chalmers University of Technology, Gothenburg, Sweden, 2012.

Liebemann E. K., Meder K., Schuh J., Nenninger G. (2004): *Safety and performance enhancement: The Bosch Electronic Stability Control (ESP)*. Convergence International Congress & Exposition On Transportation Electronics, 2004.

Naraghi M, Roshanbin A., Tavasoli A. (2009): *Vehicle stability enhancement – an adaptive optimal approach to the distribution of tyre forces*. Proc. IMechE Vol. 224 Part D: J. Automobile Engineering.

Yang D. (2009): *Method for benefit prediction of passenger car post impact stability control*. Master Thesis. Department of Applied Mechanics, Chalmers University of Technology, Gothenburg, Sweden, 2009.

Yang D. (2013): *Vehicle Dynamics Control after Impacts in Multiple-Event Accidents*. Ph.D. Thesis. Department of Applied Mechanics, Chalmers University of Technology, Gothenburg, Sweden, 2014.

Yang D., Gordon T. J., Jacobson B., Jonasson M. (2012): *Quasi-Linear Optimal Path Controller Applied to Post Impact Vehicle Dynamics*. In IEEE Transactions on Intelligent Transportation Systems, vol.13, no.4, pp.1586-1598, 2012.

Yang D., Jacobson B., Lidberg M. (2009): *Benefit Prediction of Passenger Car Post Impact Stability Control Based on Accident Statistics and Vehicle Dynamics Simulations*. In Proc. 21<sup>st</sup> International Symposium on Dynamics of Vehicles on Roads and Tracks, Stockholm, Sweden, 17-21, August 2009.

# Appendix

## Appendix A: PISC function in Simulink

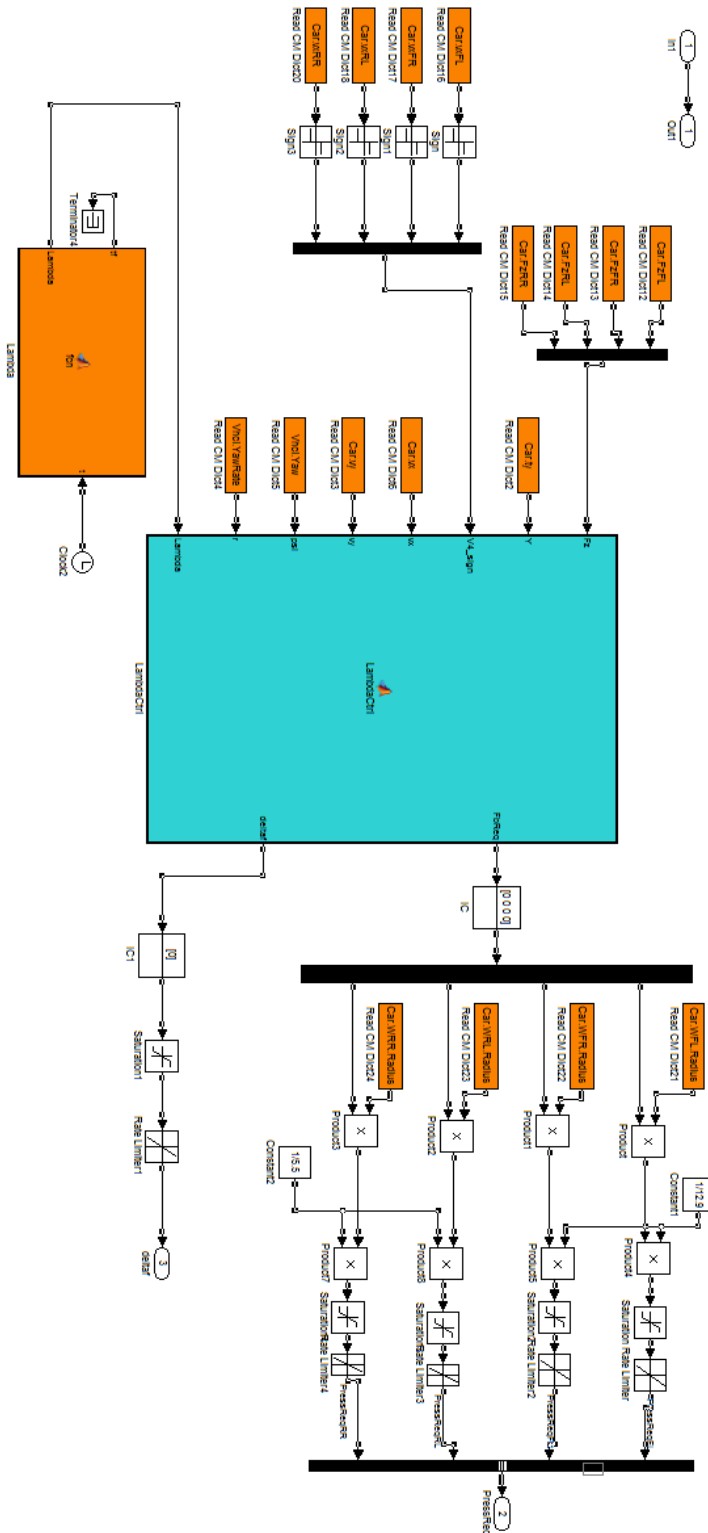

## Appendix B: ESC function in Simulink

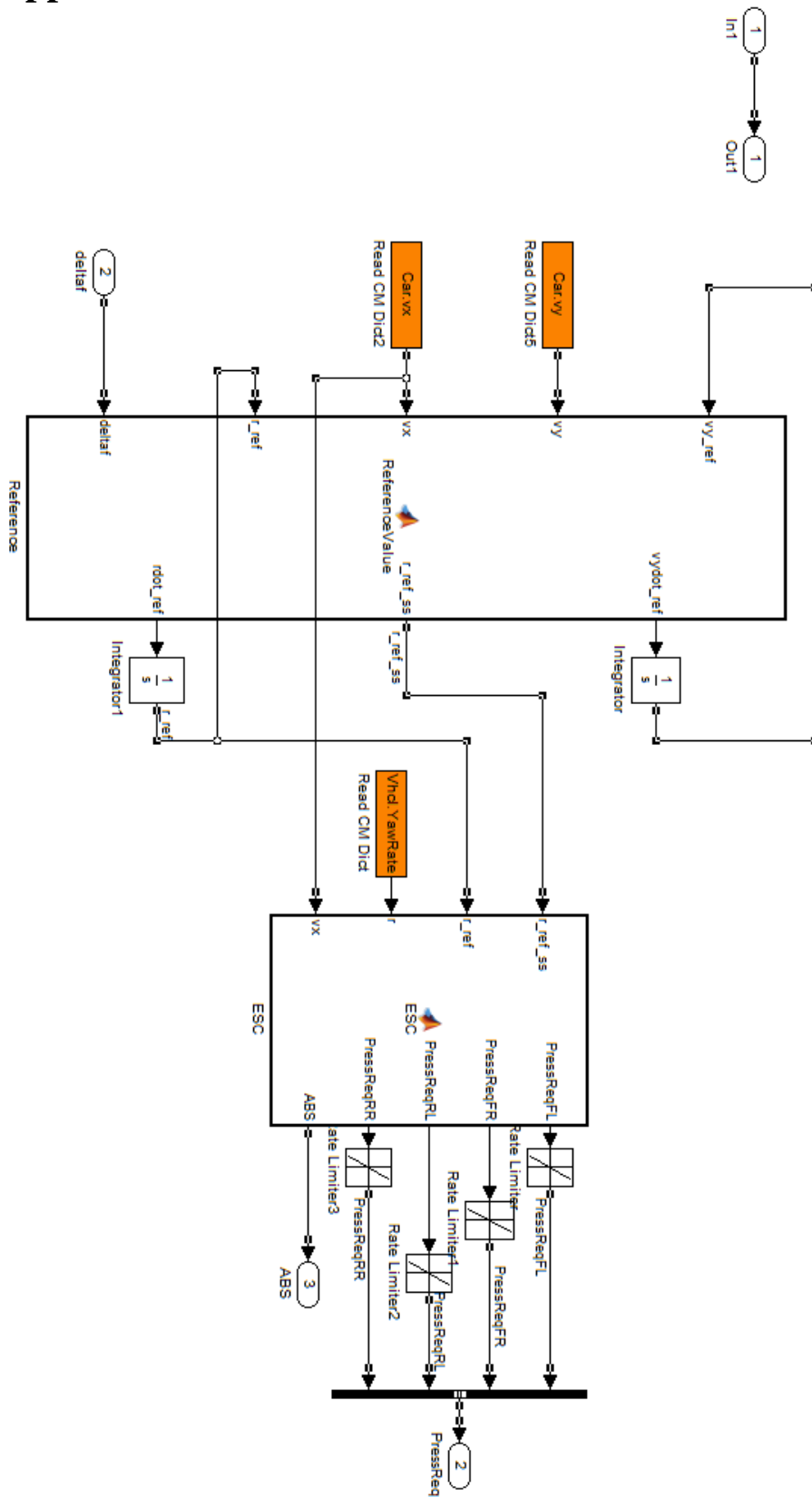

## Appendix C: PISC function further explanation

An important concept in PISC function is  $\lambda$ , which is a time-varying Lagrange multiplier vector adjoined to the constraints of the states equations. In the thesis, a simplified version of  $\lambda$  is used. It has four dimensions, corresponding to four states:  $x = [Y, \dot{Y}, \psi, \dot{\psi}]^T$ . This is based on the observation that X-dynamics have little effect on the forces and moments influencing lateral dynamics.

Another parameter used is the time when maximum path deviation occurs, denoted by  $t_f$ . It needs to be estimated and fed into  $\lambda$  calculator. If the time at  $\dot{Y}=0$  equals the  $t_f$  estimate, then is assumed to be correctly chosen. Estimate of  $t_f$  is made by the following equation,

$$t_{f0} = 1.5 \cdot \frac{\dot{Y}_0}{\mu \cdot g} \quad (1.1)$$

Where,  $t_{f0}$ : estimate value of  $t_f$ ,  
 $Y_0$  : Initial value of global lateral displacement,  
 $\mu$ : Friction coefficient of road,  
 $g$ : Acceleration of gravity.

The value of  $t_f$  has large effects on the control outcome of PISC function. If the estimated value is far away from real value, the vehicle even could fail to control. Thus, after the original calculation of  $t_f$ , several iterations will be taken, in order to get  $t_f$  close to real time that vehicle achieves its maximum path deviation. Then  $\lambda$  can be calculated based on  $t_f$  and real time for each simulation step. This type of control is called Yaw Moment Control ( $M_z$  Control), which is used to quickly limit both yaw velocity and side slip angle close to zero values.

There is another control strategy with fixed  $\lambda$  values [1 1 1 0]. It is called Lateral Force Control ( $F_{yg}$  Control), since it selects brakes to achieve the maximum force opposing the vehicle lateral motion in the road global coordinate. This control strategy doesn't need  $t_f$  to calculate  $\lambda$  for each simulation step, thus largely reduces amount of calculations.