

CHALMERS



Analysis of high frequency harmonics injected by wind turbines in a local grid

Master's Thesis in the Master Degree Programme, Electric Power Engineering

Jacob Eriksson

Department of Energy and Environment
Division of Electrical Engineering
CHALMERS UNIVERSITY OF TECHNOLOGY
Göteborg, Sweden, 2012

Analysis of high frequency harmonics injected by wind turbines in a local grid
Jacob Eriksson
Department of Energy and Environment
Chalmers University of Technology

ABSTRACT

This master thesis is conducted in cooperation with Götene Elförening, a local distribution company in Götene kommun. In this report, noise propagation focusing on high frequency harmonics is studied. The purpose of this study is to study if the used method of investigating the high frequency noise in Götene elförenings grid injected by wind turbines is adequate to get a satisfying picture of the noise situation. Furthermore, to study if the method provides a satisfying picture of the noise propagation and how the propagation itself affects the noise level. Consequently to evaluate if any means for harmonic mitigation are needed.

Measurements of voltages and currents are performed at three different locations, at two different wind turbines and at a point of common coupling. From these measurements a frequency spectra and curves of voltages and currents are produced. This is then used to calculate the total harmonic distortion (THD). Comparisons between different power levels and operation settings are then performed. According to the results of this study the level of high frequency noise injected to the grid by the wind turbines of interest are low. At the point of common coupling the noise is decreased to a neglectable level.

The conclusion of this study is that wind turbine installations containing power electronics in this specific grid does not cause power quality problems under the current conditions. Moreover it is found that the harmonics injected is so low that it was not possible to detect a difference when two various grid configurations were made during the measurements.

Keywords: High frequency noise, wind power, measurement, converter, total harmonic distortion

ACKNOWLEDGEMENT

I would like to dedicate my greatest gratitude to my supervisor Tarik Abdulahovic at CHALMERS UNIVERSITY OF TECHNOLOGY. Further I would like to thank Johan Lundquist and Leif Blomgren at Götene Elförening for giving me opportunity and help to perform measurements in their grid.

Jacob Eriksson

28th February 2012

ABBREVIATIONS

W - Watt

AC - Alternating current

PWM-Pulse width modulation

V_{ref} - reference signal

V_{tri} - triangular wave signal

VSC - voltage source converter

Hz -Hertz

PLC - Power line communication

THD - Total harmonic distortion

I_{s1} – Fundamental current

I_s – RMS value of the line current

A - Ampere

V - Volt

r.m.s – Root mean square

Z – Impedance

Z_g - Source impedance

Z_c - Impedance or the wind park

Contents

1	Introduction	3
1.1	Background	3
1.2	Purpose of the study.....	4
2	Technical background	5
2.1	Components of a wind power installation.....	5
2.2	Inverter systems.....	5
2.3	Harmonics	8
2.4	High frequency noise	8
2.4.1	Instability and damage.....	8
2.4.1.1	Power line communication	9
2.4.1.2	TV and radio disturbances	9
2.5	Total harmonic distortion	9
2.6	Description of the wind power connection- and the grid in Götene.....	9
2.6.1	Wind turbines.....	9
2.6.2	Grid.....	10
3	Method	12
3.1	Measurement point evaluation	12
3.2	Measurement equipment.....	12
3.3	Software.....	14
3.4	Measurements and results	14
3.4.1	Measurement at Enercon Wind turbine E82	14
3.4.1.1	Low production	16
3.4.1.2	Medium production	19
3.4.1.3	High production	22
3.4.1.4	Results from the Enercon E82 measurements.....	24
3.4.2	Measurement at Enercon Wind turbine E53	25
3.4.2.1	Low production	26
3.4.2.2	Medium production	30

3.4.2.3	High production	32
3.4.2.4	Result from the Enercon E53 measurements	35
3.4.3	Measurement at Point of common coupling.....	36
3.4.3.1	Normal operation, 20kV.....	36
3.4.3.1.1	Results: Induced noise level compared to noise level at point of common coupling	39
3.4.3.2	Decreased impedance, 20kV.....	41
3.4.3.2.1	Results: Decreased impedance, 20kV.....	43
3.4.3.3	Disconnected Källby cable, 20 kV.....	45
3.4.3.4	Disconnected Källby cable and phase compensation capacitor, 20kV	46
3.4.3.4.1	Results from disconnected phase compensation capacitor measurement	47
4	Conclusions	49
5	Future Outlook.....	50
6	References	51

1 Introduction

1.1 Background

The world's electric power production is mainly based on nuclear, hydro and fossil fuels. In the last decade, the global warming phenomenon has become more and more discussed. The use of fossil fuels at the current rate is found to be unsustainable. The electric power production methods of today have to be reformed and the proportion of the fossil fuel based power production has to be decreased drastically. The best alternative considered today is the production of electricity by renewable power sources such as wind, waves and solar energy. Due to a very high potential and very competitive price, wind power is becoming more and more popular. In the last decade the share of wind power turbines have increased significantly. Furthermore, the development of the wind turbines led to a significant increase in the power rating of the turbines. The turbines that are installed in Sweden today usually have a maximum power of 0.8-2 MW. But there are turbines with a maximum power of 6 MW that are available on the market.

It is clear that the development towards renewable energy sources has a positive effect on the environment, but there are the some issues related to this technology. Large electric power plants such as nuclear plants or hydro power plants are usually connected to the transmission grid while the wind turbines are often connected directly to the distribution grid. The problem is that the distribution grid is not intended for direct connection of power plants. This obviously causes some problems for distribution companies. Their grids may no longer be efficient for handling the power levels and keeping a good power quality in their grid. This problem varies from one location to another and a few case studies are performed in this work.

The focus of this work is the power quality of the power produced in the various wind power plants measured at different points. What distinguishes wind power from traditional hydro and thermal plants is the intermittent nature of this power source where the produced power is directly dependent on the speed of the wind. In nuclear plants and hydro power plants the power source is fairly easy to control and maximum production can be achieved according to grid requirements. This is not true for wind power where the production is dependent on the speed of the wind. This means that the power produced is directly proportional to the wind speed. In order to improve the efficiency of the wind turbines and make them operate efficiently during both low and high wind, power electronics is used in modern wind turbines. However, due to the nature of the power electronics, harmonics are injected in the grid.

In this work, the problem of high frequency noise injected by wind turbines to a local distribution grid is studied. The case study is conducted on a distribution grid placed in Götene kommun and owned by Götene Elförening. At this particular grid, a high number of wind turbines are installed; where 29 wind turbines are producing the total amount of 33.8 MW.

This study includes measurements and evaluation of the high frequency noise in the grid. The aim of this thesis is to study power quality issues caused by wind turbines. Furthermore, the thesis discusses the means of mitigations used to increase the power quality. The wind turbines in this particular grid are

quite spread out and measurements on all points of connections is not possible. For that reason, a part of the grid with particularly high density of wind turbines is chosen for the study.

1.2 Purpose of the study

The purpose of this study is to measure the high frequency noise in Götene elförenings grid injected by wind turbines. Furthermore, to study how it propagates and how the propagation itself affects the noise level. The purpose is also to investigate if the chosen method is adequate to evaluate the noise level and if any means for harmonic mitigation are needed.

2 Technical background

2.1 Components of a wind power installation

The system of a wind turbine connection is relatively simple. As Figure 1 shows, there are four main components. A rotor that converts linear movement of the wind into a rotational movement of the shaft. The rotor is in most cases connected to a gearbox and the gearbox to a generator. The grid connection most often consists of an electronic converter and in all cases of a transformer and a substation containing circuit breakers and measurement and control devices. If the wind turbine is directly connected to the grid, the rotor speed will be fixed to the frequency of the grid. This is a so called fixed speed turbine. When a power electric converter is included a possibility of effective speed regulation through frequency regulation is gained. This is a so called variable speed turbine. The use of power electric converters is usually recommended as the advantages are large. Variable speed is a necessity to enable the wind turbine to have a maximum power production at all times, with consideration of the wind. Other advantages are reduction of stresses on the power train, reduction of acoustical noise and improved power quality in the form of a more even production. The function of the converter will be further discussed in 2.2. [1]

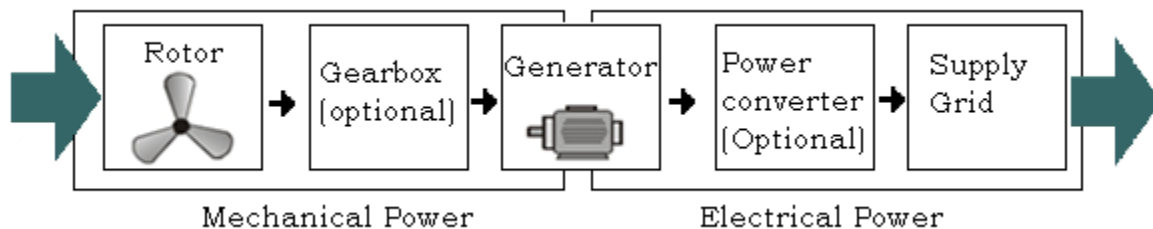

Figure 1: Main components of a wind turbine

2.2 Inverter systems

There are many sorts of inverters designs used for wind power but all of them are usually made using IGBT switches. Figure 2 shows an example of such an inverter setup.

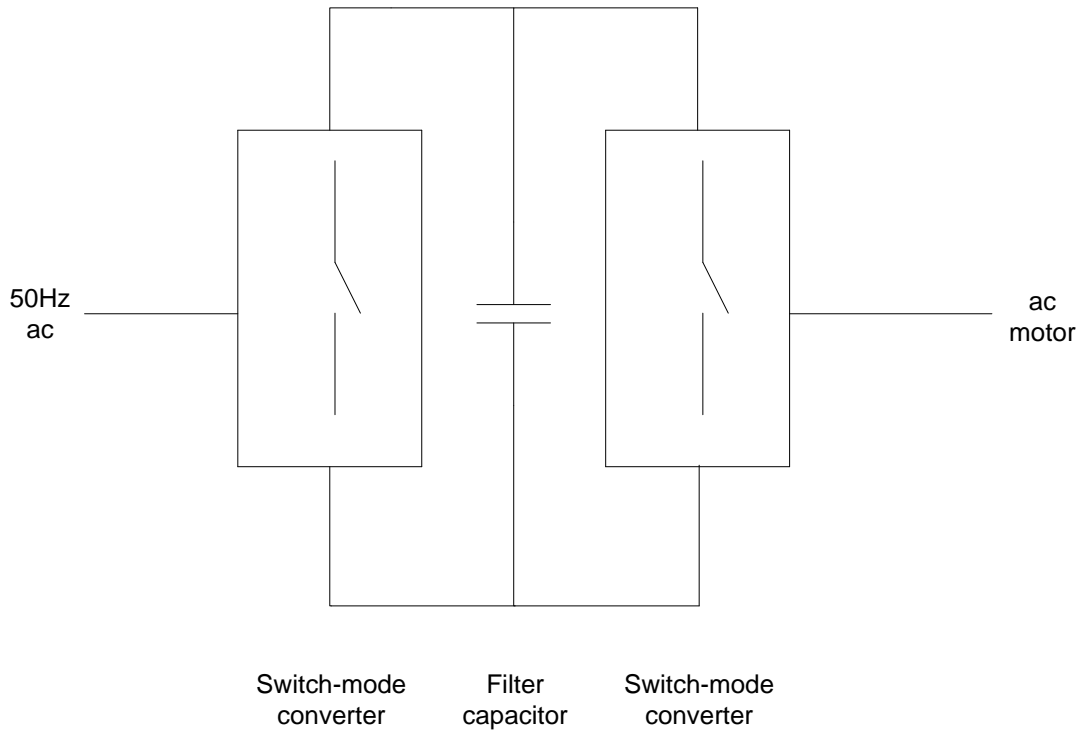

Figure 2: Example of inverter setup

The produced power is first inverted into dc and then inverted back to ac with the grid frequency. In Figure 2 an ac/ac converter is presented. The converter consists of two switch-mode inverters. The converter can have different configurations dependent on the characteristics that are required. The switches can be different. Either they are non controllable diodes that simply follow the potential differences and conduct when a positive voltage across the diode is applied, or controlled IGBT switches. In our case, where the converter is used for generative purposes, the switch-mode converter at the left side of Figure 2 can be replaced by a simple diode rectifier and still obtain the desired characteristics. But in the second switch mode converter, controllable switches such as thyristors are needed. [2]

The theory behind the controlled switching is relatively simple and various switching patterns can be used. One of them is PWM(pulse width modulation). A reference signal V_{ref} and a triangular wave signal V_{tri} are compared and the switches are set to operate by comparison of the reference signal and the triangular wave. To explain this let us consider a simplified example of the one-leg switch-mode inverter of Figure 3. The switches of the inverter in Figure 3 are controlled by a reference signal and a triangular wave signal of Figure 4a.

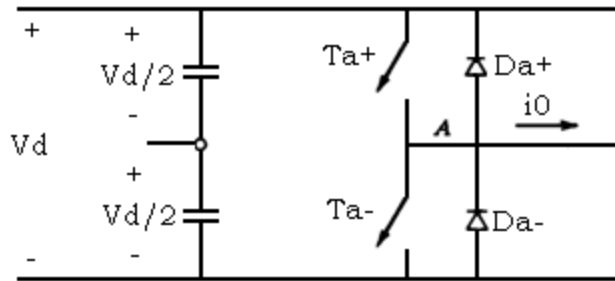
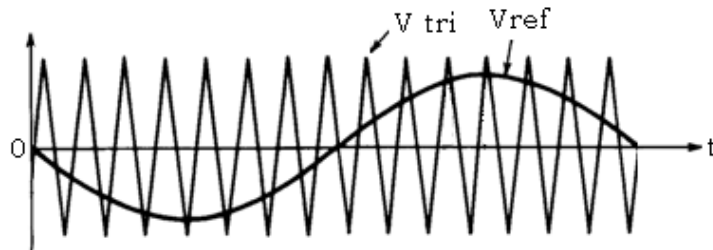
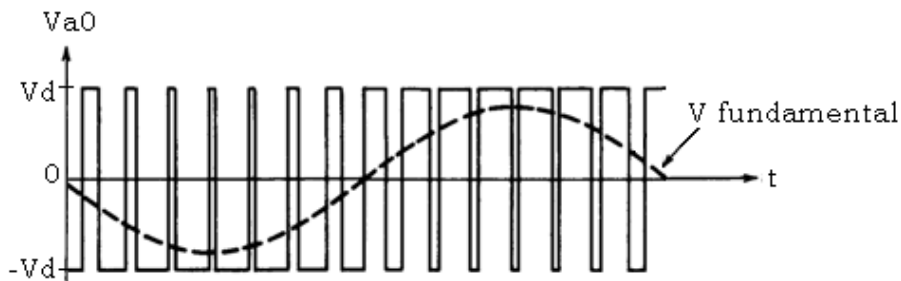

Figure 3: Inverter

When the triangular signal rises above the control signal, switch T_{A-} is on and switch T_{A+} is off. On the other hand, when the trigger signal is lower than the control signal, the operation condition is the other way around. This gives us square shaped voltage signal of Figure 4b. [2]



[a]



[b]

Figure 4 [a] Example of control- and triangular wave signal of a converter control system. [b] Example of voltage produced from a converter.

The control action of Figure 4a is used to explain the switching control of a so called Pulse-width modulated (PWM) inverter; there are also other kinds of control signal setups such as six-step operation, which in fact is an over modulated PWM.

Whatever switching technique used, the use of power electronic equipment with switching always leads to harmonic disturbances causing power quality issues in the grid. Both high- and low frequency harmonics are taken into account in this work, with special stress on frequencies of higher orders. [2]

2.3 Harmonics

As earlier mentioned, a power electronic converter is added to the wind turbine in order to meet the efficiency demands, but the power electronics also introduces some problems. If the connection is made through a power electronic converter, the produced supply voltage would not be perfectly sinusoidal. It might in fact be quite complex since it is produced by the switching action described in Section 2.2. Figure 6 shows how the shape of the produced voltage might look; where $V_{\text{fundamental}}$ is the fundamental signal. As can be seen in Figure 6, this is not the actual voltage curve, where the voltage consists of long and short voltage pulses with a magnitude of plus/minus V_d .

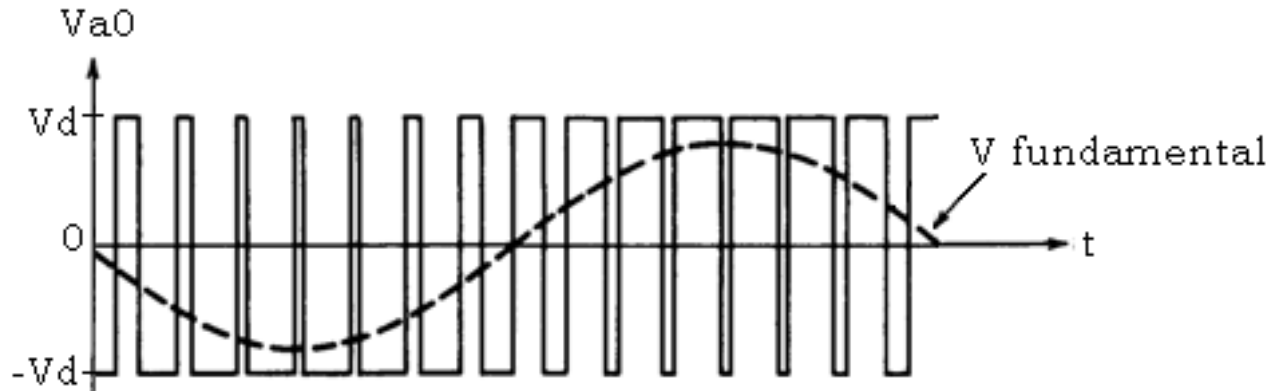

Figure 6: Example of voltage produced from a converter.

The fundamental frequency current is the only frequency that produces power that can be converted to useful power in customer apparatuses. During switching, more harmonics are produced. These are all integer multiples of the fundamental frequency and just generate losses.

Harmonics are not only produced by wind power units. In fact, all electrical equipment that contains power electronics produces harmonics. This means not only that power production produce harmonics but also loads that draw a non linear current from the grid produce harmonics. [2]

2.4 High frequency noise

In this work all harmonics are taken into account, but a special effort is made to include frequencies of higher orders. When referring to high frequency noise in this work, frequencies between 1 kHz and 40 kHz are considered. These are not only injected in to the grid by wind power connection but also by all electronic equipment that can be connected to the grid such as, photocopiers, computers, laser printers, air conditioning and so on.

2.4.1 Instability and damage

The list of problems related to high frequency harmonics is quite long; some examples are damage in electric motor bearings, malfunction of office equipment sensitive to power quality deteriorations and distribution transformer failures. High frequency noise may under certain circumstances cause cable insulation damage and ultimately cable failure.

The above mentioned may in some cases be extreme scenarios that may not occur on a regular bases in the present situation. In the future, the presence of power electronics and consequently high frequency noise in the grid is likely increase. It is thereby a highly interesting topic for distribution companies and grid owners. [3][4][5][6]

2.4.1.1 Power line communication

Electric grids have become more than just an electric power distribution system. It is now a communication channel referred to as power line communication (PLC). In Europe, the frequencies that are allowed to use for these purposes are 3 – 148.5 kHz. This is within the spectrum where high frequency harmonics are found. The system is used for collecting data on power consumption of consumers. This is naturally a system dependent on that the frequencies between 3 – 148.5 kHz are at disposal. This is maybe the most notable problem today related to high frequency harmonics, where the PLC system is suffering from interferences of high frequency noise. [7][8]

2.4.1.2 TV and radio disturbances

A characteristic that makes high frequency noise special compared to other disturbance in the grid is that these disturbances not only propagate in the actual grid but also in the air. This mainly has disturbances effects on radio and TV signals, which may get noisy. This leads to a noisy TV picture and a bad reception on radios. [9][4] This however is not the concern of this report and it will not be further discussed.

2.5 Total harmonic distortion

Calculations of total harmonic distortion (THD) results in a number indicating the RMS voltage/current equivalent of total harmonic distortion as a percentage of the total output RMS value of the fundamental. The THD can be expressed as follows:

$$THD_i = 100 * \frac{\sqrt{I_s^2 - I_{s1}^2}}{I_{s1}} \quad (1)$$

In (1) a current THD is expressed. A voltage THD is expressed by simply using voltage components instead of currents in (1). The THD is of high interest in this project and measurement results will be used to calculate this value. The Swedish standard SS-EN 50160 discussing voltage characteristics in public distribution system states that the maximum voltage THD should be below 8% in order to fulfill standard power quality requirements.[10]

2.6 Description of the wind power connection- and the grid in Götene

The grid in Götene is originally designed to be a distribution grid without power generating units. Lately, the growing interest for wind power in the region has led to a need for rebuilding the grid to be able to handle the increasing power production. This study is performed on a part of the grid where wind turbines are connected.

2.6.1 Wind turbines

Measurements will be done on two different wind turbines both made by Enercon, one of type E-82 and one of type E-53. Both wind turbines are structured according to the structure shown in Figure 7.

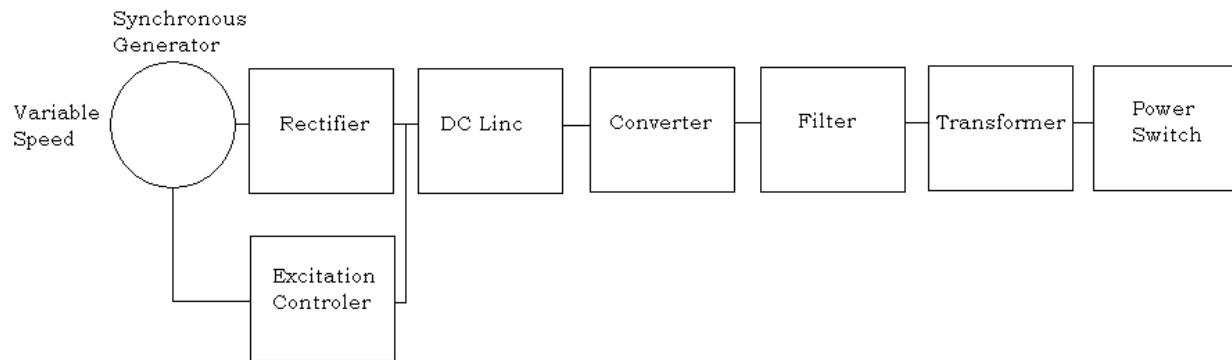

Figure 7: Wind turbine structure

The E82 is a 2000kW wind turbine with a rotor diameter of 82 meters and a stepwise optional hub height between 78- and 138 meters. It is equipped with an upwind rotor with three blades and active pitch control. The rotor speed varies between 6- and 18 rpm. The wind turbine is fitted with Enercons own direct-drive annular generator and their own Enercon inverter. This means, as can be seen in Figure 7, that the E-82 has no mechanical gearbox and is thus speed controlled only by the inverter. The turbine has an output voltage on the low voltage side of 400V and in our case, a voltage on the high voltage side of 20kV. The currents on the low voltage side have a peak value of 2886A. It also contains a low pass filter to filter out high frequency harmonics. The effectiveness of this filter will be studied in this project. While the so far mentioned features are standard, the transformer and power switch is optional to fit the site specific connection point conditions. [11]

The E-53 is an 800kW wind turbine with a rotor diameter of 52.9 meters and an optional hub height of 60- or 73 meters. The rotor is an upwind rotor with three blades and active pitch control. The rotor speed varies between 12- and 28.3 rpm. As the E-82 it also has one of Enercons own direct drive annular generators and an Enercon inverter and is thus without, mechanical gearbox. It has the same schematic structure as the E-82 and can thus also be seen in Figure 7. The voltage characteristics are the same as for the E-82 while the peak value of the currents on the low voltage side is 1154A. [12]

2.6.2 Grid

A large amount of the wind power in the grid is connected to point M3. This is a switchgear station with equipment such as, voltage transformers, current transformers, monitoring equipment, capacitors for phase compensation possibilities and circuit breakers. As can be seen in Figure 8, four transformers, two 10/40kV and two 20/40kV are included in the M3 switchgear station. One of the 10/40kV transformers is not used and acts as a reserve transformer. It can also be seen in Figure 8, that connections to the used 10/40kV transformer consists of a mixture of wind turbines and customers, where the turbines on this line are of the smaller type E-53. Connections to the remaining 20/40kV transformers are mostly wind turbines. This part of the system is a new part added to support the increasing expansion of wind power, and the turbines here are mainly of the larger type E-82. On the 40 kV side of the station shown in Figure 8 are two different connections, one overhead line towards the town of Götene and a cable towards the town of Källby. These connections are used for distribution of the generated power. The

connection setup shown in Figure 8 is the one used by Götene elförening. This is referred as normal operation.

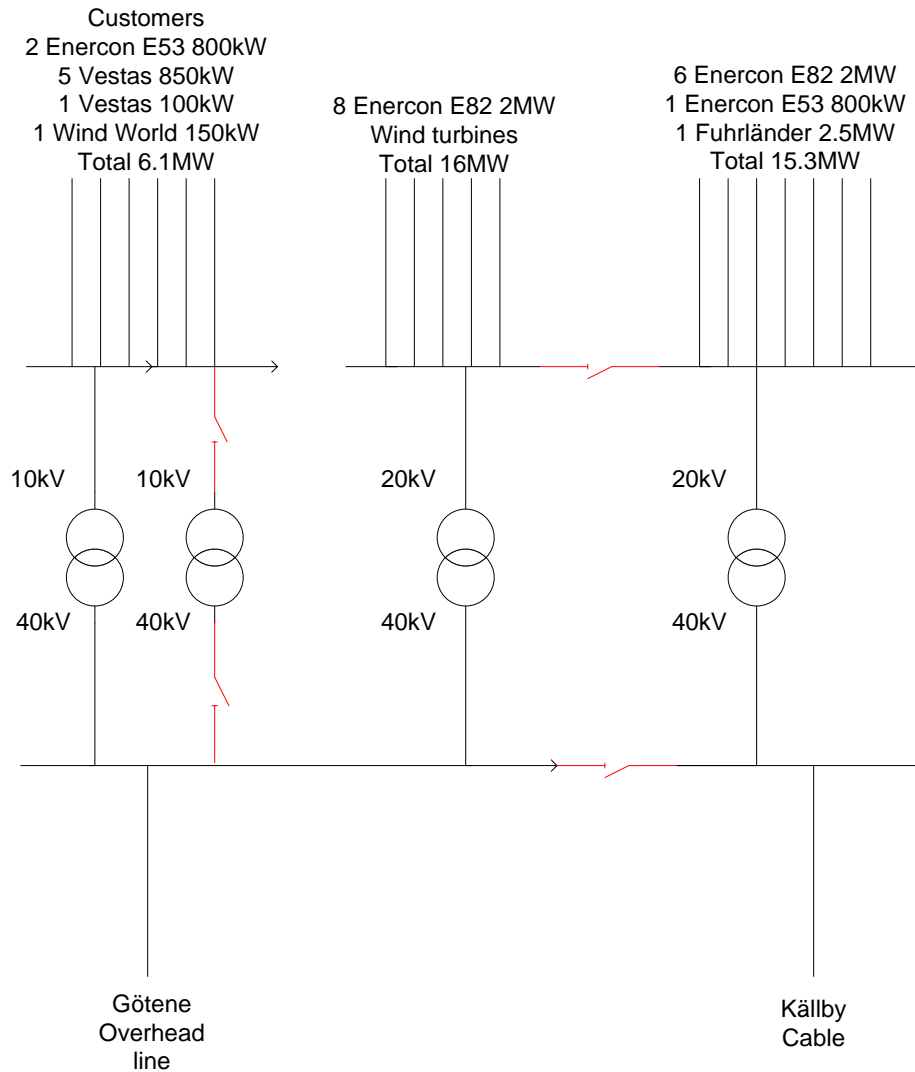

Figure 8: Structure of the M3 switchgear station under normal operation

Under normal operation both breakers on the 20/40kV side are open and thus there is no connection between the two distributing lines. According to the construction of M3, some of the power produced on the 20kV connections is distributed towards Götene and some is lead towards Källby.

3 Method

The results of this work are intended for a local distributions company and their main concern is not to improve the wind turbines. Their interests are aimed at insuring the power quality even though high frequency noise emitting wind turbines are present in the grid.

Now that the aim has been established new questions about the implementation arise:

- How can the spreading of high frequent noise in the grid best be investigated?
- What frequencies are considered?
- What kind of equipment is needed?

The frequency bandwidth of interest in this project is set to 500Hz-35 kHz to cover all frequencies considered relevant in the context of high frequency harmonics.

3.1 Measurement point evaluation

A method for investigation of the spreading of high frequency noise in the grid is to do a number of measurements and see the differences in noise levels at different points in the grid. Noise levels are affected by different characteristics of the grid but mainly by the number of transformers, which have a noise filtering effect, between the source of the noise and the connection points.

The first measurements that will be done is one of the voltages and currents on the low voltage side(400V) of the wind turbine. From this we can get the total amount of noise emitted from the converter. Though this result is not actually an accurate measurement of the emitted noise of the full wind power installation, the complexities of a high voltage side measurement were not possible in this project. This measurement will be carried out at two different wind turbines situated at two different locations in the grid. One connected to the 10kV line with costumers connected to the same bus as the wind turbines and one connected to the 20kV line through a bus with a few wind turbines.

The third measurement will be done on current transformers in the substation (10kV/40kV and 20kv/40kV). The current transformer frequency bandwidth is unknown but the measurement can still be used to calculate the power.

3.2 Measurement equipment

For the measurement a data collection system, voltage probe and current probes are used. The probes used are the LeCroy AP032 Differential voltage probe, the Flexible AC Current Probe, LEM flex RR3030 and the Teltronix P6015 high voltage probe, which can be seen in Figure 8, 9 and 10 respectively.



Figure 8: LeCroy AP032 Differential voltage probe

The voltage probe has a bandwidth of 25MHz which is well above the bandwidth required for this project; the maximum voltage level it withstands is $\pm 1400\text{V}$ or 1000Vr.m.s giving an out value of the measured value divided by 200 giving an out value of under 2 V.



Figure 9: Flexible AC Current Probe, LEM flex RR3030

The current probe has a bandwidth of 10Hz to 50kHz, also within our bandwidth limit of 500Hz-35kHz. The current range is 3000 amps and the output value is at maximum current 3V.

Figure 10 shows the last probe used, the Teltronix P6015 high voltage probe with a bandwidth of 75MHz and a voltage range up to 40kV peak. The output value is a division of the actual value by a factor of 1000. This probe is used in all measurements performed high voltage side.



Figure 10: Teltronix P6015 high voltage probe

In addition to these probes a good data collection system is needed. For this a six channel acquisition system is used, where all three phases on both voltage and current are rescored and saved as a binary code string. The computer has the ability to sample at a frequency of 60MHz which also well is above the frequency needed for this project. The software used is a LabView based program, which is adapted to fit this measurement setup in terms of channels, sampling rate, collection triggers and scaling. For longer measurements the system will be set to trigger automatically every thirty minutes and also by over or under voltages. For shorter measurements the system will be set to trigger continuously. At a trigger an 11 second long data file to the computer hard drive.

In addition to this equipment a continuous power supply is added in the power supply chain to ensure a continuous power supply.

3.3 Software

In this project all calculations are performed using Matlab. The six signals are loaded from measurement files, and scaling is performed to compensate for the scaling introduced by the measurement equipment and setup. The result is voltages and currents in all three phases with a very high resolution. These results are then used to find power levels, frequency spectra's of all harmonics and THD values.

3.4 Measurements and results

The measurements are preformed at three different stages. The first two stages is to measure on the low voltage side of two wind turbines and see what kind of noise levels are inflicted as a result of one wind turbine. And the third is a series of measurements at a high voltage point of common coupling, naturally located between the turbines and consumer.

3.4.1 Measurement at Enercon Wind turbine E82

The first measurement is performed on an Enercon E82 wind turbine shown in Figure 11. This is a turbine with a rated power of 2MW and an output voltage of 400V line to line.



Figure 11: Enercon E-82 wind turbine

The voltage measured in this case is the line to ground voltage. To be able to do the measurements the wind turbine is turned off, disconnected from the grid and grounded. The three LeCroy AP032 probes are then connected to one conductor each and the same is done with the LEM flex RR3030 current probes. In order to get the whole range of production the measurement is performed constantly over a week with variable weather conditions.

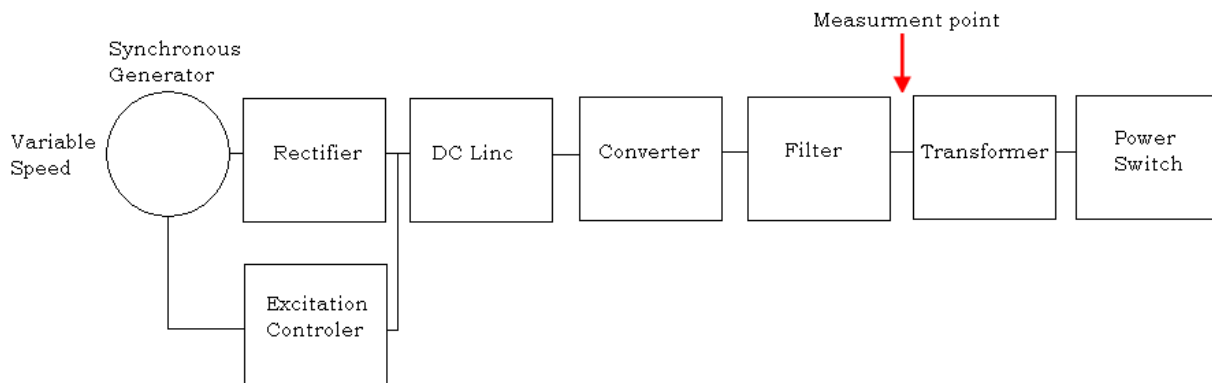

Figure 12: Wind turbine structure with the measurement point

As can be seen in Figure 12, the measurement is performed after the rectifier and converter since this is the part where the noise is injected. The transformer filters away some of the noise, but a high voltage

measurement is not performed in this project. Instead, the transformer filtering function will be presented using THD calculations. This is simply done by filtering out the third harmonic from the measured signal. To conclude, this gives us the harmonic levels that are actually inserted in to the grid after the transformer. This measurement is intended to give a view of the harmonics inserted in to the grid depending on how much power is produced by the turbine.

3.4.1.1 Low production

We start by looking at the low production of around 83kW which is approximately only 4% of the maximum power production of 2MW. We have a look at the THD before and after the transformer, this is only done in this case to show the difference. Later values discussed will show THD recorded after the transformer.

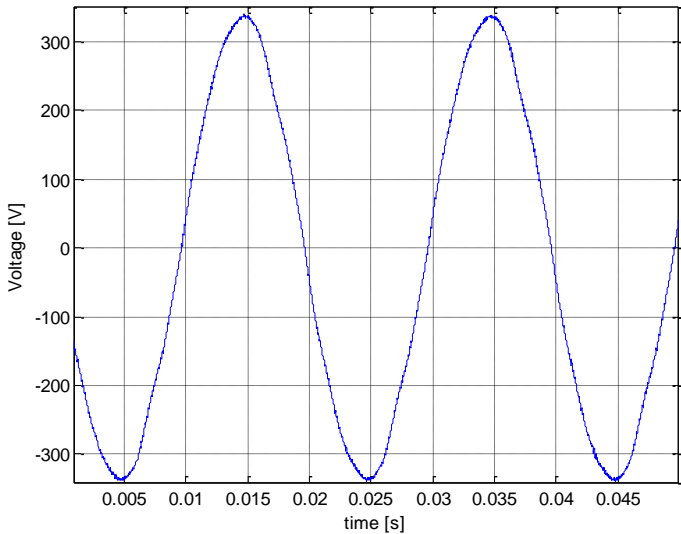

Figure 13: Voltage at low production

Figure 13 shows the wave forms of the first phase voltage before the transformer. As can be seen, the voltage has the characteristics of an almost ideal sinusoidal form. A more interesting figure is Figure 14 showing a closer zoom of figure 13. The voltage seems to be a bit noisy but nothing extraordinary. A good measure of the noise level of the voltage is the voltage THD which in this case is 1.64%, a value that is considered very low.

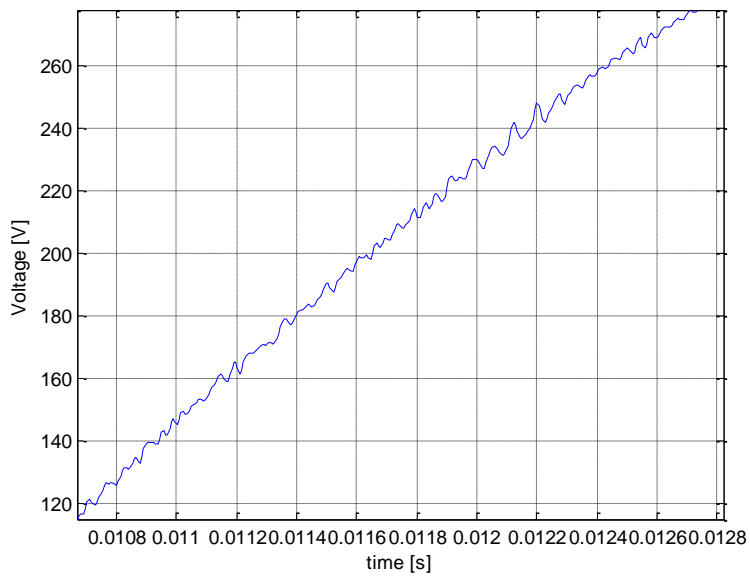

Figure 14: zoom of voltage at low production

We now have a look at the voltage THD after the transformer which in this case is 1.63%. Let us observe current harmonic in Figure 15 which shows the waveform of the current. The fluctuations of the current are quite expected as the production rate is low making the noise of from the power electronics more notable.

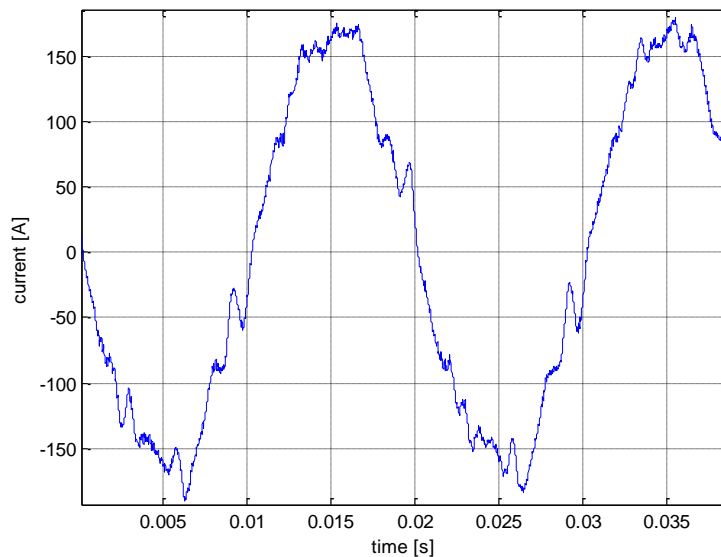

Figure 15: Current at low production

Looking at the zoom of the current plot in Figure 16 we can clearly see the noise in the current. Again, to get a better overview of the noise levels we observe the THD. This time the current THD before the transformer is 7.77% and after 7.49%. Once again we see that the transformer affects the noise.

These numbers are obviously higher than the one for voltage THD. As mentioned before, one can expect the current THD to be higher at low production rate, but the effects of the distorted power at low production are low.

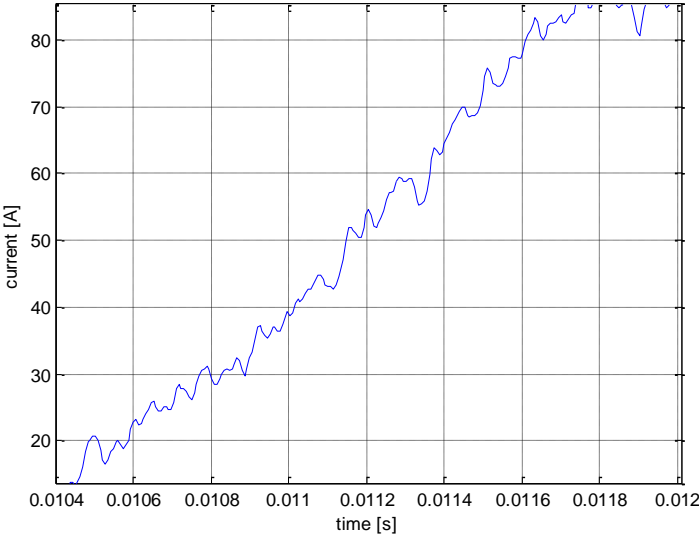

Figure 16: Zoom of current at low production

So far, the THD value has been used to quantify noise, but the objective of this report is not only to establish the general level of noise but to investigate how the noise of higher frequency propagates throughout the grid. Therefore we take a look at the frequency spectra of this particular measurement.

As can be seen in Figure 17, in the frequency spectra it is found that the interesting high frequency noise is located around 23.8 kHz. The voltage has been normalized from a fundamental value of 330V to one of 1pu.

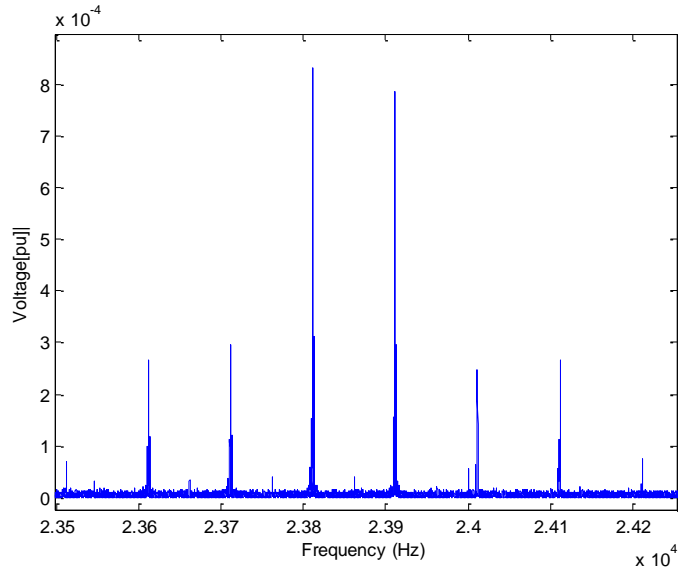

Figure 17: Frequency spectra for high frequency voltage noise at low production

Figure 18 shows the same noise but in this case for the current, once again normalized to a fundamental value of 1pu.

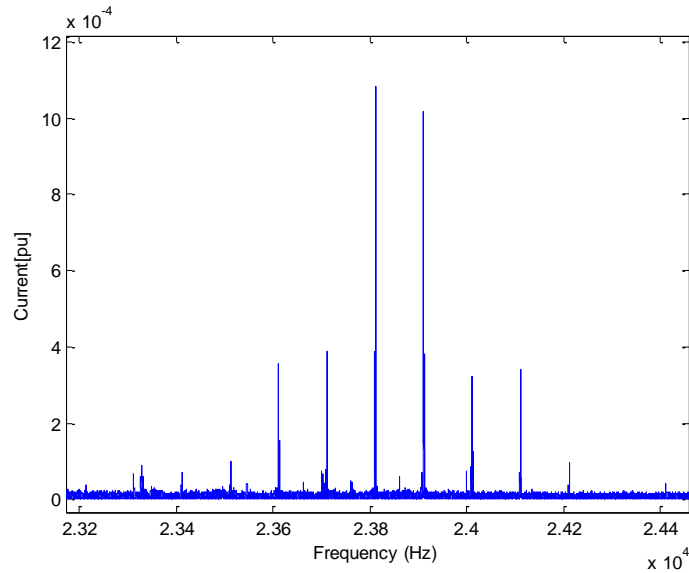

Figure 18: Frequency spectra for high frequency current noise at low production

3.4.1.2 Medium production

We now look at a case of medium production, to be more specific the generation in the chosen case is approximately 1.079MW which is just under 54% of the turbines maximum generation possibility. As the full period curves do not offer much difference for the voltages we now move straight to the zoom of the voltage seen in Figure 19.

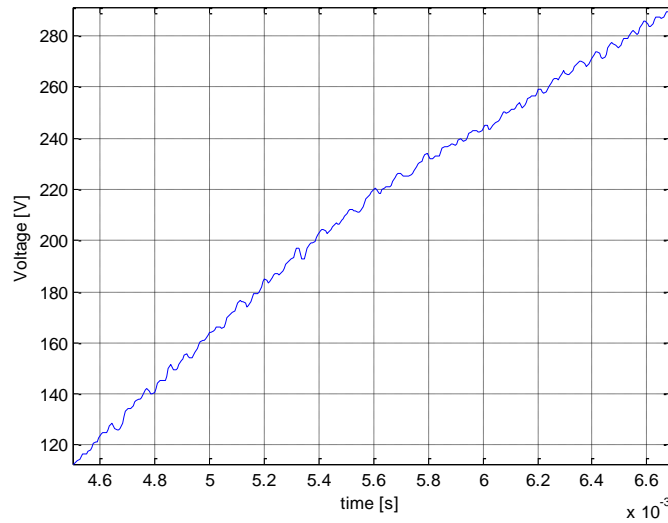

Figure 19: Zoom of voltage at medium production

Once again we see the noise in the curve and have a look at the voltage THD to see the level. In this case the voltage THD is 1.21% which is lower than the value from the low production measurement.

We have a look at the current curve in Figure 20 and see that the shape is significantly better than at low generation, we have a look at the zoomed current curve of Figure 21 and see that the noise is practically gone. This is also reflected in the current THD which in this case is only 0.92%.

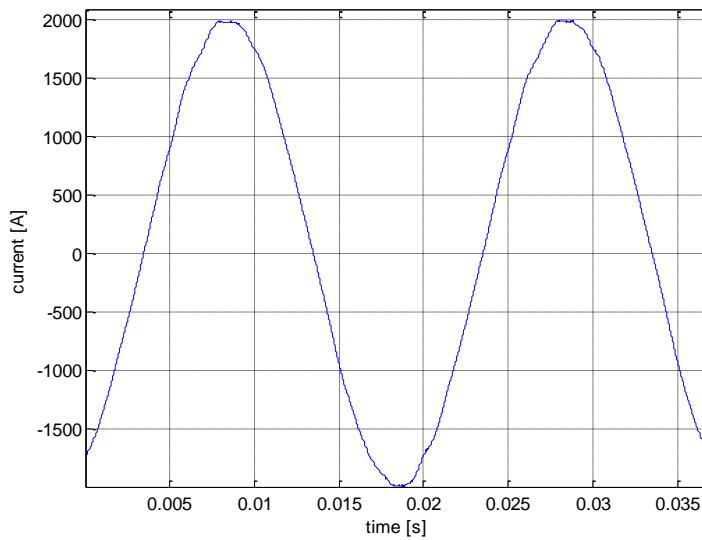

Figure 20: Current at medium production

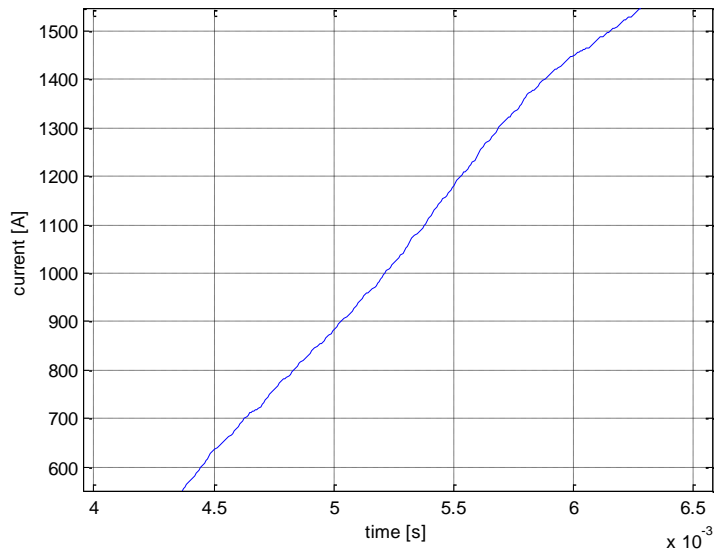

Figure 21: Zoom of current at medium production

Finally let us once again have a look at the high frequency noise. We start with the normalized spectra of voltage harmonics in Figure 22. It can be seen that the harmonic level is slightly lower than in the previous measurement.

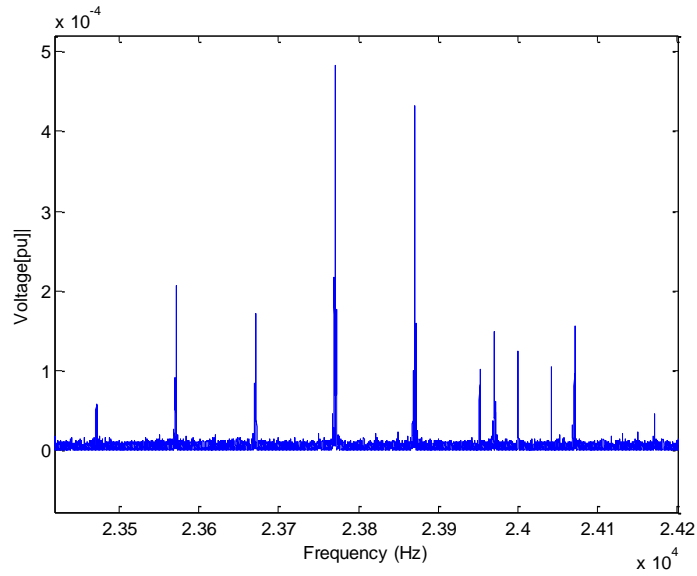

Figure 22: Frequency spectra for high frequency voltage noise at medium production

Figure 23 shows the spectra for the current harmonics. As can be seen the level of harmonics is noticeably lower than in the low production case.

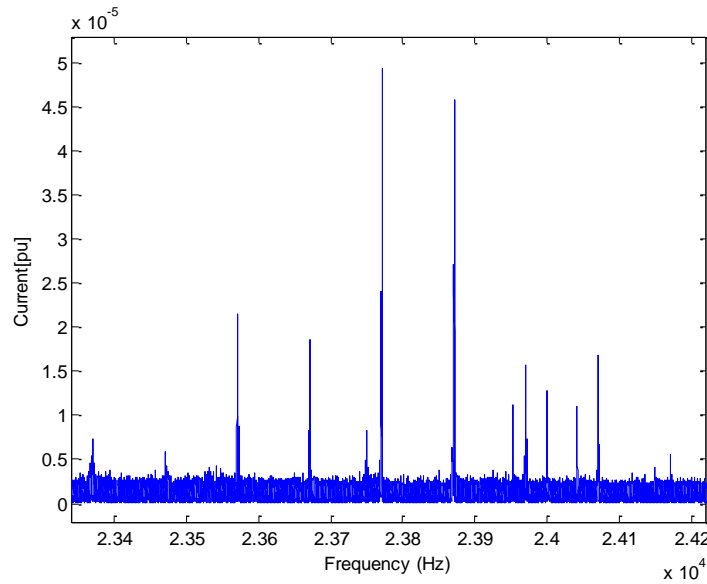

Figure 23: Frequency spectra for high frequency current noise at medium production

3.4.1.3 High production

Finally we look at a case of high generation, in this case around 2.05MW which is actually slightly over the rated maximum power production of 2MW. Once again we have a look at the current and voltage curve starting with the voltage. We have a look at the zoomed curve in Figure 24, as can be seen the noise level is comparable to previous cases and to part them is difficult. We turn to the voltage THD which in this case is 1.59% confirming the similarity to previous measurements. It seems as the voltage noise is not affected very much by the production level.

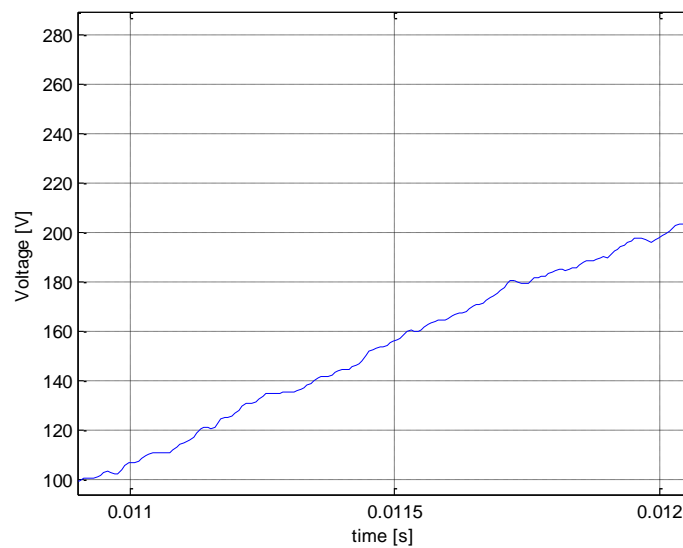

Figure 24: Zoom of voltage at high production

We move focus to the current, Figure 25 shows the wave forms of the current at high generation level. As can be seen the curve is still significantly better than at low generation but by visual inspection it appear comparable to the medium production case.

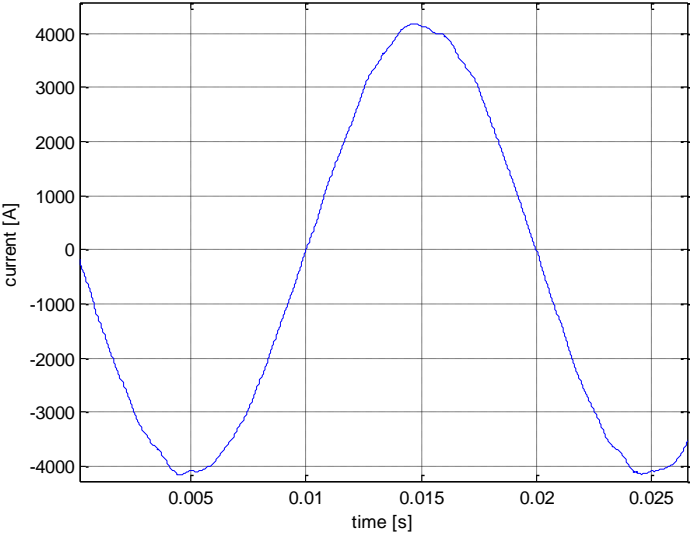

Figure 25: Current at high production

In the zoom of the current in Figure 26 it can be seen that the current is close to perfection which is confirmed by the current THD which in this case is 0.69%.

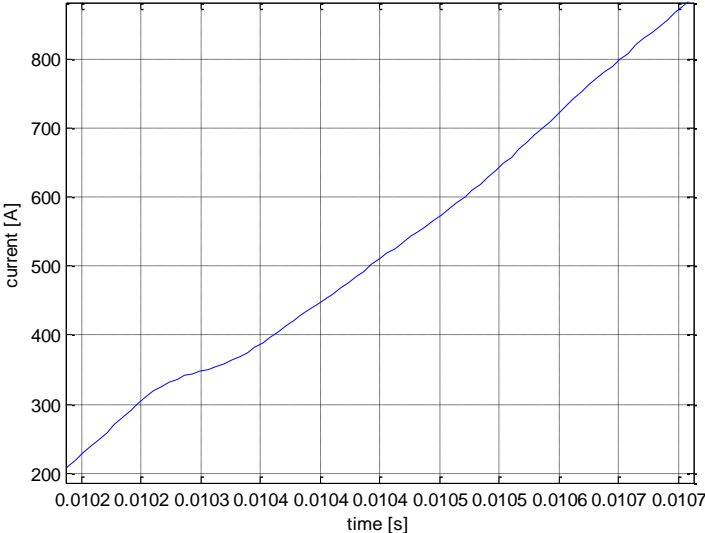

Figure 26: Zoom of current at high production

In the frequency spectra of the voltage in Figure 27 it can be seen that the levels have once again risen a bit and is higher than for medium production but lower than in the low production case. This is in line

with the previous mentioned the voltage noise does not have a clear relation to the production level. Figure 28 shows the frequency spectra for the current at high production. As can be seen the level of high frequency noise is lower than in the medium production case but still most definitely comparable.

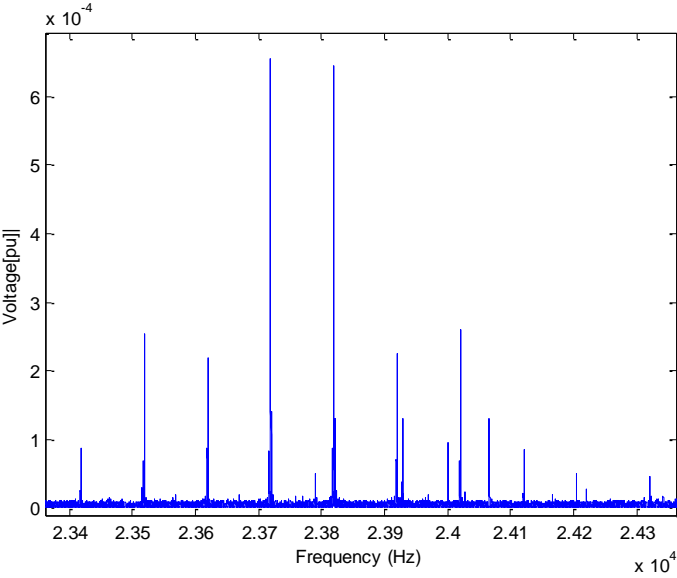

Figure 27: Frequency spectra for high frequency voltage noise at high production

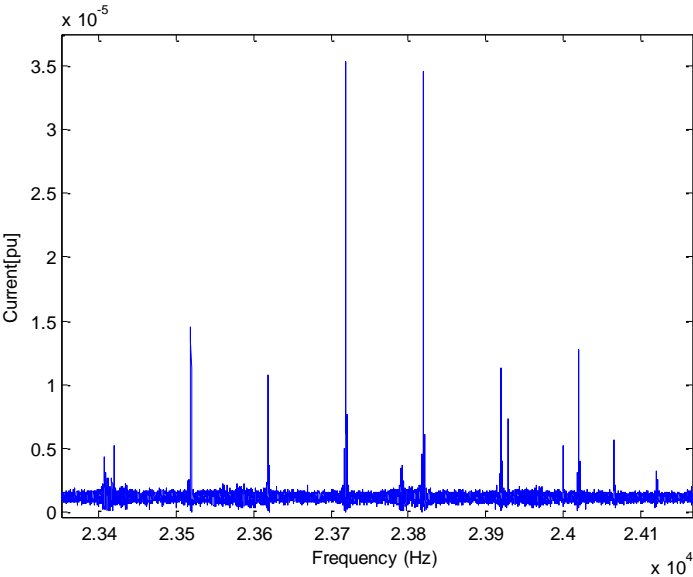

Figure 28: Frequency spectra for high frequency current noise at high production

3.4.1.4 Results from the Enercon E82 measurements

The first obvious result of this measurement is the fact that the transformer improves the power quality marginally through filtering out the third harmonic; this is seen when looking at the THD before and after the transformer. The improvement is clear looking at the numbers but in reality it is marginal.

Having stated this, we move on to looking at the power quality at different generation levels, starting with the voltage THD. No voltage THD level pattern can be detected for the low-, medium- and high generation measurement. As earlier implied it seems clear that the voltage harmonics are not affected by the production level, it can also easily be stated that the voltage THD in all cases is very low. The highest value mentioned in section 3.5.1 is 1.63%, which is very low. As earlier mentioned the maximum allowed voltage THD is 8% which gives a good frame of reference to the level in this particular measurement.

Current THD has greater variation between power levels; to get a better view of how much distorted power that is induced it is important to refer the current THD to the power level. This will now be done in the form of a simple calculation:

$$\text{Total power production} * \left(\frac{THD}{100}\right) = \text{Referens value for distorted power} \quad (2)$$

If we use this (2) for comparison purposes we get a distorted power value of 6.217kW in the low production case, a value 9.898kW in the medium production case and a value of 14.232kW in the high production case. This brings the current THD values better in to perspective, at low production the amount of distorted power induced on the grid is very small and even if it is higher for the higher production cases the values are still low.

If we now observe the high frequency noise and have a look at Figures 17, 18, 22, 23, 27 and 28, we see that all the high frequency noise for the voltages are at approximately the same level whereas the high frequency noise for the current follows a pattern and is decreased with increasing power level. This decrease is very clear.

3.4.2 Measurement at Enercon Wind turbine E53

The second measurement is done on an Enercon E53 wind turbine, presented in Figure 29. The E53 has a rated power of 800kW and an output voltage of 400V.



Figure 29: Enercon E-53 wind turbine

The method and measurement point is the same as in the previous case of the E82. The probes are once again connected to the conductors and the measurement is performed over a week. The aim of the measurement is once again to find the level of harmonics inserted into the grid by the turbine.

3.4.2.1 Low production

For this turbine we start by looking at a production of 24kW which is approximately 3% of the maximum production of 800kW. In Figure 30 we see a full period curve of the voltage.

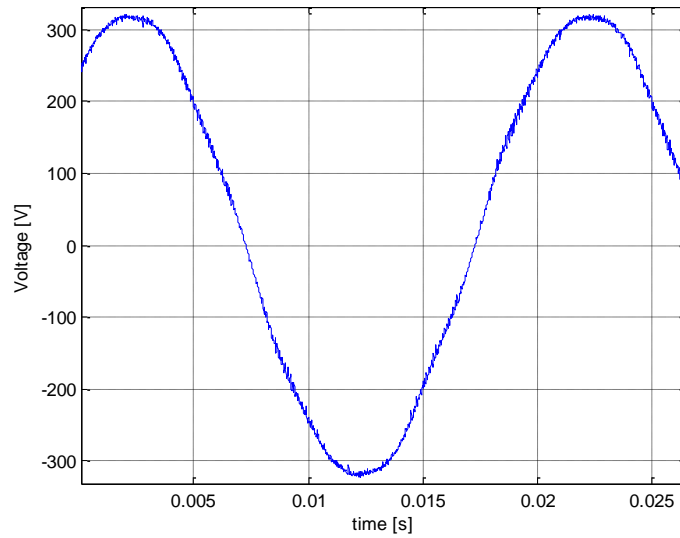

Figure 30: Voltage at low production

Already in the first graph it can be noted that the voltage produced by this turbine is of a poorer power quality than the quality of the E85. To get a better look we look at the zoom in Figure 31.

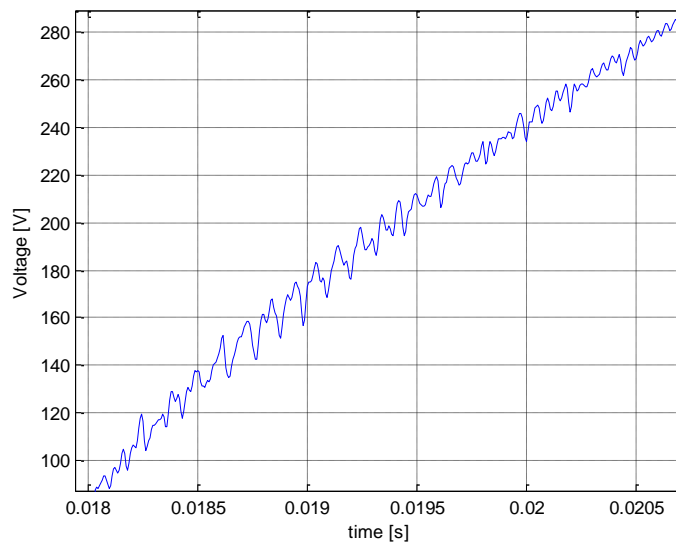

Figure 31: Zoom of voltage at low production

Figure 31 gives us another indication that the quality is not as good. To get it confirmed we have to take a look at the voltage THD which in this case is 1.83% confirming what the figures showed.

We turn to the current and look at the full phase wave form in Figure 32, which again at low production gives us a quite distorted current.

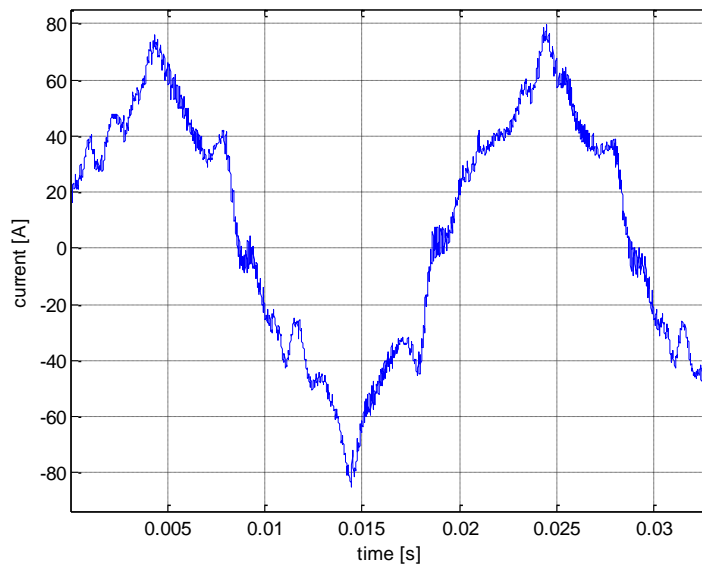

Figure 32: Current at low production

In the zoom of Figure 33 we get a further view of the level of distortion, to make it final we look at the current THD which in this case reaches the high level of 15.87%. However as earlier mentioned we must not forget that the generation level is low giving us a small amount of noise actually emitted to the grid.

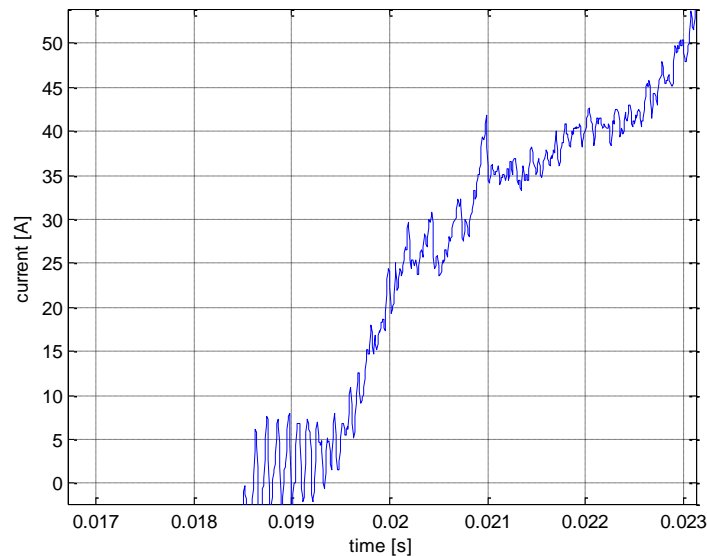

Figure 33: Zoom of current at low production

We now have a look at what kind of high frequent noise the E53 produces; in Figure 34 these voltage harmonics can be seen.

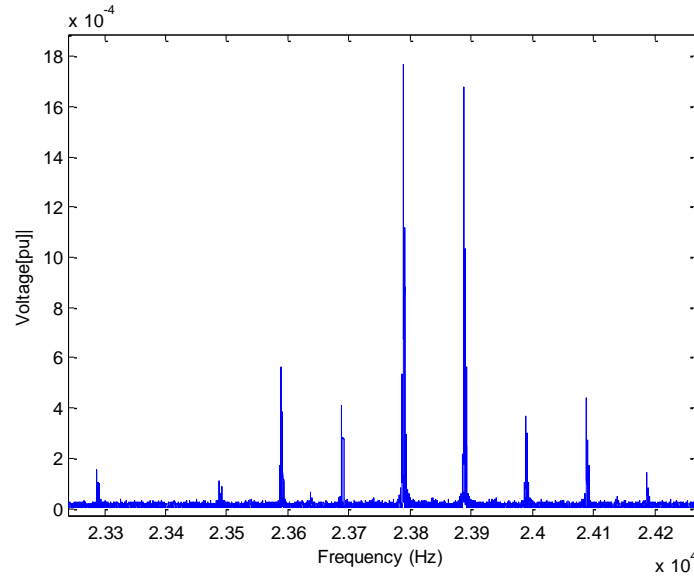

Figure 34: Frequency spectra for high frequency voltage noise at low production

As can be seen in Figure 34 the high frequency noise is still located in the same region as before. In line with the THD level the level of these harmonics is approximately the double of the previous turbine. Figure 35 shows the frequency spectra for the current at low production, it also indicates that the E53 produces more harmonics than the E82.

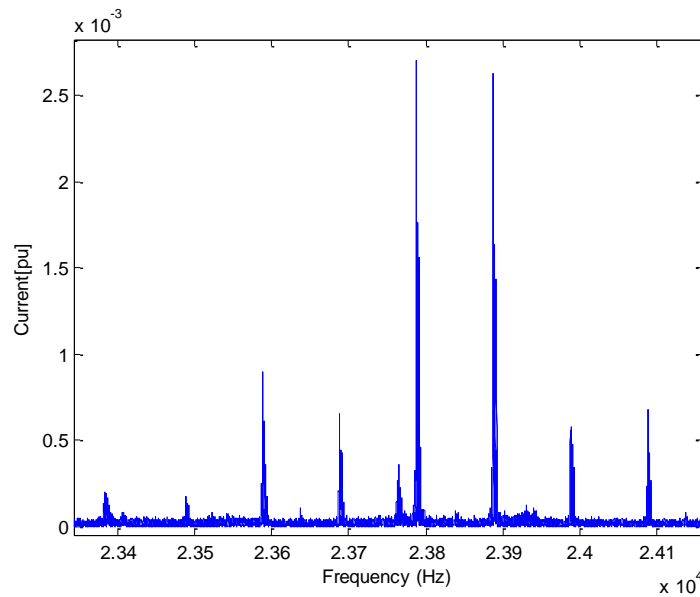

Figure 35: Frequency spectra for high frequency current noise at low production

3.4.2.2 Medium production

We now have a look at a measurement where the production was at medium level; in the selected case it is approximately 0.44MW which is 55% of the maximum production. We have a look at the zoom of the voltage in Figure 36.

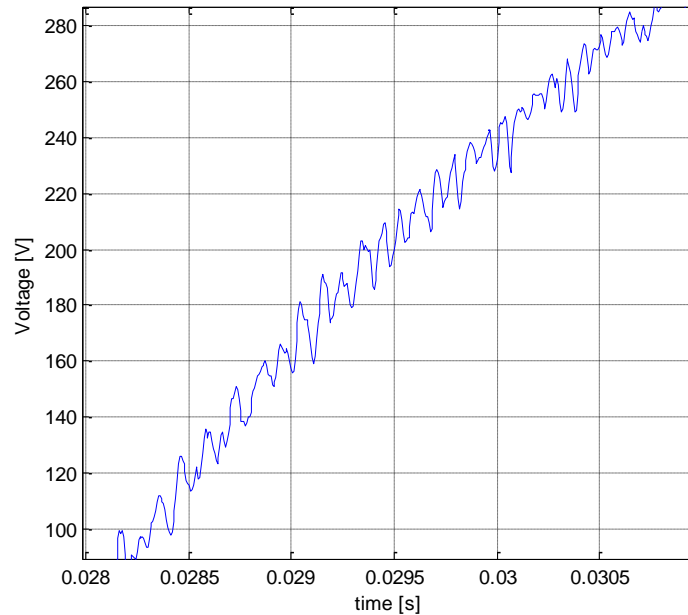

Figure 36: Zoom of voltage at medium production

As can be seen in Figure 36, once again a voltage with noise is obtained. But to get a better overview of the noise level we observe the voltage THD which in this case is 1.85 %. As anticipated the value is very close to the value retrieved from the low production measurement.

Looking at the current in Figure 37, as one may expect, we see an obvious improvement from the previous case. We look at the zoom in Figure 38 and see that there is still some noise but the improvement is evident. To get a further idée of the improvement we look at the current THD which in this case has improved drastically to a value of 1.46 %.

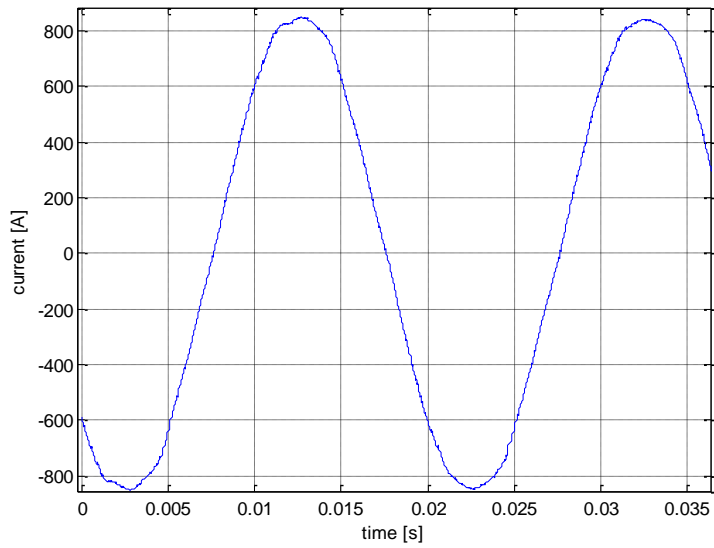

Figure 37: Current at medium production

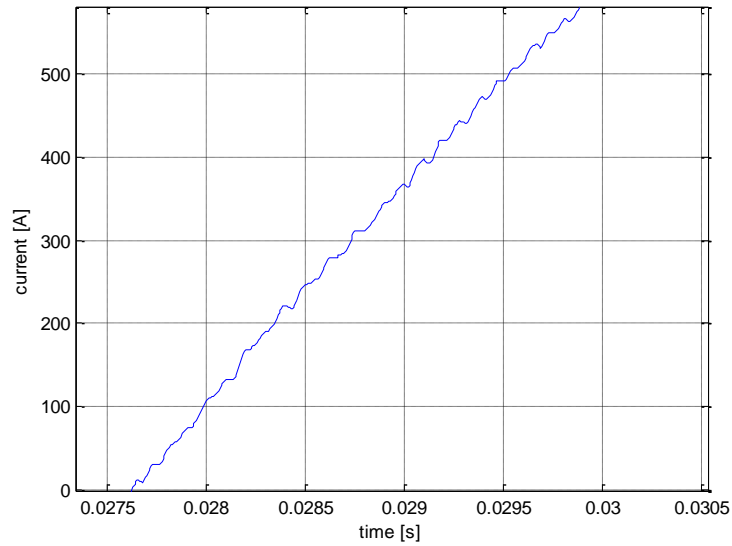

Figure 38: Zoom of current at medium production

Finally, the high frequency noise is observed in Figure 39 and Figure 40. Figure 39 shows the voltage noise which has a higher level of voltage than the previous case. Figure 40 shows the high frequency harmonics for the current which also have a higher level than the low production case.

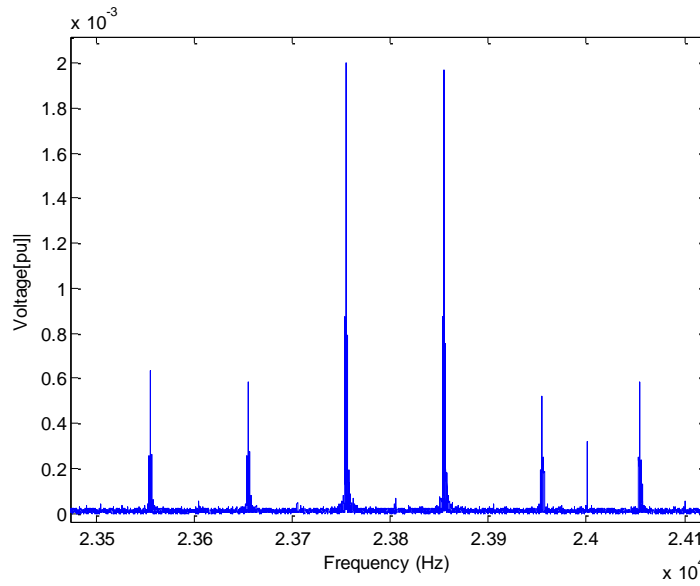

Figure 39: Frequency spectra for high frequency voltage noise at medium production

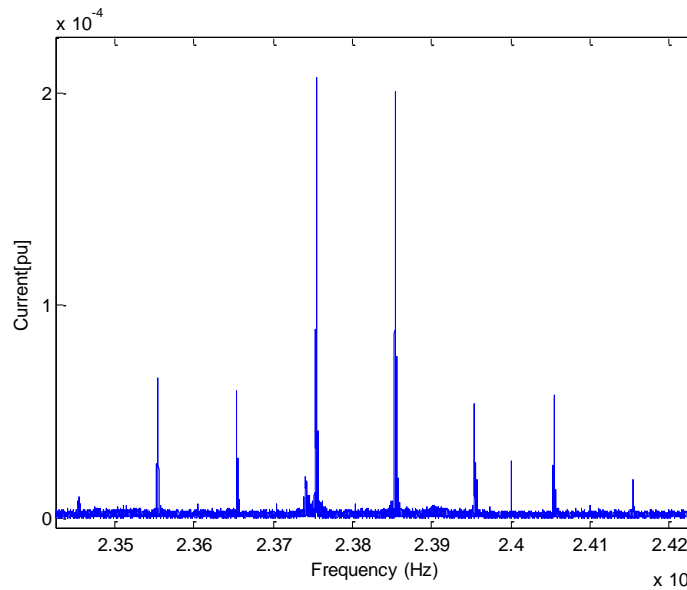

Figure 40: Frequency spectra for high frequency current noise at medium production

3.4.2.3 High production

We now look at a case where the production is approximately 830kW which is over the rated maximum power of 800kW. Looking at the voltage zoom of Figure 41 it is difficult to see any difference from

previous measurements so we look at the THD 1.59% which is a bit lower than in previous measurements.

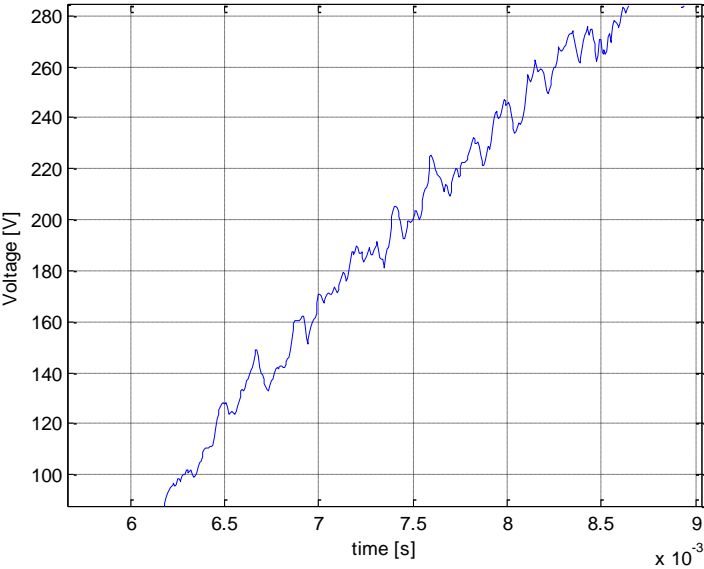

Figure 41: Zoom of voltage at high production

Observing the current of Figure 42 we see a quite clear current. Figure 43 which present the zoom of the current shows it as nearly perfect. Having a look at the current THD we get this confirmed as it is only 0.73 %.

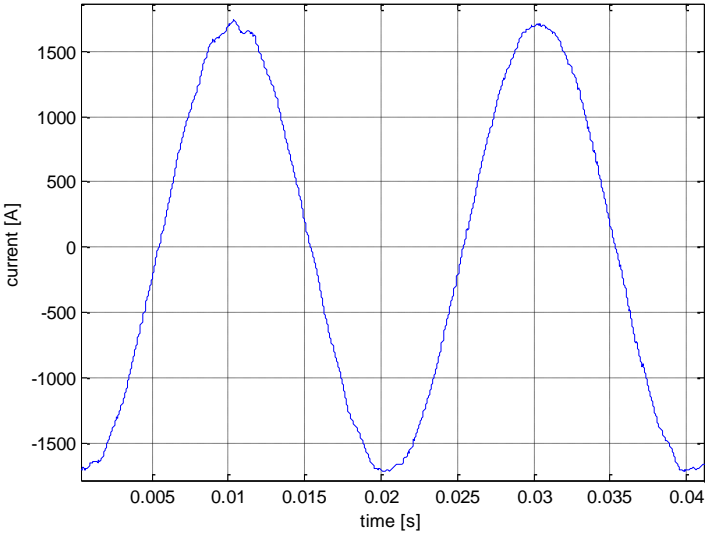

Figure 42: Current at high production

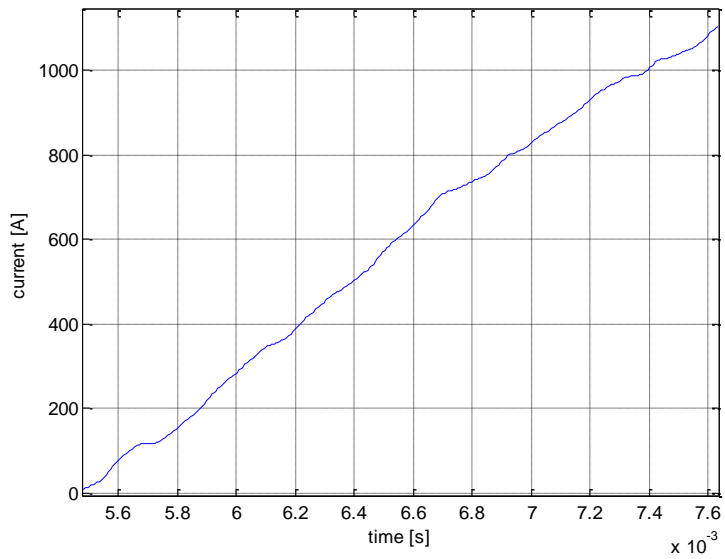

Figure 43: Zoom of current at high production

Looking at the high frequency noise of the voltage in Figure 44 we see that the level once again remains approximately at the same level as in previous cases. On the other hand, looking at the high frequency noise of the current in Figure 45 we see that the current also follows its pattern and is decreased.

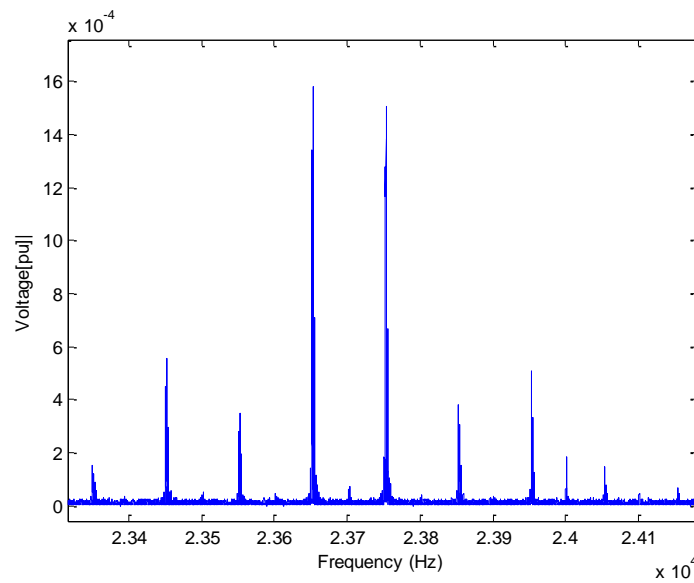

Figure 44: Frequency spectra for high frequency voltage noise at high production

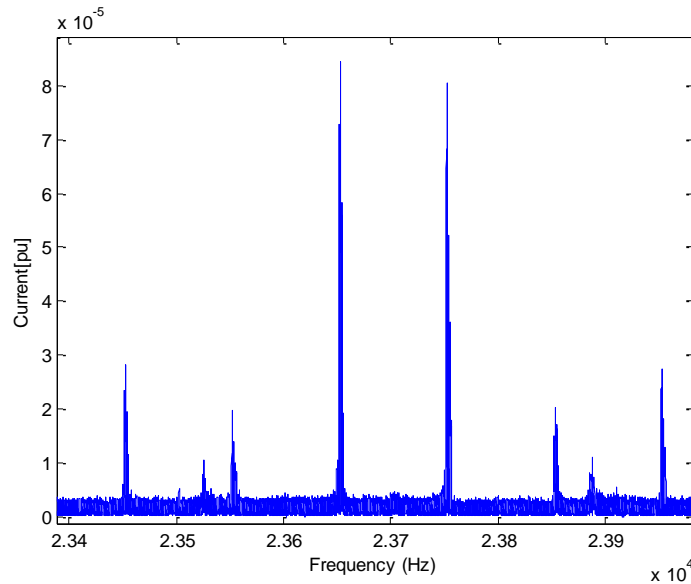

Figure 45: Frequency spectra for high frequency current noise at high production

3.4.2.4 Result from the Enercon E53 measurements

The voltage THD stays at approximately the same level independent of the power level. In a comparison between the two different turbines it can be stated that the THD value is generally slightly higher for the E53 than for the E82 with a highest value of 1.85 %.

Looking at the current THD, we once again see a high value for the low production case. But as in the case of the E82, the current THD is drastically reduced in the cases of higher production. To get a more accurate value of the actual effect of the current THD we once again, for comparison purposes, observe the reference value retrieved by the Equation 2. The amount of distorted power in the low generation case is 3.808kW, in the medium production case it is 6.403kW and in the high production case it is 6.066kW. This shows us that the actual amount generated distorted power is always low.

We now have a look at the high frequency noise and consequently observe Figures 34, 35, 39, 40, 44 and 45. Here we see that the high frequency noise for the voltages once again stay in the same region independent of the power level while the high frequency noise for the current is decreased with an increasing power level.

Now that we have looked at the noise both for the E82 and the E52, it can be stated that voltage noise is not affected by the production level. The current noise is closely related to it, even though the actual level of distributed distorted power is also rather independent of the production level.

3.4.3 Measurement at Point of common coupling

The next step is to investigate how the harmonics from the wind turbines are affected by the transmission from the turbines to the point of common coupling. Here the measurements are performed at 20kV. The measurements are also performed under different operation conditions to see if the harmonic levels can be affected by changing them. For security reasons these measurements were all performed over a short period of time and therefore the power variation between measurements is not large. The maximum power level of the connection on the 20kV measurement point at the point of common coupling is 16MW which is not reached during the performed measurements.

3.4.3.1 Normal operation, 20kV

The first measurement is performed under normal operation conditions. As can be seen in Figure 46 and in Figure 47 the high voltage probe is placed directly on the conductor on the 20kV side. However the current measurement was for security reasons in this case not performed directly in the conductors but on a current transformer with an unknown bandwidth. This leaves us with a current measurement result that can only be used for calculating power and not for finding current harmonic levels.

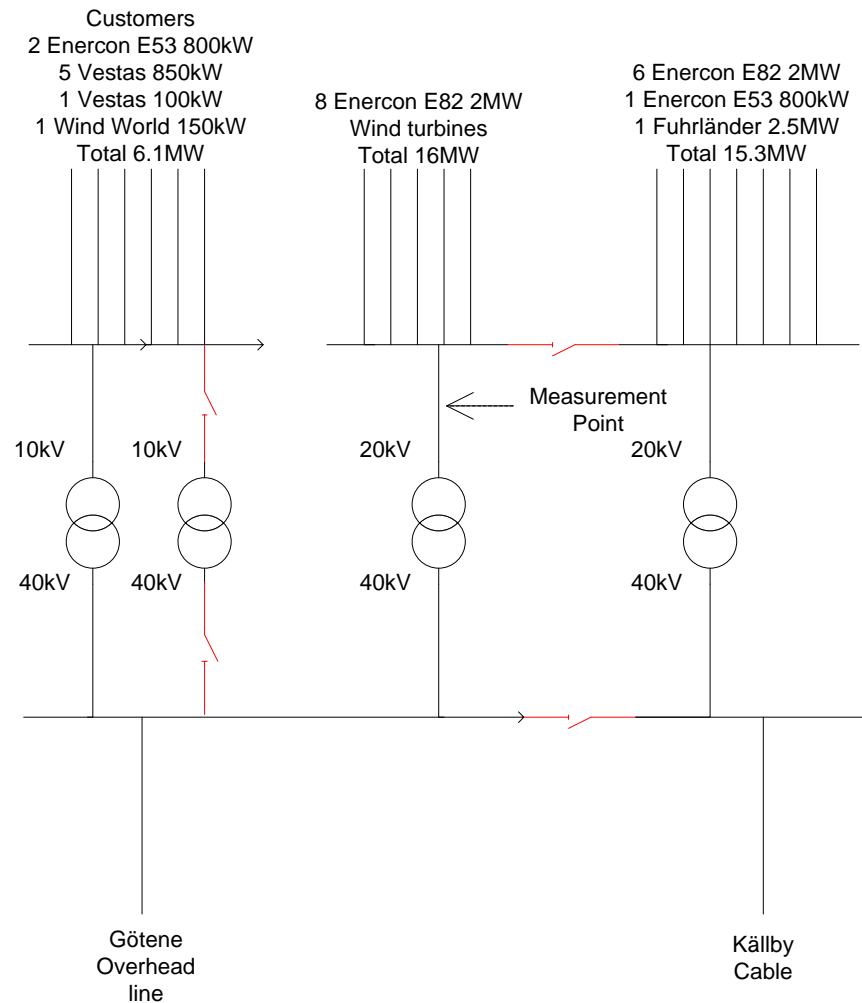

Figure 46: Structure of the M3 switchgear station under normal operation with marking of measurement point

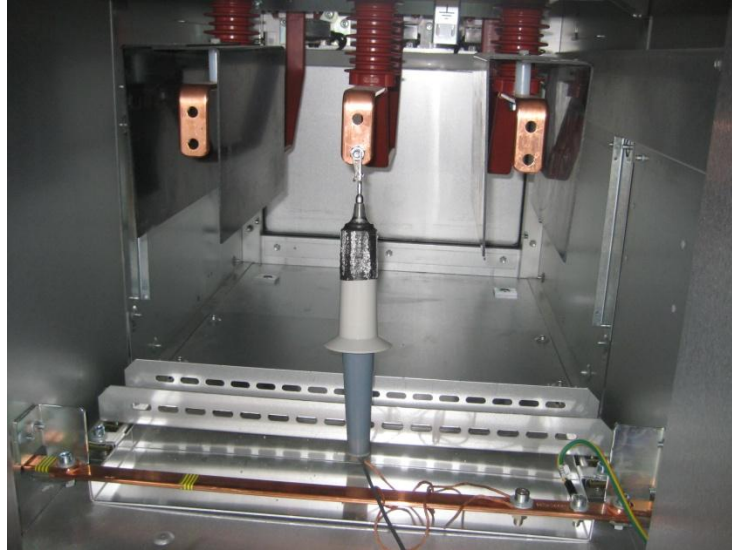

Figure 47: High voltage probe connected to the conductor in M3 on the 20kV side

However, we can still analyze the voltage. Let's observe a case with a power level of approximately 6.88MW. Figure 48 shows a full period curve of the voltage, which is almost a perfectly sinusoidal curve. Observing Figure 49, we see a zoom of the same voltage. The voltage curve is almost perfect and the noise is negligible.

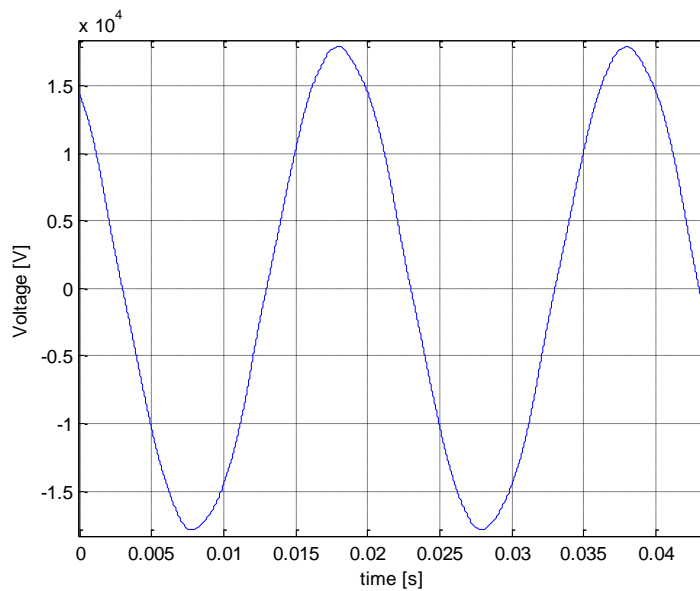

Figure 48: Voltage on the 20kV side of M3 under normal operation

To get final confirmation of the quality of the voltage we calculate the voltage THD which is 1.27%.

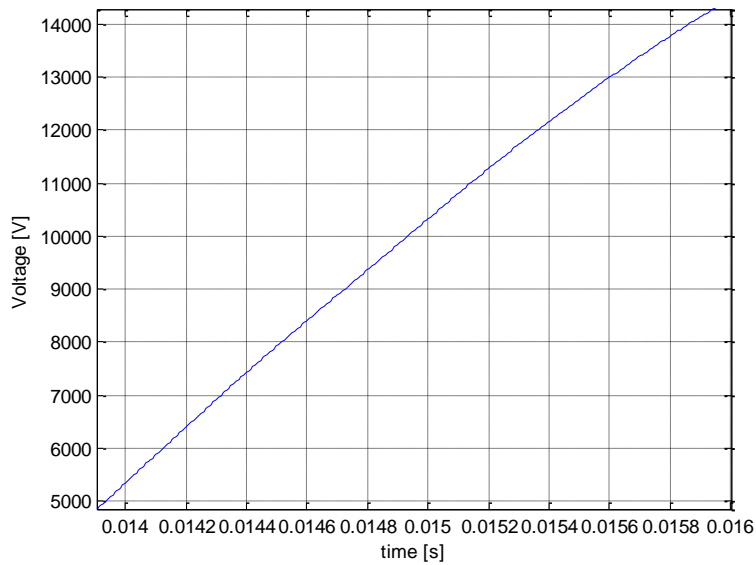

Figure 49: Zoom of the voltage on the 20kV side of M3 under normal operation

Observing the frequency spectra around 23.8 kHz in Figure 50, a low level of harmonics can be seen.

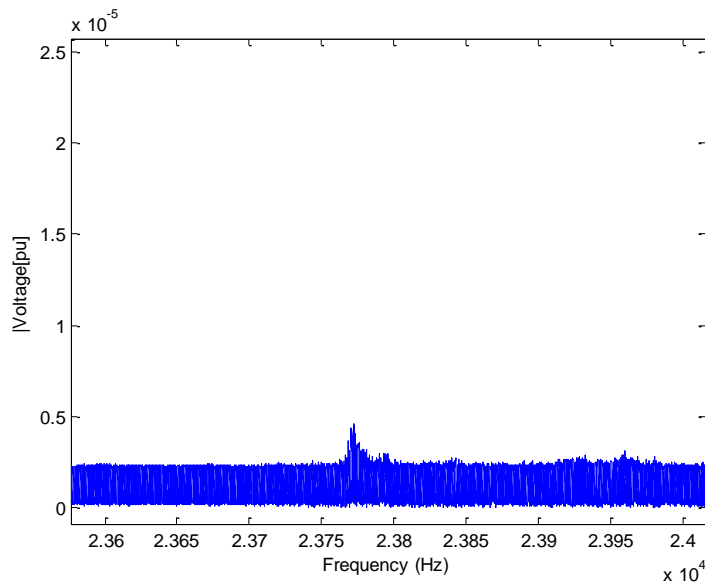

Figure 50: Frequency spectra for high frequency voltage noise on the 20kV side of M3 at a power level of 6.88 MW

For the sake of a comparison, we look at the THD and frequency spectra for one more measure point. This time a power level of approximately 6.47MW at the point of common coupling is chosen. The voltage THD at this point is 1.24% and the frequency spectra for higher frequencies can be seen in Figure 51.

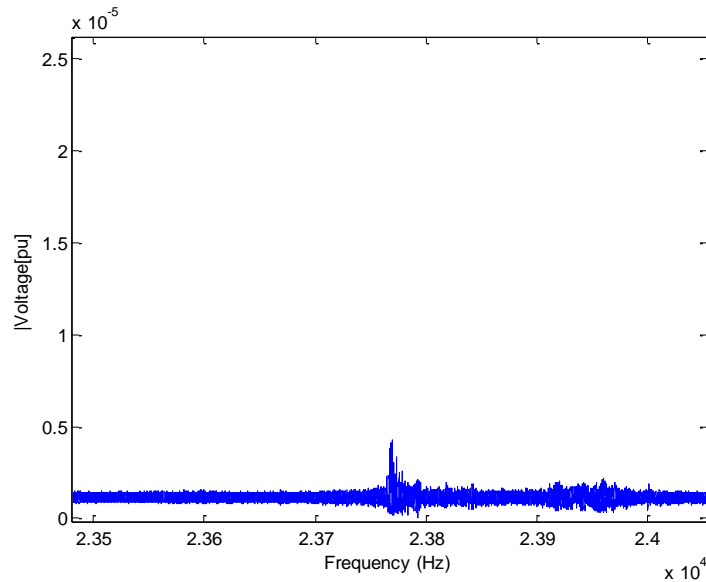

Figure 51: Spectra of high frequency voltage noise on the 20kV side of M3 at a power level of 6.47 MW

3.4.3.1.1 Results: Induced noise level compared to noise level at point of common coupling

In this section a comparison between the noise level induced from the turbines and the noise level that reaches the point of common coupling is performed. For the THD the total level of produced THD is calculated through finding the percentage of production of each turbine corresponding to the level measured at the point of common coupling. It is assumed that all turbines of the same type produce the same level of harmonics. A total THD value is then calculated by solving (2) for the full power of the wind farm. This gives us the total produced voltage THD for all wind turbines in the 20kV grid.

Before all this we need to find a suitable measurement from the point of common coupling. One of the measurements of section 3.5.3.1 is used; this point has an approximate power level of 6.9MW and a THD of 1.27%. Figure 50 shows the frequency spectra for higher frequencies at this power.

After stating these values, we get on with finding measurement points for the wind turbines corresponding to a level at common coupling of 6.9MW. The maximum power production of the turbines connected to the 20kV grid is 16MW. This means that at the chosen power level the power production is at approximately 43%, which shows that all wind turbines should operate at approximately 43% of their maximum production. This gives us a power level of 0.86MW for the Enercon E82. The measured value with the best correspondence to this value is 0.85MW giving us a total power production of 6.8MW which is only 1.45% lower than the value in the point of common coupling. The respective voltage THD levels at these levels are for the E82 1.27 %, this value is now used for calculating the total amount of distorted power using (2). The total level of distorted power from the different

turbines is then added and divided by the total amount of power giving us a total voltage THD for the whole wind farm of 1.27%. Since the voltage THD value at point of common coupling is 1.27%, one can see that the voltage THD is the same at the source as at point of common coupling.

The high frequency noise is presented in Figure 52, where a normalized value of the noise produced by the 8 Enercon E82 connected to this particular transformer in the 20kW grid can be seen.

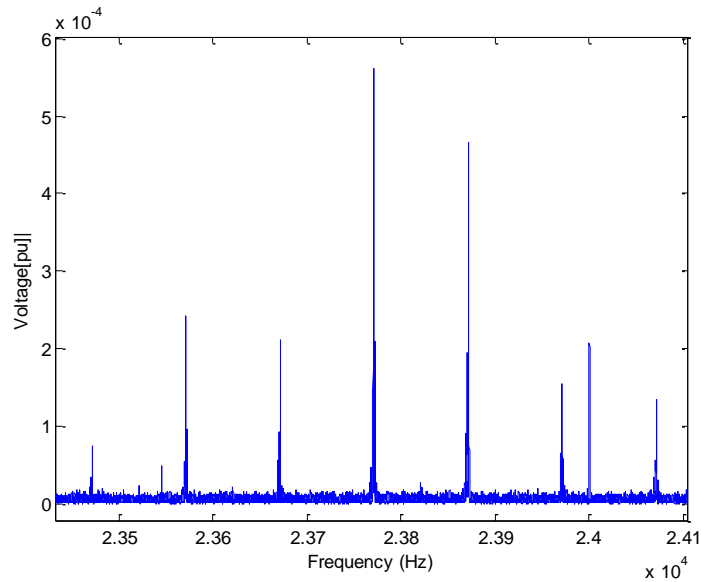

Figure 52: Frequency spectra of the high noise produced by the 8 Enercon E-82 at a production 6.8MW

For comparison reasons the high frequency spectra in Figure 50 is redrawn in Figure 61, this time in scale to Figure 53.

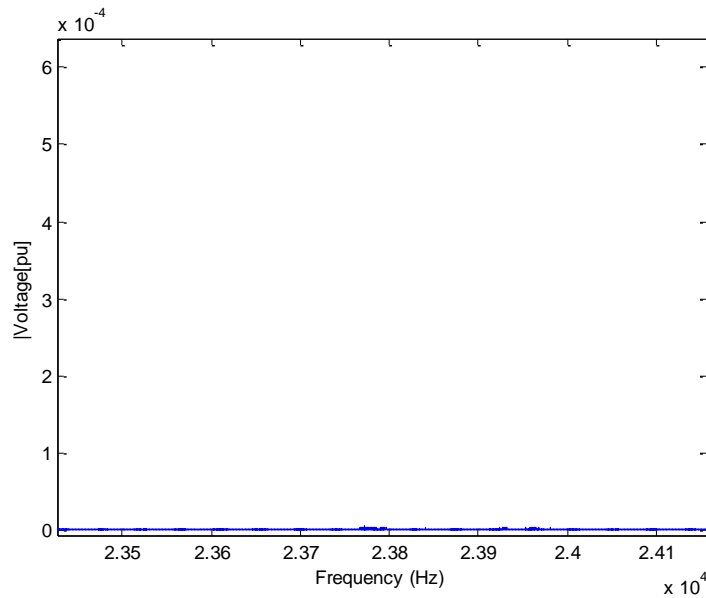

Figure 53: Frequency spectra for high frequency voltage noise on the 20kV side of M3 at a power level of 6.88 MW

When comparing Figures 52 and 53 it can be seen the high frequency noise produced by the wind farm is practically gone by the time it reaches the point of common coupling.

3.4.3.2 Decreased impedance, 20kV

In theory a reduction of impedance should lead to a reduction of voltage harmonics, according to Ohms law and the fact that voltage harmonics are directly caused by current harmonics.

$$U = Z * I$$

So a reduction in impedance should theoretically lead to higher power quality to the benefit for the consumers, it will however not affect the current harmonics. In our case this can be illustrated by the simplified scheme Figure 54, where Z_g the source impedance is decreased.

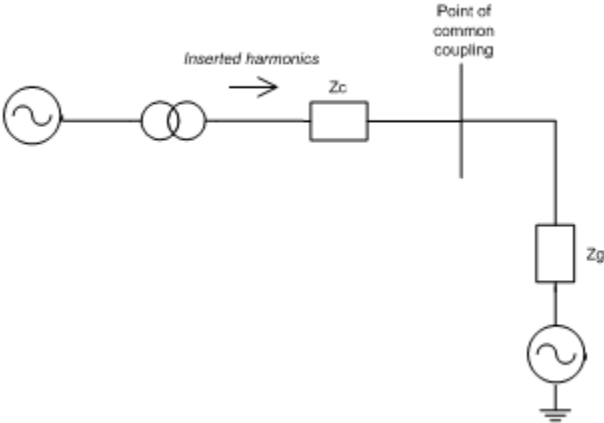

Figure 54: Simplified scheme of a wind power connection

The impedance reduction is archived through changing the normal operation conditions to the operation situation seen in Figure 55, where the outgoing lines of M3 are interconnected and parallel to each other.

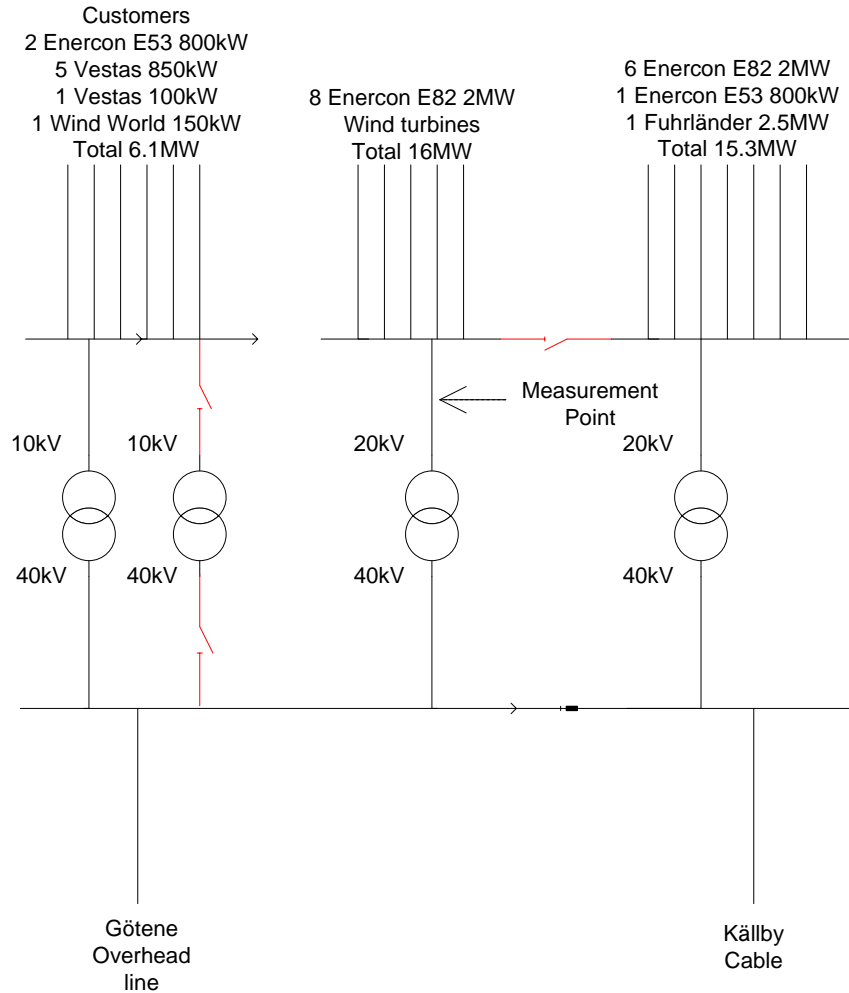

Figure 55: Structure of the M3 switchgear station when Götene and Källby are interconnected

We now find a measurement point with similar power level as in the second example of section 3.5.3.1. The chosen point has a power level of approximately 6.42MW. Figure 56 shows a zoom of the perfect voltage curve also supported by the THD value which here is 1.43%, actually not lower than the previous as was expected.

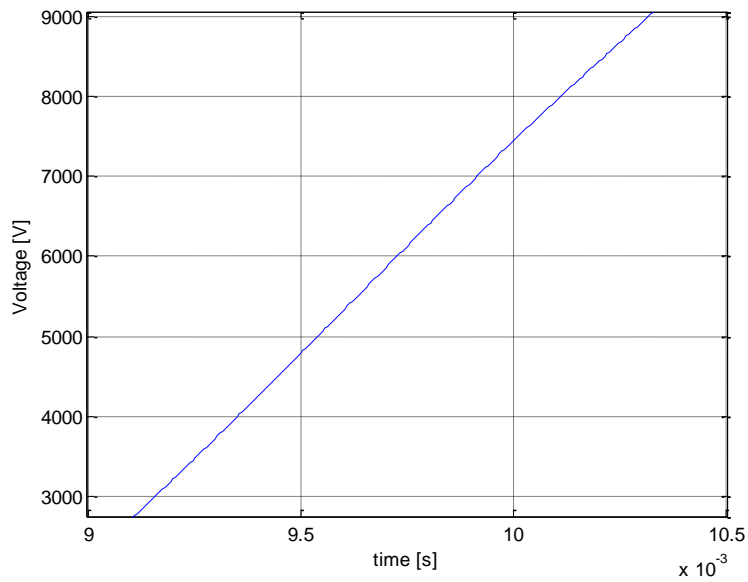

Figure 56: Zoom of the voltage at common coupling at decreased impedance

Now looking at the high frequency noise for this operation conditions in Figure 57 it is clear that the maximum level is comparable to the normal operation case.

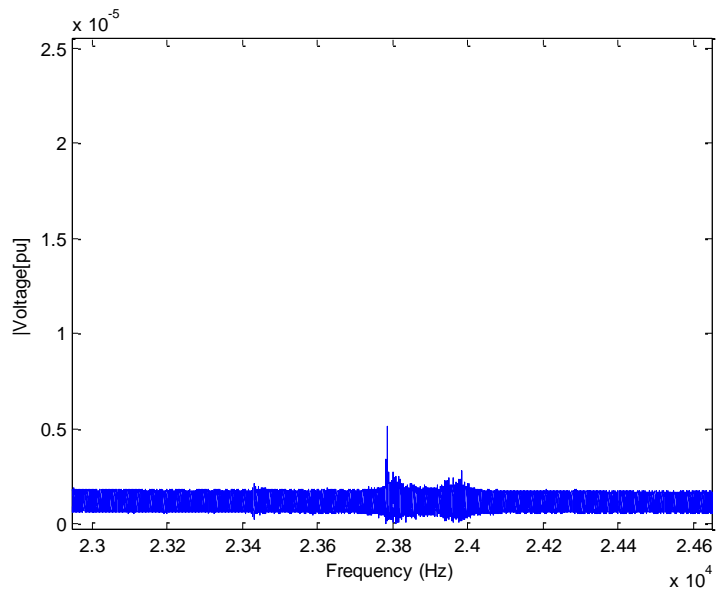

Figure 57: Spectra of high frequency voltage noise on the 20kV side of M3 at decreased impedance

3.4.3.2.1 Results: Decreased impedance, 20kV

The power level of this measurement is comparable to the second measurement of normal operation in section 3.5.3.1 where we have a power level of 6.47MW.

We start by looking at the voltage THD. Under normal operation it is 1.24% and after decreasing the impedance we actually get a higher value of 1.43%. Let us observe the high frequency noise and take a look Figures 58 and 59.

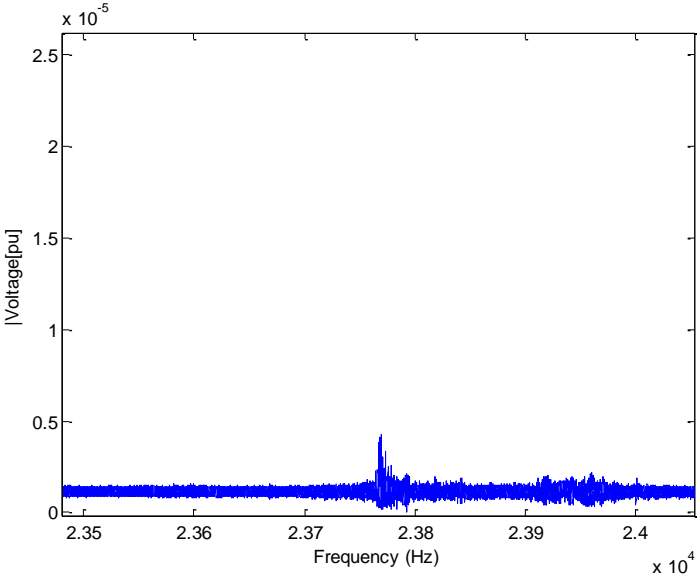

Figure 58: Spectra of high frequency voltage noise on the 20kV side of M3 at a power level of 6.47 MW at normal operation

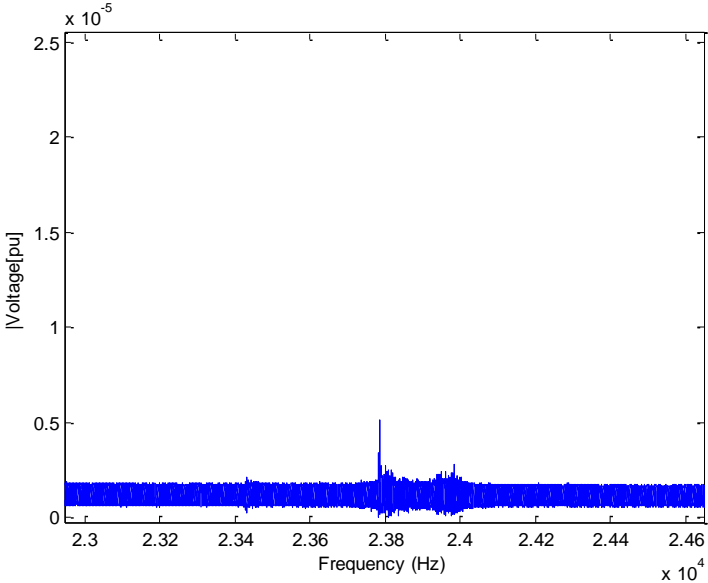

Figure 59: Spectra of high frequency voltage noise on the 20kV side of M3 at decreased impedance

When comparing Figures 58 and 59, it can be noted that the attempt to reduce the already small noise has not had the expected effect and the difference between the two operation conditions is negligible.

3.4.3.3 Disconnected Källby cable, 20 kV

This measurement is done as a reference to the next measurement; the purpose is to see what kind of effect a phase compensation capacitor has on the noise. The capacitor works as a low pass filter and should therefore decrease the noise level.

Now all production is directed towards Götene and cable to Källby is not in operation. We find a measurement with appropriate power level, a point with an approximate power level of 7.46MW. Looking at the zoom of the voltage in Figure 60, once again we see an almost perfect voltage curve with a voltage THD of 1.41%.

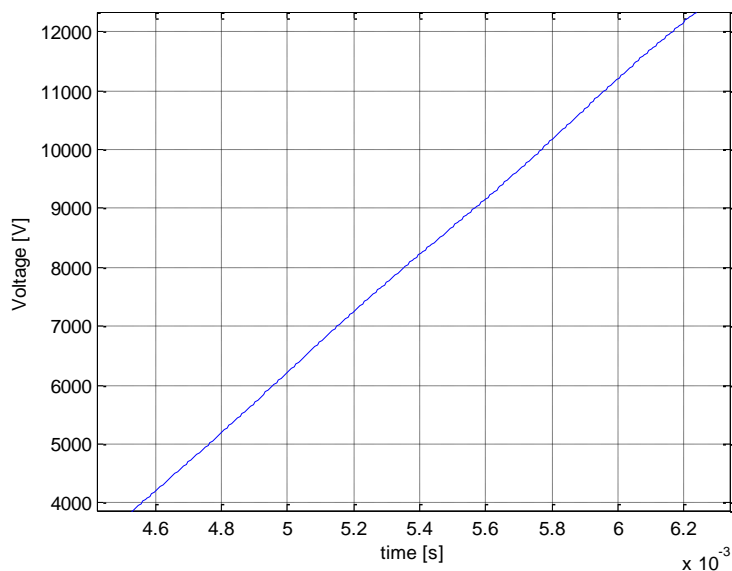

Figure 60: Zoom of the voltage at common coupling with disconnected Källby cable

Looking at the frequency spectra of the higher frequencies in Figure 61 we see a low level of noise.

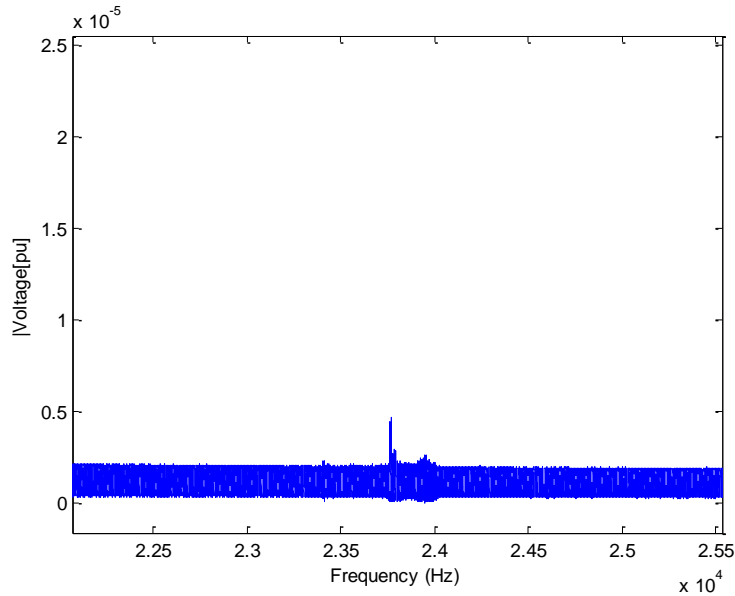

Figure 61: Spectra of high frequency voltage noise on the 20kV side of M3 with disconnected Källby cable

3.4.3.4 Disconnected Källby cable and phase compensation capacitor, 20kV

Now it is important to find a measurement with similar generation conditions to the previous section; the chosen measurement has a power level of approximately 7.5MW. We look at a zoom of the voltage in Figure 62 and see a clean voltage with a voltage THD of 1.40% a value at the same level as in the previous section.

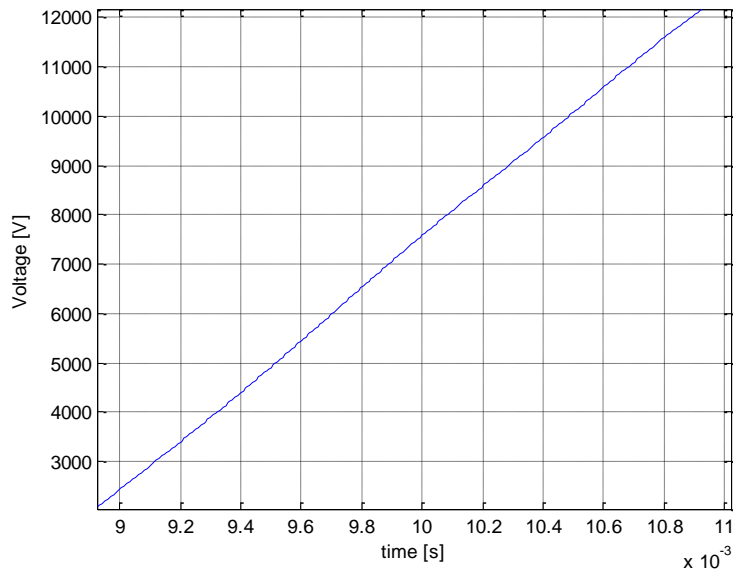

Figure 62: Zoom of the voltage at common coupling with disconnected Källby cable and phase compensation capacitor

When we now have a look at the frequency spectra in Figure 63 it is difficult to note any improvement from the previous measurement.

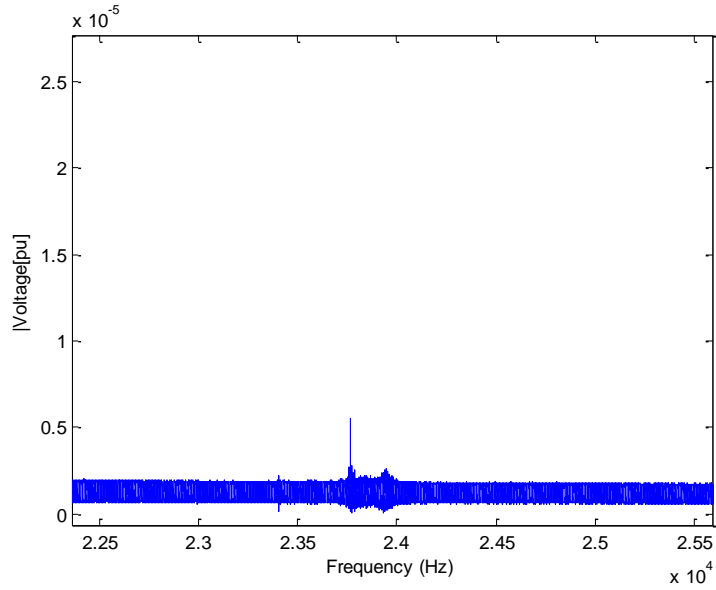

Figure 63: Spectra of high frequency voltage noise on the 20kV side of M3 with disconnected Källby cable and phase compensation capacitor

3.4.3.4.1 Results from disconnected phase compensation capacitor measurement

In the situation where the capacitor was disconnected the power was 7.5MW, which is well comparable to the first case, with a voltage THD 1.40%. This is a lower value than in the first case, where the voltage THD was 1.41, but the reduction is only 0.01 percentage points and barely worth mentioning. However looking at the normalized frequency spectra, in Figures 64 and 65, the noise in the higher frequencies is noted.

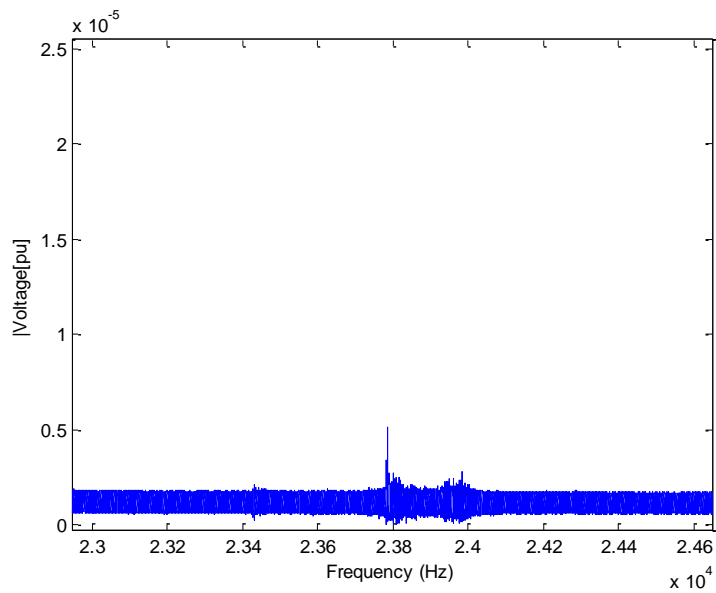

Figure 64: With phase compensation

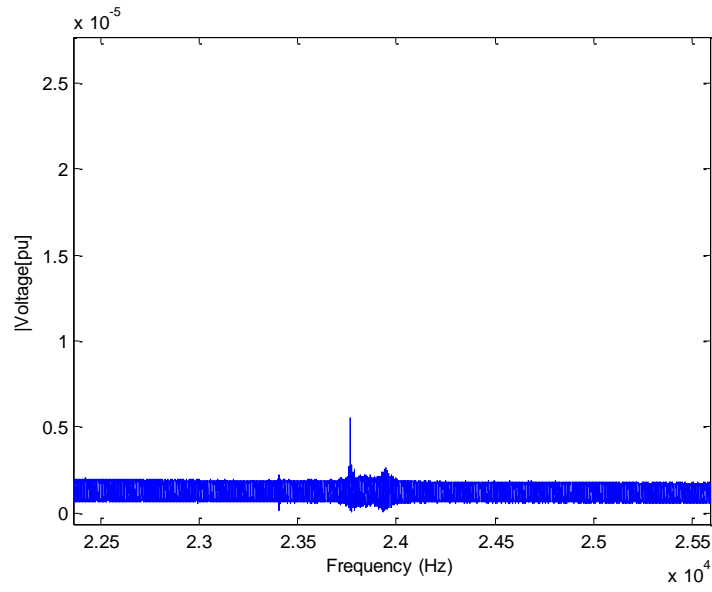

Figure 65: Without phase compensation

Comparing Figures 64 and 65, it can be stated that the efforts to improve the already high power quality showed marginal improvements.

4 Conclusions

The goal of this project is to investigate if the chosen method is adequate to study the influence of the increasing number of wind turbines in the electrical grid and thus high frequency harmonics. The purpose is also to investigate if the chosen method is adequate to evaluate if any means for harmonic mitigation are needed. This was done in steps; first, measurements were performed on the turbines to see the levels of noise injected to the grid by modern wind turbines. As it turns out, the power quality of the two wind turbines tested was well within the valid norms of a THD of 8% and had low levels of high frequency noise.

It was found that the voltage noise at all times was at a comparable level whilst the current noise was highly dependent of the power level. The significance of this was though proven to be little as the actual level of induced distorted power at all time was low.

Furthermore a series of measurements was performed at the point of common coupling starting with a measurement under normal operation. It was showed that the level of noise that reached the point of common coupling was insignificantly lower than at the generation point. It was also showed that the level of high frequency noise had decreased notably. It must be added that a source of error was introduced when finding comparable measurement points at the point of common coupling and at the wind turbines. The assumption that all wind turbines of the same type produce the same level of noise may also introduce some error.

Further, the goal was to investigate if the method is adequate to investigate means for harmonic mitigation at the point of common coupling. The investigation was performed by reducing the impedance at the point of common coupling by paralleling the two outgoing lines. It was also investigated if a phase compensating capacitor at the point of common coupling has any positive effects on the noise level. Both methods showed insignificant improvements. Once again error was introduced when finding comparable measurement points. The reason for the poor effectiveness was an already low noise level. These measurements would probably have been more interesting in an electrical environment with higher noise levels.

With the result of this work as foundation general noise and high frequency noise inflicted on the grid by wind power installations is not likely to cause serious problems for grid owners and consumers under current conditions.

As for the question if the used method is adequate for this sort of investigation, it appeared during the work that further investigations would be needed to obtain sufficient result to be able to make more general statements. The method used in this case can only give answers about harmonic levels under the current situation. It was also very difficult to investigate the effectiveness of means for harmonic mitigation as the levels were low.

5 Future Outlook

A way to improve the investigated method would be to stop and start the wind turbines minimum 10 times and measure at the point of common coupling. This would give a better picture of what levels of harmonics the different turbines actually delivers to this point. This result would give a better possibility to evaluate the future outlooks for the wind park. In order to investigate means for harmonic mitigation, this must be done under different conditions with all adequate power levels.

As mentioned, noise is not only injected in to the grid by production facilities, but also by consumers drawing an uneven current from the grid, this is a very interesting angle of a future noise investigation. The power produced at various production facilities is quite easily controlled and kept at an acceptable level while consumers are free to use equipment that may or may not have been controlled and accepted from a THD point of view. Noise produced by consuming equipment is also harder to handle simply because of logistics; the noise is generally very close to other consumers.

6 References

- [1] http://ec.europa.eu/energy/renewables/studies/doc/wind_energy/2001_fp5_brochure_energy_env.pdf (acc. 2011-08-18)
- [2] Mohan, Undeland, Robbins: POWER ELECTRONICS, CONVERTERS, APPLICATIONS AND DESIGNS Third edition 2003 John Wiley & son Inc
- [3] Erdman, J.M.; Kerman, R.J.; Schlegel, D.W; Skribinski, G.L.; "Effect of PWM Inverters on AC Motor Bearing Currents and Shafts Voltages", IEEE Transaction on Applications, Vol 32, No 2, 1996.
- [4] Mäki-Ontto, P.; "Modelling and reduction of shaft voltages in ac motors fed by frequency converters", Doctoral thesis Helsinki University of Technology, 21 April, 2006.
- [5] Voss, G.; Mattatia, S.; and Bajong, G.; "Interaction between power electronic and transformers-Risk evaluation and mitigation techniques", presented at the 18th International Conference on Electricity Distribution Turin, 6-9 June 2005, Paper no. 477
- [6] Paulsson, L.; Ekehov, B.; Halen, S.; Larsson, T.; Palmqvist, L.; Edris, A-A; Kidd, D.; Keri, A.J.F.; Mehraban, B.; "High-Frequency Impacts in a Converter-Based Tie; The Eagle Pass Installation", IEEE Transactions on Power Delivery, volume 18, Issue 4, Oct. 2003.
- [7] Selander, L.; Mortensen, T. I.; Lindell, G.; "Load Profile and Communication Channel Characteristics of the Low Voltage Grid", Proc. DistribuTECH DA/DSM Europe 98, London, U.K., 1998.
- [8] Stein, U.; "Signalöverföring på lågspänningsnätet", SP, April 2006, Elforsk rapport 06:22.
- [9] Lidberg, M.: "PE system in electrical sensitive environmental", Skellefteå, Sweden, Luleå University, Skellefteå Campus, 1994.
- [10] Swedish standard SS-EN 50160, Voltage characteristics of electricity supplied by public distribution systems.
- [11] <http://www.enercon.de/en-en/62.htm> (acc. 2011-08-16)
- [12] <http://www.enercon.de/en-en/59.htm> (acc. 2011-08-16)